

P	LYR	DESCRIPTION	DATE	DWN	APVD
	A	RELEASE FOR PRODUCTION	18-04-00	AJB	-
	A1	WIRE & INSULATION RANGE INFO ADDED	15FEB2012	PKS	RRP

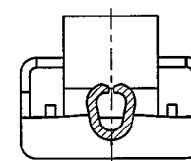

SECTION X-X

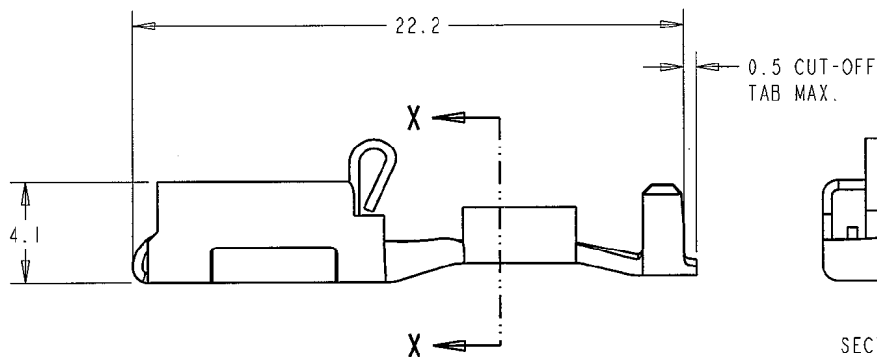
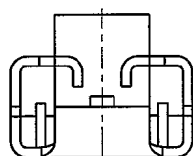
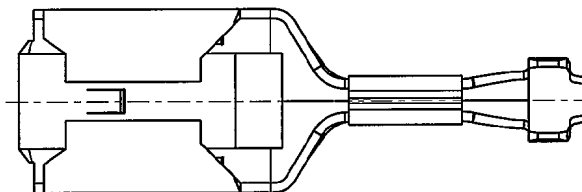
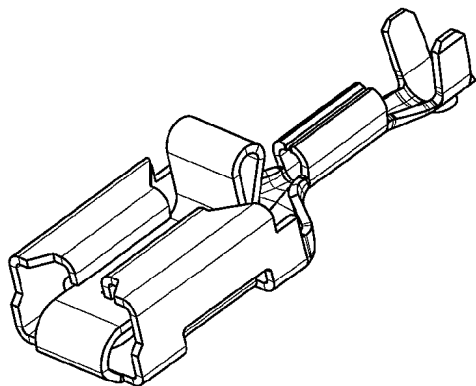
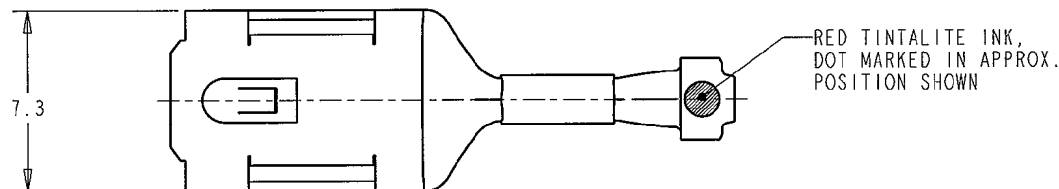
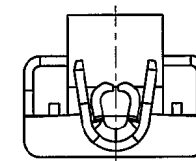

- BRASS, GOLD PLATED ALL OVER TO DEF STD. 03-17
HARD GOLD 2.5µm MINIMUM, OVER COPPER 2.5µm MIN
- PACK SIZE : 500/BOX
- WIRE RANGE : 0.3-0.81 sq.mm (22-18 AWG)
INSULATION RANGE : 1.1-2.5 mm DIA. (.045"-.100" DIA.)
- NET WEIGHT : 1.02g

THIS DRAWING IS A CONTROLLED DOCUMENT FOR AMP INCORPORATED. IT IS SUBJECT TO CHANGE, AND THE CONTROLLING ENGINEERING ORGANIZATION SHOULD BE CONTACTED FOR THE LATEST REVISION.		DWN A. J. BEKEN 18-Apr-00	1337265-1 PART NUMBER		
DIMENSIONS IN m.m	TOLERANCES UNLESS OTHERWISE SPECIFIED:	CHR R. GOODALE 18-Apr-00	TE Connectivity		
THIRD ANGLE PROJECTION	LINEAR: - ±0.5 ANGULAR: - ±1°	APVD FCW 18-Apr-00	NAME POSITIVE LOCK RECEPTACLE .250 SERIES FOR 0.8 TAB, GOLD PLATED, LOOSE PIECE		
MATERIAL SEE NOTE	FINISH SEE NOTE	PRODUCT SPEC 108-3017	SIZE A3	CAGE CODE 00779	DRAWING NO C=1337265
		APPLICATION SPEC 114-2153	SCALE 5:1 SHEET 1 OF 1 REV A1		
		WEIGHT -	CUSTOMER DRAWING		