

RS232C/RS485 Data can be easily monitored by LAN

KS1 SIGNAL CONVERTER



FEATURES

- The connectors are located on the front panel. Easy to connect
- Easy to operate
- Can be connected to the LAN without the need of switching between RS232C and RS485 signals
- Easy-to-install DIN-rail-mountable type

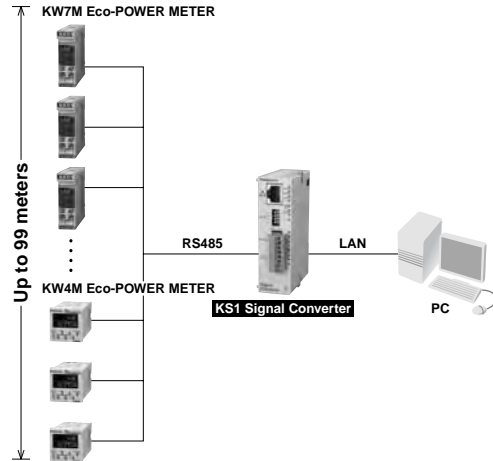

Compliance with RoHS Directive

PRODUCT TYPES

■ Main unit

	Rated voltage	Signal conversion specifications	Model number
KS1 Signal Converter	24 V DC	Ethernet ↔ RS232C/RS485	AKS1202

■ Options

Product name	Descriptions	Model number
Power supply unit for FP0	Input: 100 to 240 VAC, Output: 24 VDC, 0.7 A	AFP0634
Power supply cable for FPΣ*	1 piece, 1 m length	AFPG805
Screwdriver for terminal block	Using when wiring Phoenix terminal	AFP0806

* Included with product

■ Setting software

Product name	Descriptions	Remarks
Configurator WD	IP address searching tool software for KS1	You can download from our website (free of charge)*

■ Manual

Product name	Descriptions	Remarks
KS1 Signal Converter User's manual	Detailed explanation of KS1 Signal Converter usage (pdf)	You can download from our website (free of charge)*

* Customer registration is required to download data.

KS1 SIGNAL CONVERTER (AKS1)

SPECIFICATIONS

■ General specifications

Rated voltage	24 V DC	
Operating voltage range	90 to 110%V of rated voltage	
Inrush current	12 A or less	
Current consumption	200 mA or less	
Allowed momentary power off time	10 ms	
Fuse	Built-in type	
Terminal screw	M2	
Ambient temperature	0 to 55°C	
Storage temperature	-20 to +75°C	
Ambient humidity	30 to 85% RH (at 20°C, non-condensing)	
Breakdown voltage (initial)	500 V AC 1 minute	RS485 terminals ↔ Combined power supply and ground terminals
Insulation resistance (initial)	100 MΩ or higher (500 V DC using an insulation resistance meter)	
Vibration resistance	10 to 55 Hz, 1 cycle/min.: double amplitude of 0.75 mm, 1 hour on 3 axes	
Shock resistance	294 m/s ² or more, 5 times on 3 axes	
Dimensions	25 × 60 × 90	
Weight	Approx. 80 g	

■ Communication specifications Interface: Ethernet

Interface	IEEE802.3u, 10BASE-T/100BASE-TX	
Connector shape	RJ45	
Transmission specifications	Transmission speed	10 Mbps/100 Mbps
	Transmission method	Base band
	Max. segment length	100 m
Communication cable	Category 5 UTP cable	
Protocol	MODBUS TCP (RTU, ASCII), TCP/IP*8	
Functions	Auto negotiation function, MDI/MDI-X, Auto crossover function	

Ethernet is a registered trademark of Xerox Corporation.

■ Communication specifications Interface: RS232C and RS485

Interface	RS232C (non-insulated)	RS485 (insulated)
Conversion COM port*1	COM1	COM2
Communication style	1 : 1 communication	1 : N communication
Number of connectable stations	1 station	99 stations max.
Communication method	Full duplex	Half duplex
Synchronous method	Start-stop synchronization	—
Transmission distance	15 m	Max. 1200 m *2, 3
Communication speed	2400, 4800, 9600, 19200, 38400, 57600 and 115200bps	
Number of connectable connections*4	3	3
COM receive time out*5	Setting range: 10 ms to 300 s	Setting range: 10 ms to 300 s
Non-communication time before disconnection*6	Setting range: 0 to 1800 s (Not disconnected when set to "0".) *7	
Conversion and transmission format	Data length	8 bits fixed
	Parity	Odd/Even/None
	Stop bit	1 bit/2 bits
	End code	CR, CR+LF, None
Serial ↔ Ethernet conversion	Command/Response system	

Notes: 1. COM1 and COM2 can be used simultaneously.

2. When connecting a commercially available device, please confirm operation using the actual device. In some case, the number of stations, transmission distance, and communication speed vary depending on the connected device.

3. The values for the transmission distance, communication speed and number of stations should be within the values noted in the graph.

4. Number of TCP connections on the Ethernet side that can be connected to COM1 and COM2.

5. Length of time until the communication from the Ethernet side cuts off due to no response from each remote unit.

In case of 61s or more, time can be set in units of 1s.

6. Length of time until the signal converter side automatically ends the connection when the state of no communication from the Ethernet side with communication established exceeds the set time.

7. In case of setting "0: No disconnected", it cuts the connection automatically when no communication continues for two hours.

8. For transport layer protocol of Ethernet, MODBUS TCP (RTU, ASCII) can be selected in addition to TCP (from the main unit firmware V1.03 or higher).

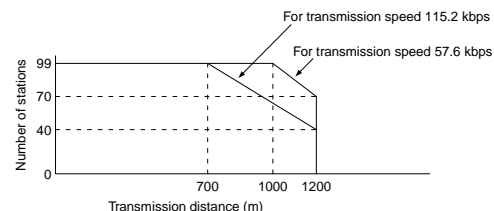

KS1 SIGNAL CONVERTER (AKS1)

PARTS NAMES AND DIMENSIONS (mm)

The CAD data of the products with a **CAD Data** mark can be downloaded from: <http://panasonic-electric-works.net/ac>

Tolerance: ±1.0

CAD Data

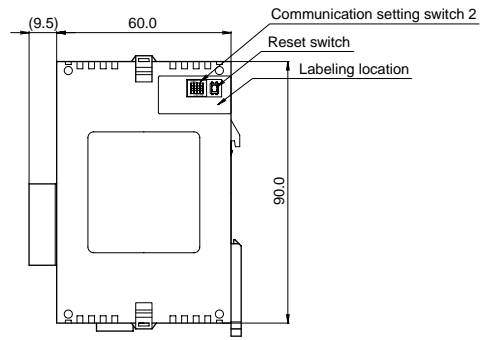
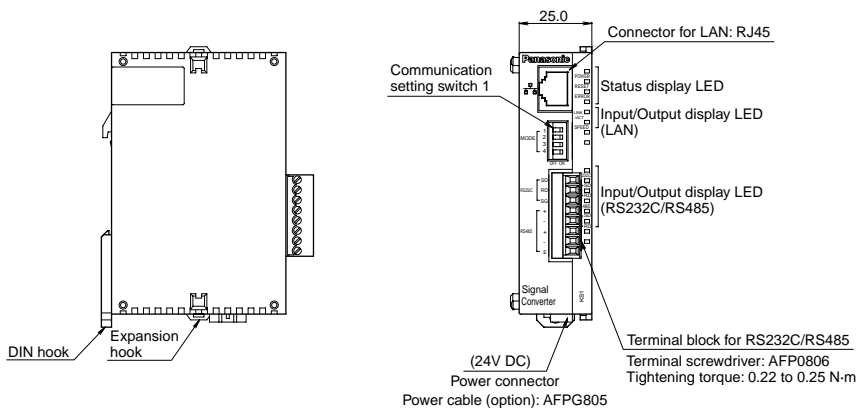

TERMINAL ARRANGEMENT

Be sure to wire correctly according to the terminal arrangement and wiring diagrams.

LAN Connector

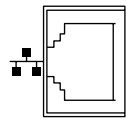

Connector: RJ45
Cable: UTP (Category 5 or more)

This unit recognizes automatically the cable, cross or straight.
Select cable according to the connected devices.

Power supply connector

Use the attached power supply cable (AFPG805) to connect power supply.

Mark	Attached power supply cable	
+	Brown	24V DC
-	Blue	0V
	Green	Function earth

- Notes:
- Please use twisted lines for power supply line (brown and blue) in order to reduce the noise effect from outside.
 - Please use a power supply of the insulation type with built-in protection circuit in order to protect against an abnormal voltage from power supply line.
 - Regulator on the unit is non-insulation type.
 - Use power supply voltage within the range of allowable voltage.

Rated voltage	24V DC
Operating voltage range	21.6 to 26.4V DC

RS232C/RS485 terminal block

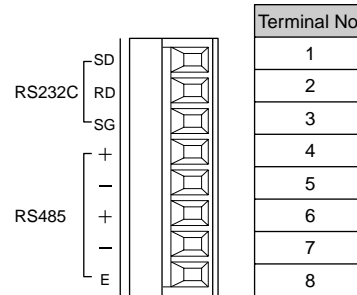

No.	Functions	
1	RS232C	SD
2	RS232C	RD
3	RS232C	SG
4	RS485	+
5	RS485	-
6	RS485	+
7	RS485	-
8	RS485	E

Terminal shape

Terminal name

COMMUNICATION SETTING

You can set communication conditions by two methods, using the communication set switches on the front of main unit and using the setting software (Configurator WD).

■ Set by the communication set switches

Use ④ Communication set switch 1 and ⑤ Communication set switch 2 to set communication setting.

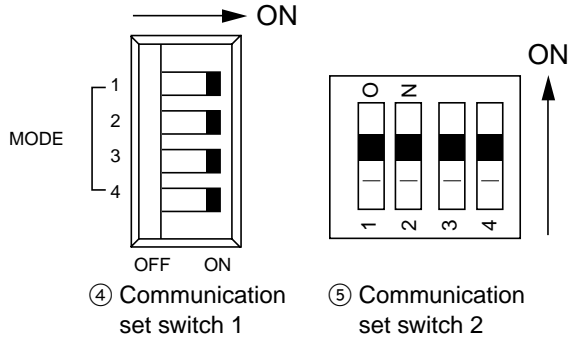

	MODE	Item	OFF	ON
④ Communication set switch 1	1	Transmission speed	Below table	
	2			
	3			
	4	Setting method	Software	Hardware *1
⑤ Communication set switch 2	1	Parity	Not available	Available
	2	Parity	Even number	Odd number
	3	Stop bit	2	1
	4	Vacant		

MODE 1	MODE 2	MODE 3	Transmission speed
OFF	OFF	OFF	115200bps
ON	OFF	OFF	2400bps
OFF	ON	OFF	4800bps
ON	ON	OFF	9600bps
OFF	OFF	ON	19200bps
ON	OFF	ON	38400bps
OFF	ON	ON	57600bps
ON	ON	ON	115200bps

- Notes:
1. Only when MODE 4 of ④ switch 1 is set to ON (Hardware), ④ and ⑤ switches' setting is available.
 2. When MODE 4 of ④ switch 1 is set to OFF (Software), ④ and ⑤ switches' setting is not available.
 3. Data length is fixed with 8 bit.
 4. Setting conditions are read when power turns on. You should set them before power turns on.
If you change the settings while power turns on, some malfunctions might be occurred.
 5. When setting by hardware (communication set switches), RS232C and RS485 communication settings are set as same. If individual setting for RS232C and RS485 is required, use the setting software.

■ Set by setting software Configurator WD

You can download the setting software "Configurator WD" from our website.
<http://panasonic-electric-works.net/ac>

Please refer to the help in Configurator WD for the way to set.

Note: In case of setting by "Configurator WD", MODE 4 of ④ switch 1 should be set to OFF (software).

CAUTIONS FOR SAFETY

Please use correctly only after you have thoroughly read "User's Manual, Instruction Manual, and Catalog".

KS1 SIGNAL CONVERTER (AKS1)

CAUTIONS BEFORE USING

■ Do not use the Unit in the following environments.

- Where the unit will be exposed to direct sunlight and where the ambient temperature is outside the range of 0 to 55°C.
- Where the ambient humidity is outside the range of 30 to 85% RH (at 20°C non-condensing) and where condensation might occur by sudden temperature changes
- Where inflammable or corrosive gas might be produced
- Where the unit will be exposed to excessive airborne dust or metal particles
- Where the unit will be exposed to water, oil or chemicals
- Where organic solvents such as benzene, paint thinner, alcohol, or strong alkaline solutions such as ammonia or caustic soda might adhere to the product
- Where direct vibration or shock might be transmitted to the product, and where water might wet the product
- Places unaffected by power transmission lines, high voltage equipment, power cables, power equipment, radio transmitters and any other equipment that would generate high switching surge.

■ Please use the Unit according to the specifications described in this manual. Otherwise, it may malfunction or cause fire and an electric shock.

- Connect to the power supply in compliance with the rating.
- Refer to the wiring diagram to ensure proper wiring for the power supply, input and output.
- Do not perform wiring or installation with a live line. It may also lead to circuit burnout or fire.
- Do not add voltage and current to an output terminal from outside.

■ Static electricity

- Discharge static electricity touching the grounded metal etc. when you touch the unit.
- Excessive static electricity might be generated especially in a dry place.

■ Cleaning

- Wipe dirt of the main unit with soft cloth etc. When thinner is used, the unit might deform or be discolored.

■ Power supply

- Connect a breaker to the voltage input part for safety reasons and to protect the device.
- Do not turn on the power supply or input until all wiring is completed.
- Do not add abnormal voltage directly, otherwise it might damage internal circuit.

■ Before power on

Please note the following points when turning on power at the first time.

- Confirm there are neither wiring rubbish nor especially an electrical conduction when installed.
- Confirm neither the power supply wiring, the I/O wiring nor the power-supply voltage are wrong.
- Tighten the installation screw and the terminal screw surely.
- Use an electric wire applicable to the rated current.

■ Others

- Please note that it might take time to approve the communication again after power on and breaking the communication.
- This product is designed to be used only with our options. Options from other companies are not compatible.