

USER'S GUIDE

K32A Series

Touch Screen LCD Monitors



TR Touch
Revolution

The information contained in this document is subject to change without notice.

This document contains proprietary information that is protected by copyright. All rights are reserved. No part of this document may be reproduced, translated to another language or stored in a retrieval system, or transmitted by any means, electronic, mechanical, photocopying, recording, or otherwise, without prior written permission. Windows is a registered trademark of Microsoft, Inc. Other brand or product names are trademarks of their respective holders.

The test results show that this device meets the FCC rules. Those limits are set to protect residential areas from the devices with harmful emission. This device will produce, use and radiate radio frequency energy. In addition, failure to follow the user's manual to install or use this device might produce harmful interference with radio communication. Notwithstanding the foregoing, it does not guarantee that this type of harmful interference does not occur in some special installations. The interference caused by this device to the reception of radio or television signals may be verified by turning it on and off. Any changes or modifications to this TFT LCD would void the user's authority to operate this device.

Important Recycle Instructions:

 LCD lamps inside this product may contain mercury. This product may contain other electronic waste that can be hazardous if not disposed of properly. Recycle or dispose in accordance with local, state, or federal Laws. For more information, contact the Electronic Industries Alliance at WWW.EIAE.ORG. For lamp specific disposal information check WWW.LAMPRECYCLE.ORG.

Table of Contents

Usage Notice

Precautions.....	1
------------------	---

Introduction

About K32A Series	2
Touch Screen for K32A Series	2
Package Overview	3

Installation

Product Overview	4
Front View	4
Bottom View	4
VESA Mount for Your Monitor	5
Connecting the Display (Figure 7.1).....	6
(Figure 7.1)	7

User Controls

Rear Panel Controls	8
How to Use the OSD Menus	9
On-Screen Display Menus	10

Appendix

Troubleshooting.....	11
Warning Signal	12
No Signal	12
Going to Sleep.....	12
Out of Range	12
Product Dimensions	13
Bezel Free	13
Compatibility Modes	14
Touch Screen Driver Installation	15
K32A Optional Calibration Tool Install	15

Usage Notice



Warning - To prevent the risk of fire or shock hazards, do not expose this product to rain or moisture.



Warning - Please do not open or disassemble the product as this may cause electric shock.

Precautions

Follow all warnings, precautions and maintenance as recommended in this user's manual to maximize the life of your unit.

Do:

- Turn off the product before cleaning.
- Touch screen surface may be cleaned using a soft clean cloth moistened with mild window glass commercial cleaners or 50/50 mixture of water and isopropyl alcohol.
- Use a soft cloth moistened with mild detergent to clean the display housing.

Don't:

- Do not touch the LCD Display screen surface with sharp or hard objects.
- Do not use abrasive cleaners.
- Do not operate the product under the following conditions:
 - Extremely hot, cold or humid environment.
 - Areas susceptible to excessive dust and dirt.
 - Near any appliance generating a strong magnetic field.
 - In direct sunlight.

Introduction

About K32A Series

The K32A Series is a 31.5" flat panel screen with an active matrix, thin-film transistor (TFT) liquid crystal display (LCD).

Features include:

- Direct Analog signal input
- Direct Digital signal input
- Active matrix TFT LCD technology
- 1920 x 1080 resolution
- 31.5" viewable display area - 16:9 aspect ratio
- 31.47 ~ 67.5 KHz horizontal scan
- 47 ~ 63 Hz high refresh rate
- 0.36375mm x 0.36375mm pixel pitch
- Auto adjustment function
- Multilingual OSD user control
- 400mm x 200mm VESA mount
- K32A Series - Projected Capacitive touch screen with USB controller
- Audio - 8W x 2

Touch Screen for K32A Series

- Project Capacitive touch screen for finger input only
- Surface: Clear glass
- Interface: USB controller
- HID Multi-Touch: Windows 7

Package Overview

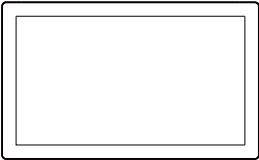

LCD Display

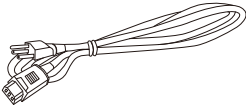

Power Cord

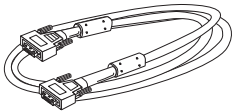

VGA Signal Cable



USB Cable (A to B)



Audio-in Cable

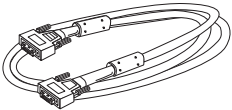

DVI-D Cable

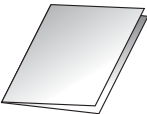

Quick Start Guide



Handle Screw Caps

Installation

Product Overview

- Front View

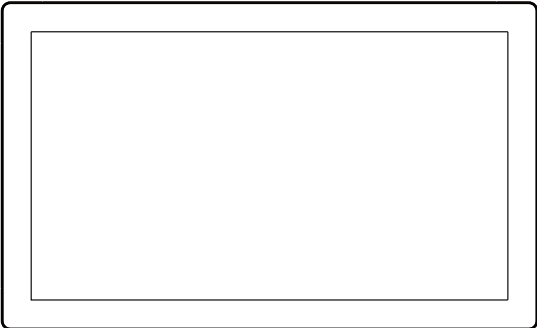

- Bottom View

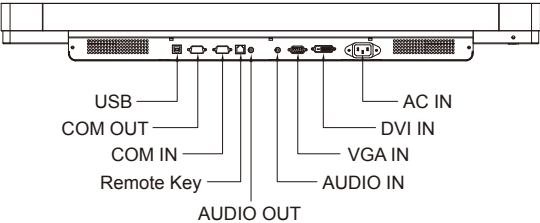

VESA Mount for Your Monitor

This monitor conforms to the VESA Flat Panel Mounting Physical Mounting Interface standard which defines a physical mounting interface for flat panel monitors, and corresponding with the standards of flat panel monitor mounting devices, such as wall and table arms. The VESA mounting interface is located on the back of your monitor.

To mount the monitor on a UL certified swing arm or other mounting fixture, follow the instructions included with the mounting fixture to be used.

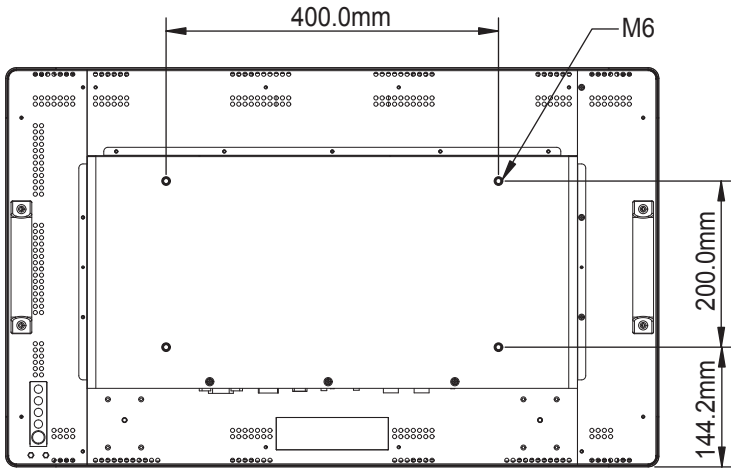

⚠ Warning!

Please select the proper screws!

The distance between the back cover surface and the bottom of the screw hole is 8 mm. Please use four M6 screws diameter with proper length to mount your monitor.

Please note: the mounting stand must be able to support at least 44.1 lbs (20Kg).

Connecting the Display (Figure 7.1)

To setup this display, please refer to the following figure and procedures.

1. Be sure all equipment is turned off.
2. Connect the AC power cord to the power connector on the monitor and the other end into an electrical outlet (7.1).
3. Connect the D-SUB or DVI cable from the display's VGA input connector to the D-SUB or DVI connector of your host computer and tighten the screws (7.1).
4. Connect the Audio-In cable from the audio input port of your display to the Audio-out port of your computer (7.1).
5. Connect the USB cable from USB port of your display to USB port of your computer (7.1).
6. Once the touch screen is configured, the monitor is ready for use.

Notice!

To ensure the LCD display works well with your computer, please configure the display mode of your graphics card to make it less than or equal to 1920 x 1080 resolution and make sure the timing of the display mode is compatible with the LCD display.

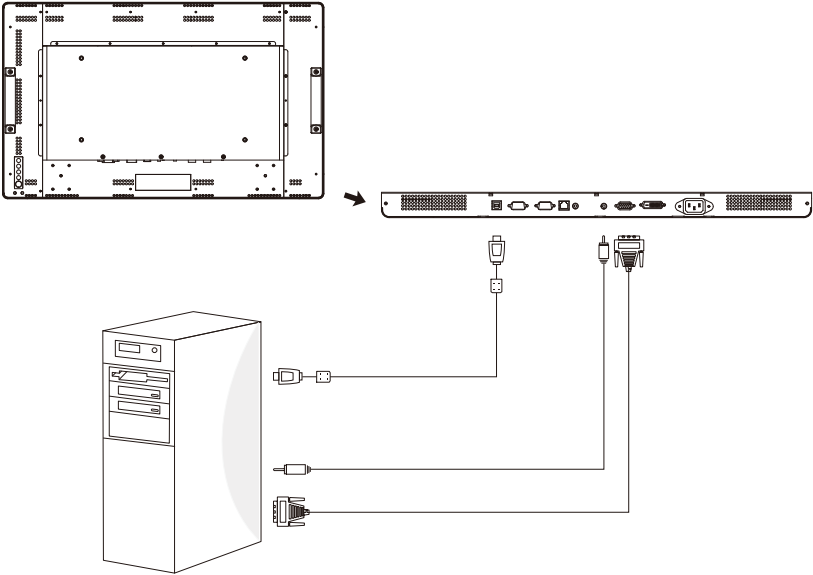

We have listed the compatible "Video Modes" of your LCD display in the appendix (on page 14) for your reference.

(Figure 7.1)



User Controls



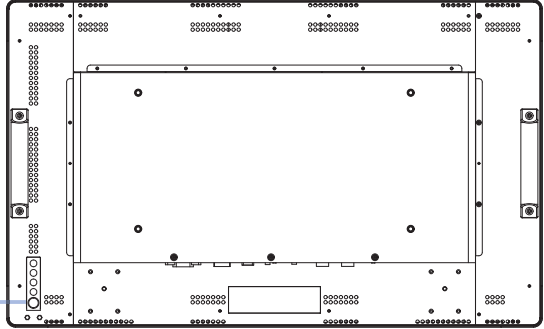

Rear Panel Controls

Icon	Key Name
	Menu
	Up
	Down
	Select
	Power



OSD Key	Menu off status	Menu on status
MENU	Menu appear	Menu disappear / return to main item
▲	Brightness	Main item select up / Adjust up
▼	Mute	Main item select down / Adjust down
SELECT	Auto Adjust	Select sub-item function
	Power On / Off	

How to Use the OSD Menu

Icon	Key Name
	Menu
	Up
	Down
	Select
	Power

1. Press the “MENU” button to pop up the “on-screen menu” and press “Up” or “Down” button to select among the six functions in the main menu.
2. Choose the adjustment items by pressing the “Select” button.
3. Adjust the value of the adjustment items by pressing the “Up” or “Down” button.
4. With the OSD menu on screen, press “ Menu” button to return main menu or exit OSD.
5. The OSD menu will automatically close, if you have left it idle for a pre-set time.
6. To Lock the OSD / Power menu buttons, please follow the instructions below.
(Please note: the monitor has to be turned ON with a valid signal pre-set)
 - (a.) Press “Menu” key , the OSD menu will pops upon display.
 - (b.) Press and hold the “Menu” key again with the OSD menu on the screen, the OSD menu will disappear. Then press the “Power” key 1 time while the menu key is still being pressed. The “Lock/Unlock” menu will appear for 3 seconds.
 - (c.) Use the “Select” key to select OSD or Power setting then set at “Lock” by pushing the “UP” or “Down” button.
 - (d.) When the “UP” or “Down” button is released, the previous setting will be saved and exit the “Lock/Unlock” menu automatically.
7. To Unlock the OSD / Power menu buttons, please follow the instructions below.
(Please note: the monitor has to be turned ON with a valid signal pre-set)
 - (a.) Press and hold the “Menu” key then press the “Power” key simultaneously, the “Lock/Unlock” menu will appear for 3 seconds.
 - (b.) Use the “Select” key to select OSD or Power setting then set at “Unlock” by pushing the “UP” or “Down” button.
 - (c.) When the “UP” or “Down” button is released, the previous setting will be saved and exit the “Lock/Unlock” menu automatically.

Please note:

- a. When the OSD Lock function is selected, this indicates that all the buttons except “power” button are now disabled.
- b. When the Power Lock function is selected, this indicates that the power key is disabled; user can not to turn off the monitor by “Power” key.

On-Screen Display Menus

Main OSD Menu:

ITEM	CONTENT
Contrast	The monitor luminance level control.
Brightness	The monitor backlight level control.
Auto Adjust	Fine-tune the image to full screen automatically.
Left/Right	Moving screen image horizontal position to left or right.
Up/Down	Moving screen image vertical position to up or down.
Horizontal size	The screen image horizontal dot clock adjustment.
Fine	The screen image pixel phase adjustment.
OSD Left/Right	Moving OSD menu horizontal position to left or right.
OSD Up/Down	Moving OSD menu vertical position to up or down.
OSD Time out	OSD auto-disappear time selection.
OSD Language	OSD menu language selection. (English, French, Japanese, Deutsch, Spanish, Italian, Traditional Chinese and Simplified Chinese)
Factory Reset	Factory default value restored.
RGB	Color temperature selection. (9300K, 6500K, 5500K, 7500K, User)
Volume	Audio volume adjustment.
Mute	Audio On/Off control.

Appendix

Troubleshooting

If you are experiencing trouble with the LCD display, refer to the following. If the problem persists, please contact your local dealer or our service center.

Problem: No image appears on screen.

- ▶ Check that all the I/O and power connectors are correctly and well connected as described in the “Installation” section.
- ▶ Make sure the pins of the connectors are not crooked or broken.

Problem: Partial image or incorrectly displayed image.

- ▶ Check to see if the resolution of your computer is higher than that of the LCD display.
- ▶ Reconfigure the resolution of your computer to make it less than or equal to 1920 x 1080.

Problem: Image has vertical flickering line bars.

- ▶ Use “Fine” to make an adjustment.
- ▶ Check and reconfigure the display mode of the vertical refresh rate of your graphic card to make it compatible with the LCD display.

Problem: Image is unstable and flickering

- ▶ Use “Fine” to make an adjustment.

Problem: Image is scrolling

- ▶ Check and make sure the VGA signal cable (or adapter) is securely connected.
- ▶ Check and reconfigure the display mode of the vertical refresh rate of your graphics card to make it compatible with the LCD display.

Problem: Vague image (characters and graphics)

- ▶ Use “Fine” to make an adjustment. If this problem still exists, use “Horizontal size” to make an adjustment.

Warning Signal

If you see warning messages on your LCD screen, this means that the LCD display cannot receive a clean signal from the computer graphics card.

Below are the three kinds of Warning Signal. Please check the cable connections or contact your local dealer or our service center for more information.

No Signal

This message means that the LCD display has been powered on but it cannot receive any signal from the computer graphics card. Check all the power switches, power cables, and VGA/DVI signal cable.

Going to Sleep

The LCD display is under the power saving mode. In addition, the LCD display will enter power saving mode when experiencing a sudden signal disconnecting problem.

The monitor can be activated by pressing any keyboard, triggering the mouse or touching the screen.

Out of Range

This message means that the signal of the computer graphic card is not compatible with the LCD display. When the signal is not included in the "Video Modes" list we have listed in the Appendices of this manual, the LCD monitor will display this message.

Product Dimensions

Bezel Free

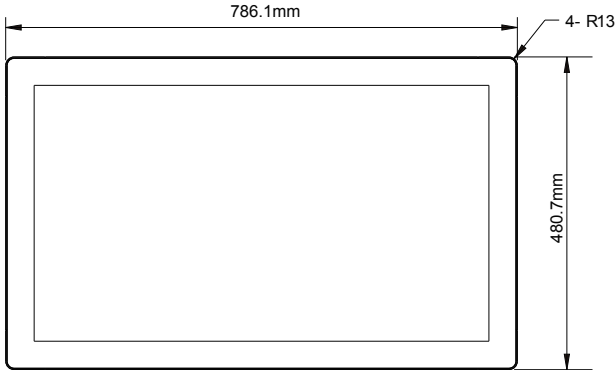

Front View

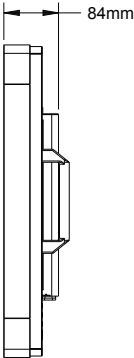

Side View

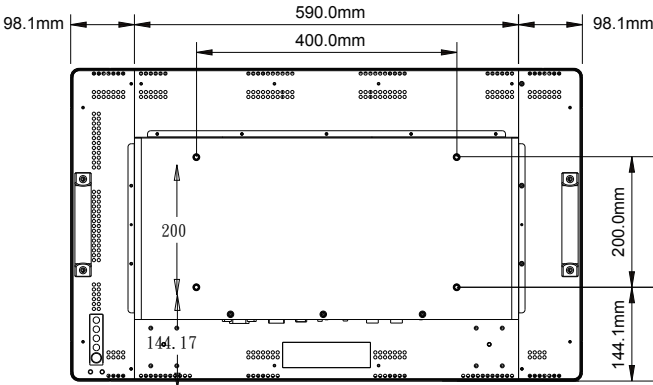

Back View

Compatibility Modes

Mode	Resolution	H-Frequency(khz)	V-Frequency(hz)
IBM VGA	640X480	31.47	60
VESA SVGA	800X600	35.16	56
VESA SVGA	800X600	37.88	60
VESA XGA	1024X768	48.36	60
VESA SXGA	1280X1024	64.00	60
VESA SXGA	1280X960	60.00	60
WXGA+	1440X900	56.00	60
WSXGA+	1680X1050	65.20	60
VESA WXGA	1280X768	47.776	60
VESA WXGA	1280X720	44.77	60
VESA WXGA	1366X768	47.71	60
WSXGA+	1920X1080	67.50	60

Touch Screen Driver Installation

The K32A Series is available with USB connection.

Please Note:

1. The K32A Series is Microsoft Windows® HID (Human Interface Device) compatible if you use the USB touch screen interface. No additional software driver is required for general operation of the touch screen.
2. This K32A Series touch display is compatible with Win 7 only.
3. When using K32A Series touch display for the first time or switching from monitor to PC. Please execute calibration tool, and do not touch the screen during executing calibration tool.
4. Microsoft Windows® 7 operating system requires 15 seconds to recognize the K32A Series after connecting the USB cable and power cable.

K32A Optional Calibration Tool Install:

If you would like to use the Optional Calibration Tool, follow the instructions.

1. Please go www.touchrev.com to download calibration tool.
2. Select size - 32"
3. Select model - K32A Series
4. Run or save calibration