

Analog Output Proportional to Light Received, Ideal For Inspection and Measurement

- Analog object detection ideal for position, size, color and surface characteristics
- Both analog and NPN transistor ON/OFF outputs available simultaneously
- Fast, 1 ms response time
- Selectable Light-ON/Dark-ON operation
- 4-turn sensitivity adjustment for precise control
- 2 m (6.56 ft) cable



## Ordering Information

### ■ SENSORS

Method of detection	Through-beam	Retroreflective	Diffuse reflective	Mark sensor
Sensing distance	2 m (6.56 ft), 30 cm (11.81 in) with E39-S1 slits	20 to 50 cm (7.87 to 19.68 in)	5 to 50 cm (1.97 to 19.68 in)	2 to 5 cm (0.79 to 1.97 in)
Part number	<b>E3SA-2C43A</b>	<b>E3SA-RS50C43A</b>	<b>E3SA-DS50C43A</b>	<b>E3SA-VS5RC43A</b>

### ■ ACCESSORIES

Description	Part number
Slits for E3SA-2C43A through-beam type help detect transparent and small objects (0.5, 1, 2 and 4 mm slits; mounting hardware)	<b>E39-S1</b>

### ■ REPLACEMENT PARTS

Description	Part number
Reflector (supplied with E3SA-RS50C43A retroreflective sensor)	<b>E39-R1</b>
Mounting bracket (supplied with each sensor)	<b>E39-L52</b>

# Specifications

Part number		E3SA-2C43A	E3SA-RS50C43A	E3SA-DS50C43A	E3SA-VS5RC43A
Method of detection		Through-beam	Retroreflective	Diffuse reflective	Mark sensor
Supply voltage		12 to 24 VDC			
Operating voltage		10.8 to 26.4 VDC; ripple 10% max. peak-to-peak			
Current consumption		Emitter: 60 mA max. Receiver: 20 mA max.	80 mA max.		
Sensing distance		2 m (6.56 ft) 30 cm (11.81 in) with E39-S1 slits	20 to 50 cm (7.87 to 19.68 in) with E39-R1 reflector (supplied)	5 to 50 cm (1.97 to 19.68 in) with 10 x 10 cm (3.94 x 3.94 in) white mat paper	2 to 5 cm (0.79 to 1.97 in) with 3 x 3 mm (0.12 x 0.12 in) black mark on white background
Light source (continuous)		Red LED 660 nm	Polarized infrared LED	Infrared LED 950 nm	Red LED 680 nm
Light source disable input (check input)		Provided Contact closure or high solid-state input shorts power to LED; 4 V max., 2.3 mA min. source current	Not provided	Not provided	Not provided
Detectable object type		Opaque materials	Opaque materials	Opaque and transparent materials	
Operation mode		Light-ON/Dark-ON, switch selectable			
Sensitivity		Adjustable; 4-turn potentiometer			
Operating point		Adjustable; 4-turn potentiometer			
Control output	Type	Analog	4 to 20 mA with 300 Ω max. load impedance; 2.45 to 4 mA minimum, 20 to 21.55 mA maximum 1 to 5 VDC using 250 Ω resistor supplied. See "Connections" for conversion.		
		On/Off	NPN, open collector; max., load 100 mA, 30 VDC		
Response time	On	1 ms max.			
	Off	1 ms max.			
Variation due to temperature fluctuations		±0.3% of full scale/°C			
Circuit protection	Output short-circuit	Provided			
	DC power supply reverse polarity	Provided			
Indicators		Emitter: Power On (red LED) Receiver: Light Incident (red LED) Output Operation (yellow LED)	Light Incident (red LED) Output Operation (yellow LED)		
Materials	Lens	Plastic			
	Case	Plastic			
	Cable sheath	Plastic			
Mounting		Side surface mount with two through holes. E39-L52 bracket and mounting hardware supplied.			
Connections	Prewired	Emitter: 2-conductor cable, 2 m (6.56 ft) length Receiver: 5-conductor cable, 2 m (6.56 ft) length	4-conductor cable, 2 m (6.56 ft) length		
Weight		Emitter: 140 g (5 oz) Receiver: 140 g (5 oz)	140 g (5 oz)		
Enclosure	IEC 144	IP66			
Ambient temperature	Operating	-10°C to 55°C (14°F to 131°F)			
	Storage	-30°C to 70°C (-22°F to 159°F)			

■ OUTPUT CIRCUIT DIAGRAM

Through-Beam Type E3SA-2C43A

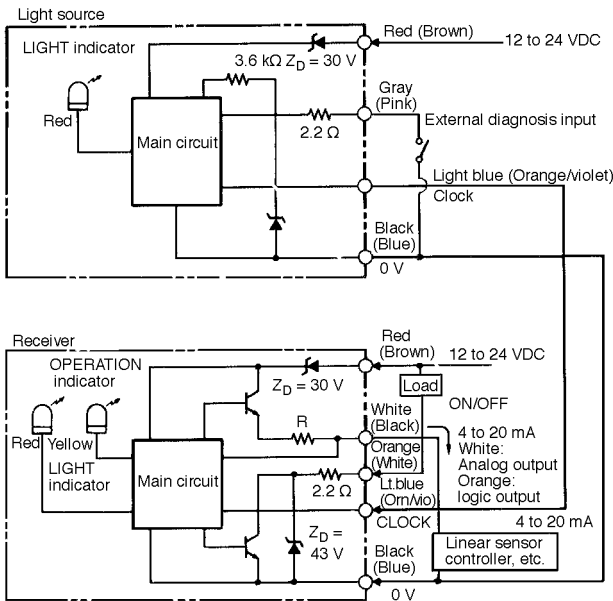

Polarized Retroreflective Type E3SA-RS50C43A  
 Diffuse Reflective Type E3SA-DS50C43A  
 Mark Sensor E3SA-VS5RC43A  
 Fiber-Optic Amplifier E3XA-CC4A

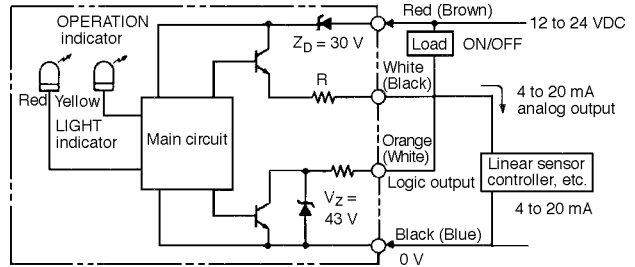

Note: IEC colors are shown in parentheses.

■ TIMING CHARTS

Through-Beam Type E3SA-2C43A

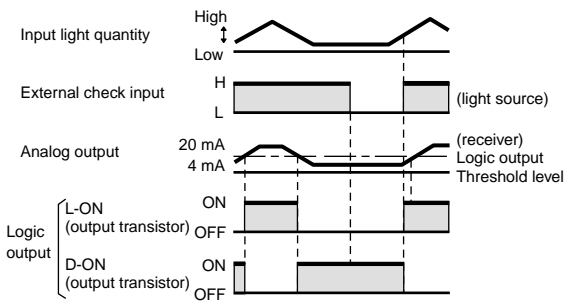

Note: The light source operates (ON) when the external check input is open; it does not operate (OFF) when the external check input is ON (Low).

Polarized Retroreflective Type E3SA-RS50C43A  
 Diffuse Reflective Type E3SA-DS50C43A  
 Mark Sensor E3SA-VS5RC43A  
 Fiber-Optic Amplifier E3XA-CC4A

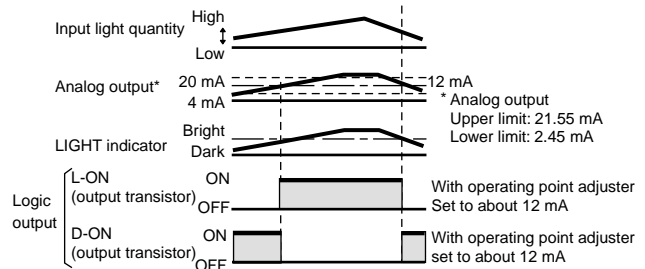

# Connections

## Through-Beam Type E3SA-2C43A

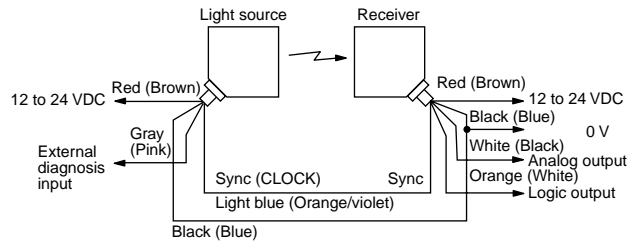

## Polarized Retroreflective Type E3SA-RS50C43A Diffuse Reflective Type E3SA-DS50C43A Mark Sensor E3SA-VS5RC43A

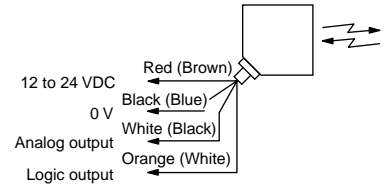

Note: IEC colors are shown in parentheses.

### For voltage output (1 to 5 VDC)

To convert current output into voltage output (1 to 5 VDC), use the 250-ohm resistor, supplied with the sensor.

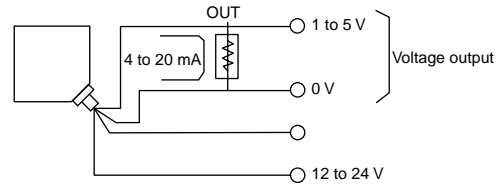

# Engineering Data

## OPERATING RANGE

### Through-Beam Type E3SA-2C43A without slit

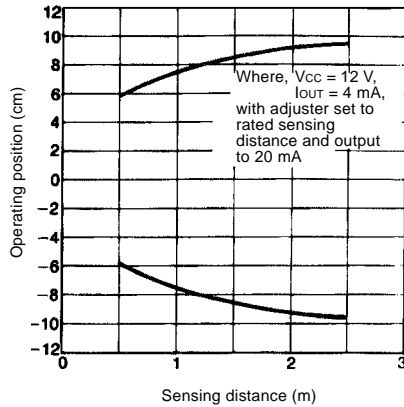

### Polarized Retroreflective Type E3SA-RS50C43A

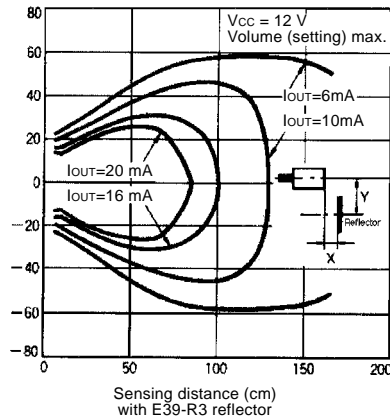

### Diffuse Reflective Type E3SA-DS50C43A

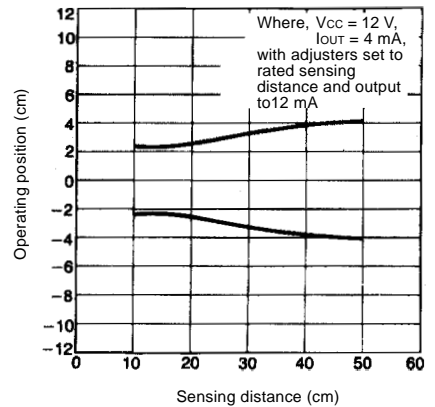

■ DISTANCE vs. ANALOG OUTPUT CURRENT

Through-Beam Type  
E3SA-2C43A without slit

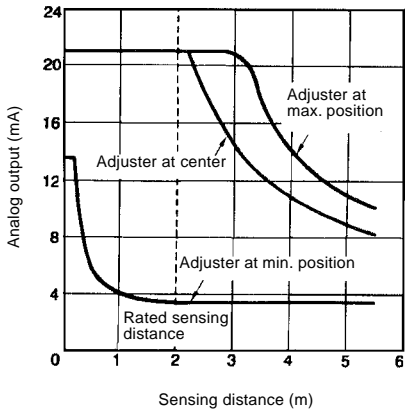

Through-Beam Type  
E3SA-2C43A with slit

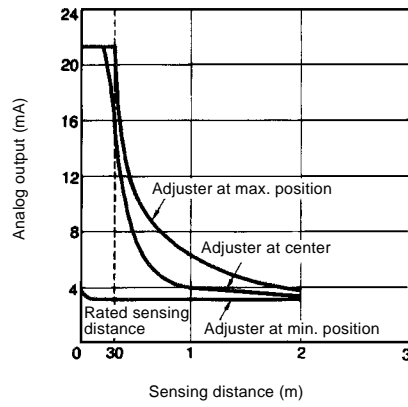

Polarized Retroreflective Type  
E3SA-RS50C43A

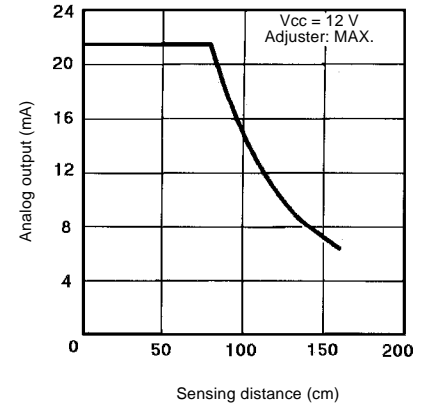

Diffuse Reflective Type  
E3SA-DS50C43A (white object)

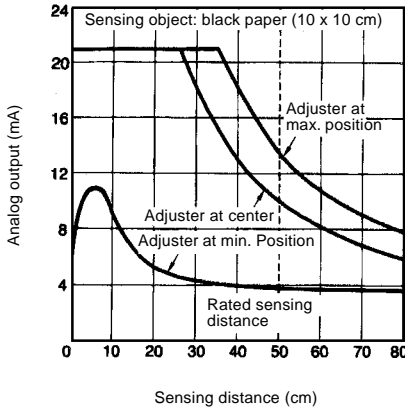

Diffuse Reflective Type  
E3SA-DS50C43A (black object)

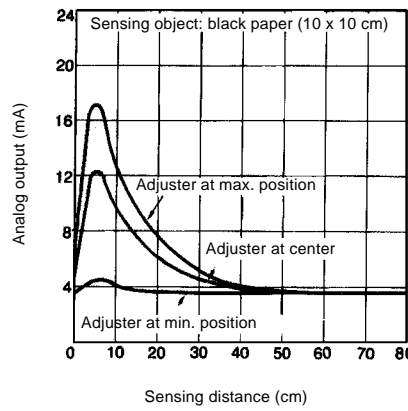

Mark Sensor Type E3SA-VSRC43A

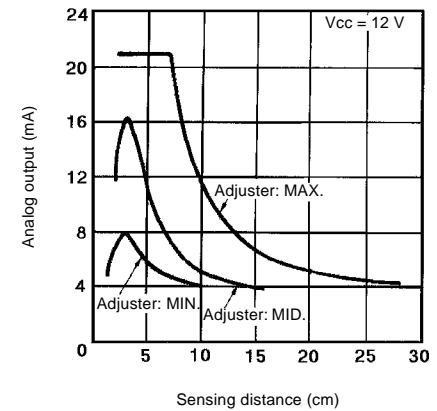

■ OBJECT SIZE vs. OUTPUT

Diffuse Reflective Type  
E3SA-DS50C43A

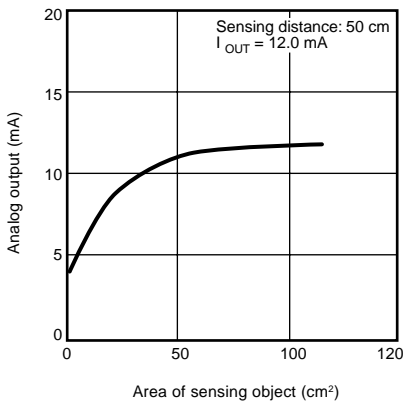

Diffuse Reflective Type  
E3SA-DS50C43A

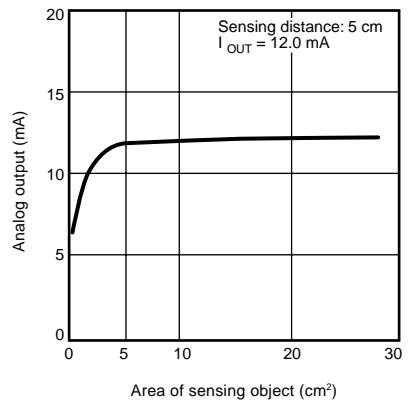

Mark Sensor Type E3SA-VSRC43A

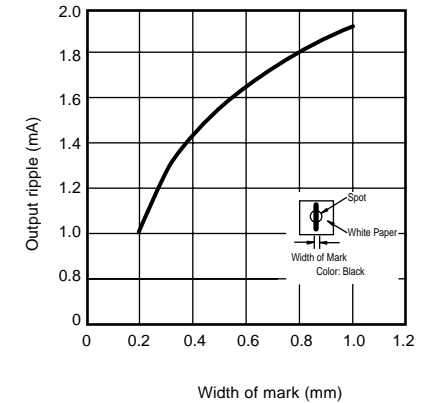

**Polarized Retroreflective Type  
E3SA-RS50C43A**

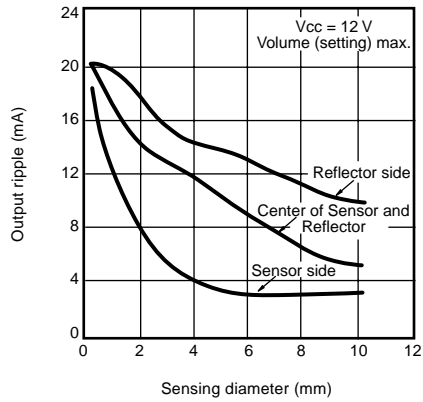

■ LIGHT INTERRUPTING CHARACTERISTICS

**Through-Beam Type E3SA-2C43A  
Without Slit, in Y Direction**

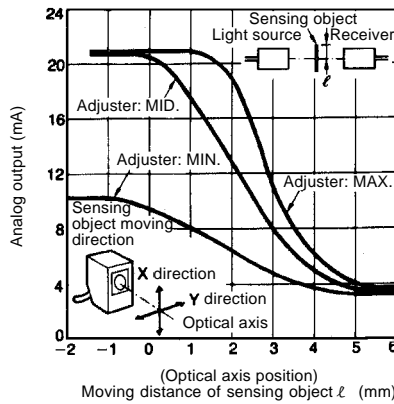

**Through-Beam Type E3SA-2C43A  
Without Slit, in X Direction**

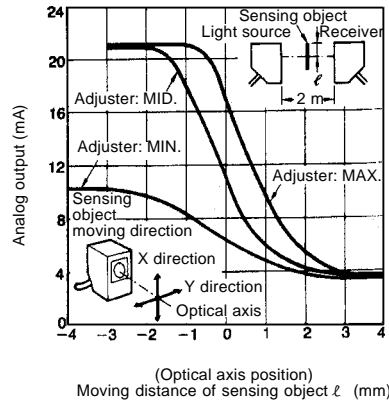

**Through-Beam Type E3SA-2C43A  
With Slit, in Y Direction**

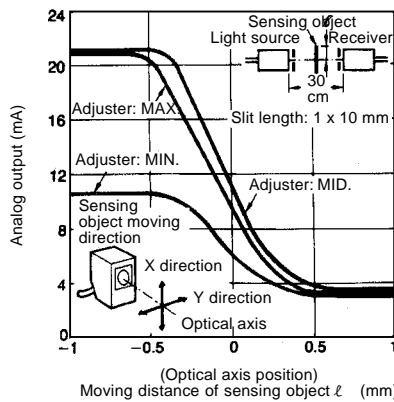

**Through-Beam Type E3SA-2C43A  
With Slit, in X Direction**

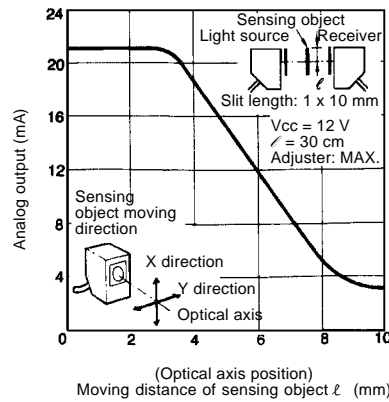

**MUTUAL INTERFERENCE**

If sensors are installed side by side, provide at least the minimum distance shown in the shaded region of the following charts between sets of fibers to prevent mutual interference.

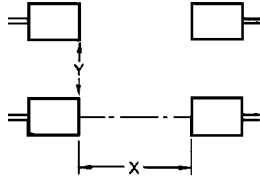

**Through-Beam Type  
E3SA-2C43A Without Slit**

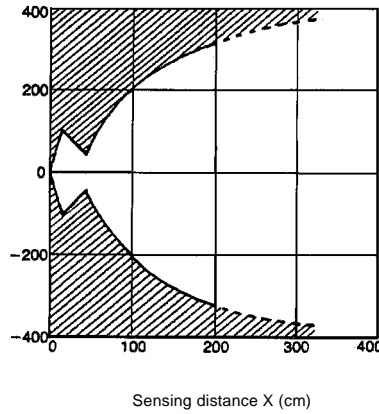

**Through-Beam Type  
E3SA-2C43A With Slit**

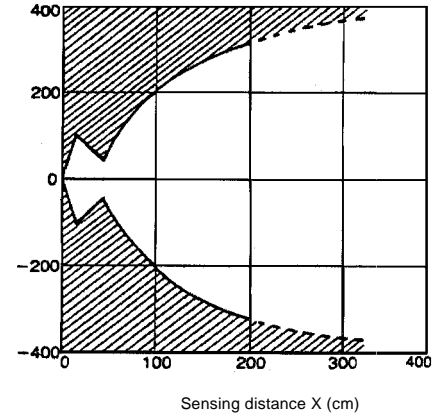

**INFLUENCE OF EXTERNAL LIGHT INTERFERENCE**

**Through-Beam Type  
E3SA-2C43A Without Slit**

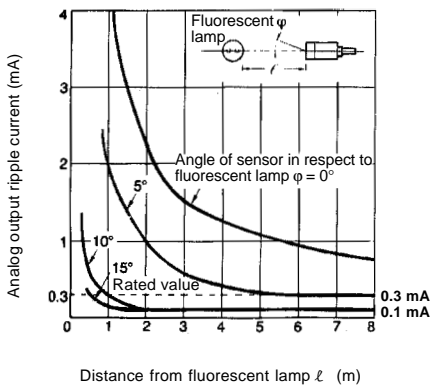

**Through-Beam Type  
E3SA-2C43A With Slit**

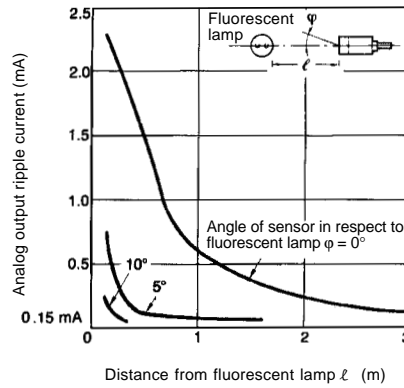

**Retroreflective Type  
E3SA-RS50C43A**

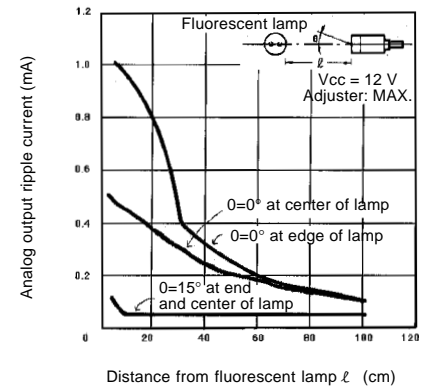

**Diffuse Reflective Type  
E3SA-DS50C43A**

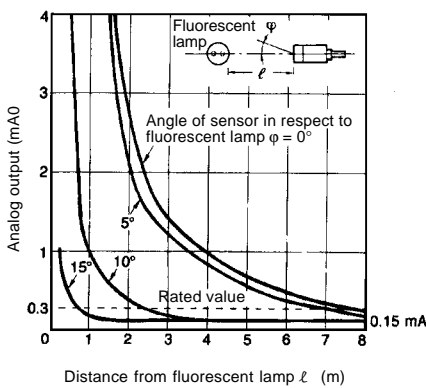

**Diffuse Reflective Type  
E3SA-VS5RC43A**

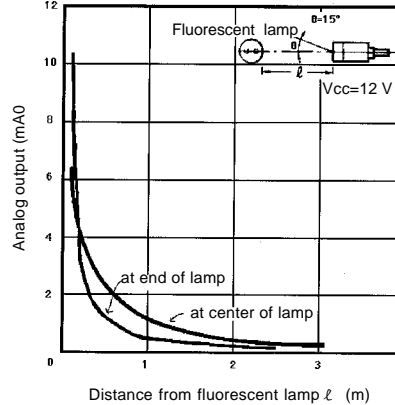

■ TRANSPARENCY AND COLOR vs. ANALOG OUTPUT

Through-Beam Type E3SA-2C43A  
Without Slit

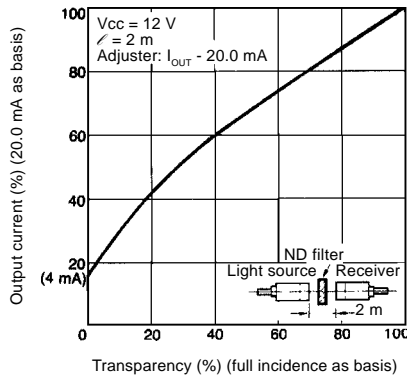

■ COLOR MARK DETECTION CAPABILITY

Mark Sensor Type E3SA-VS5RC43A

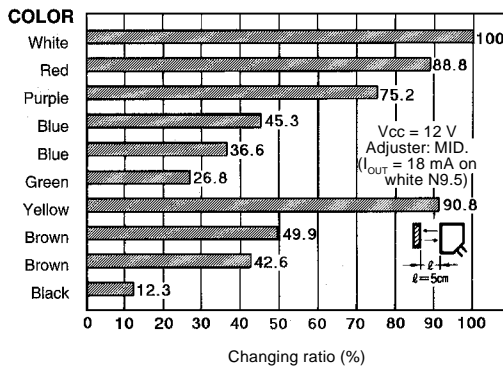

Diffuse Reflective Type E3SA-DS5C43A

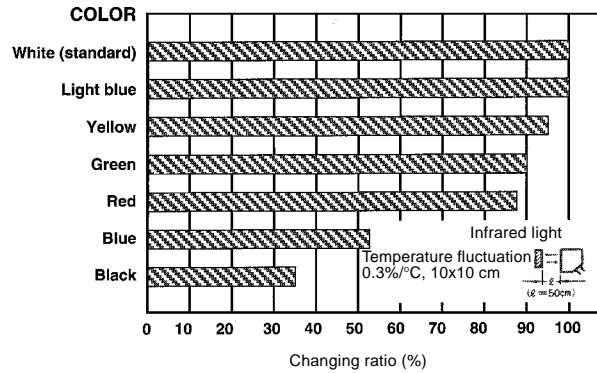

Dimensions

Unit: mm (inch)

Through-Beam Type E3SA-2C43A

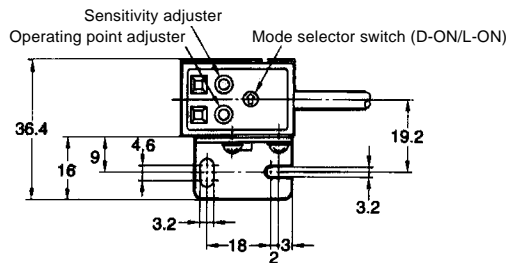
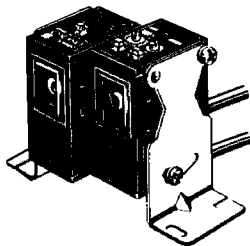

Mounting holes

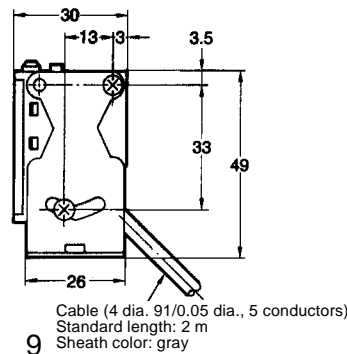
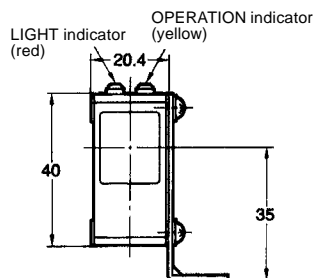
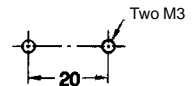



Retroreflective Type E3SA-RS50C43A (included E39-R1 reflector)

Diffuse Reflective Type E3SA-DS50C43A

Mark Sensor E3SA-VS5RC43A

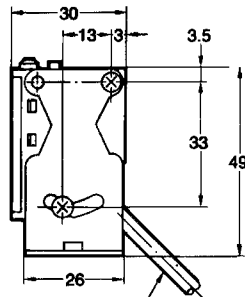
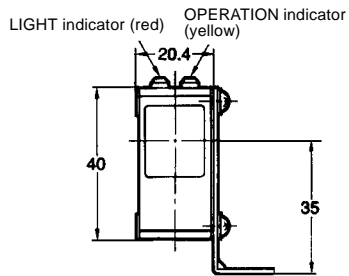
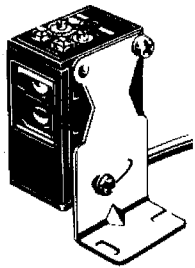

Cable (3.8 dia. 91/0.05 dia., 4 conductors)  
Standard length: 2 m  
Sheath color: gray

**Mounting holes**

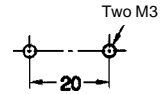

■ REFLECTORS

E39-R1 Reflector supplied with each E3SA-RS50C43A Retroreflective Sensor

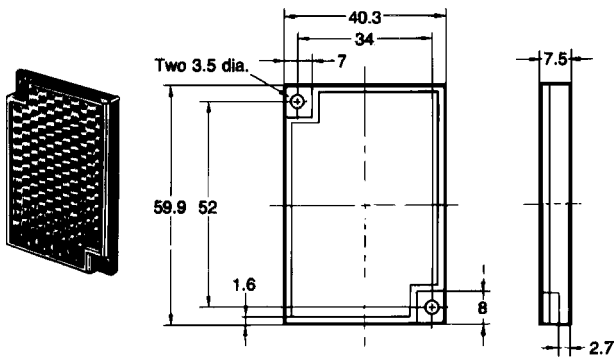

Operation

■ NOMENCLATURE

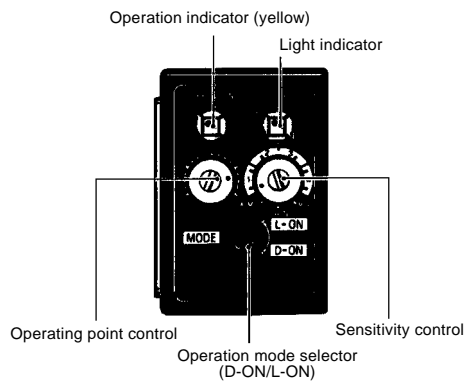

## ■ ADJUSTMENTS

### For Through-Beam and Retroreflective Sensors

#### Using Indication:

Mount the emitter or reflector, then loosely mount the receiver. Aim the receiver to get the maximum brightness on the Light Indicator. Adjust the Sensitivity Control (gain) to maximize the brightness. Then securely mount the receiver to maintain the position.

#### Using Analog Output:

Use an ammeter to measure the milliamp current output from the sensor. Mount the emitter or reflector, then loosely mount the

receiver. Aim the receiver to get the maximum analog output (20 mA). Move the receiver up and down, left to right to determine the area that produces maximum output. Aim the receiver in the center of that area then securely mount the receiver to maintain the position. Adjust the gain using the Sensitivity Control to produce 20 mA or the desired maximum current output.

To ensure proper adjustment for best sensitivity, be certain that the current has not become saturated above the 20 mA

maximum limit. This makes normal detection impossible because the deviation of output at saturation becomes too small for differentiation.

#### The Easy Method:

The simple way is to use the Operation Point control. Set the operating point at 20 mA (fully clockwise), then search for the position that turns on the Operation Indicator.

### For Diffuse Reflective Sensors

#### Using Indication:

Securely mount the diffuse reflective or mark detecting sensor, or diffuse reflective fiber-optic sensing head. Place the object to be detected at the position where detection should occur. Adjust the Sensitivity Control (gain) to the point where the Operation Indicator lights. Then fine-tune the gain to maximize the brightness of the Light Indicator.

#### Using Analog Output:

Securely mount the diffuse reflective or mark detecting sensor, or diffuse reflective fiber-optic sensing head. Use an ammeter to measure the milliamp output from the sensor or E3XA amplifier. Place the object to be detected at the position where detection should occur. Adjust the gain using the Sensitivity Control to produce

20 mA or the desired maximum current output.

To ensure proper adjustment for best sensitivity, be certain that the current has not become saturated above the 20 mA maximum limit. This makes normal detection impossible because the deviation of output at saturation becomes too small for differentiation.

## ■ INFLUENCE OF FLUORESCENT LIGHTING

Do not allow direct exposure of fluorescent light on the receiver (through-beam types) or emitter/receiver (reflective types). This may have adverse affects on the analog output current.

When mounting the sensor, keep the angle formed between the light of the fluorescent lamp and the optical axis of the sensor at more than 15 degrees.

#### CORRECT

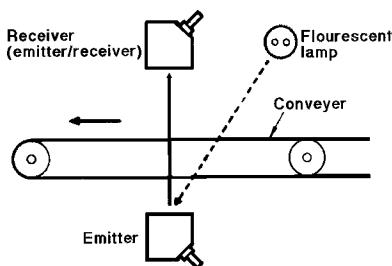

#### INCORRECT

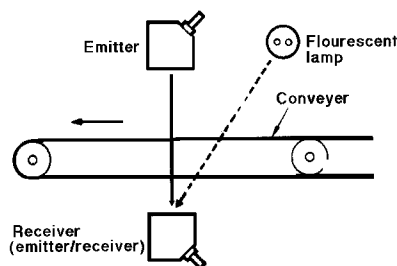

## ■ AMPLIFIER OUTPUTS

#### Analog Output

Set the analog output by allowing a hysteresis of more than 2% full scale (about 0.3 mA), also taking into account the effects of external fluctuations. This effect is already taken into account when using S3A-D and S3A2 analog sensor controllers.

#### Logic (On/Off) Output

The differential for the discrete On/Off logic output is set at about 2 mA. Output short-circuit protection is provided.



**OMRON ELECTRONICS LLC**

One East Commerce Drive  
Schaumburg, IL 60173

**1-800-55-OMRON**

Cat. No. CEDSAX4

11/01

**OMRON ON-LINE**

Global - <http://www.omron.com>  
USA - <http://www.omron.com/oei>  
Canada - <http://www.omron.com/oci>

Specifications subject to change without notice.

**OMRON CANADA, INC.**

885 Milner Avenue  
Scarborough, Ontario M1B 5V8

**416-286-6465**

Printed in the U.S.A.