

PSM-FO-Powermeter

FO measuring instrument

Contents

1. Short Description

2. Scope of delivery

3. Functional description

- 3.1. Choice of FO adapter
- 3.2. Switching on the measuring instrument
- 3.3. Displaying measured value
- 3.4. Setting the wavelength
- 3.5. Choosing the method of measuring
- 3.6. Saving a measured value

4. Measuring technique

- 4.1. Determining the optical power reserve of a transmission path
- 4.2. Measuring the transmission capacity
- 4.3. Determining cable attenuation based on DIN EN 186 000, method 7
- 4.4. Determining the attenuation per kilometer of FO fiber

5. Sample applications for INTERBUS

- 5.1. Determining the incoming emissivity in an INTERBUS system
- 5.2. Measuring the transmission capacity of INTERBUS devices

6. The basics of FO measurement technology

- 6.1. Method of measurement
- 6.2. Effects of ageing
- 6.3. The effects of temperature
- 6.4. Overview of the various FO types

7. Technical data

- 7.1. Measuring instrument
- 7.2. Adapter fibers
- 7.3. Calibration service



Fig. 1

1. Short Description

The optic fiber portable power meter

The PSM-FO-Powermeter optic fiber portable power meter is used to carry out optical capacity measurements. Path attenuations and the remaining system reserve in FO transmission systems are thus simple to determine.

The case contains an active-power meter and all the necessary instrument leads and adapters for checking polymer, HCS and glass fiber paths having an F-SMA or B-FOC connection.

PSM-FO-Powermeter

FO measuring instrument

2. Scope of delivery

PSM-FO-Powermeter

FO measuring instrument

- ① OPM 4 measuring instrument with 9 V battery
- ② F-SMA adapter
- ③ B-FOC (ST[®]) adapter
- ④ 50/125µm glass fiber with B-FOC (ST[®]) connector
Desig.: FO 50/125 ST
- ⑤ 50/125µm glass fiber with F-SMA connector
Desig.: FO 50/125 FSMA
- ⑥ 200/230µm HCS fiber with F-SMA connector
Desig.: HCS 200/230 FSMA
- ⑦ 980/1000µm polymer fiber with F-SMA connector
Desig.: POF 980/1000 FSMA
- ⑧ F-SMA coupler
- ⑨ B-FOC coupler
- ⑩ Operating instructions
- ⑪ Hard case

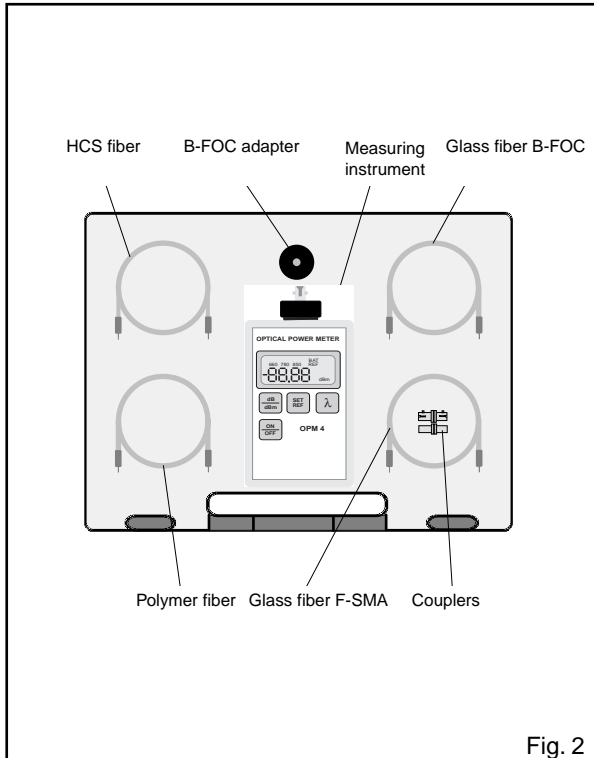

Fig. 2

3. Functional description

Keep all the optical connections free of grease and dust. Apart from these impurities, scratches on the surface of the plug connectors can also impair the accuracy of the measurement. Please replace the protective caps after use and clean all optical surfaces with a soft cloth if necessary.

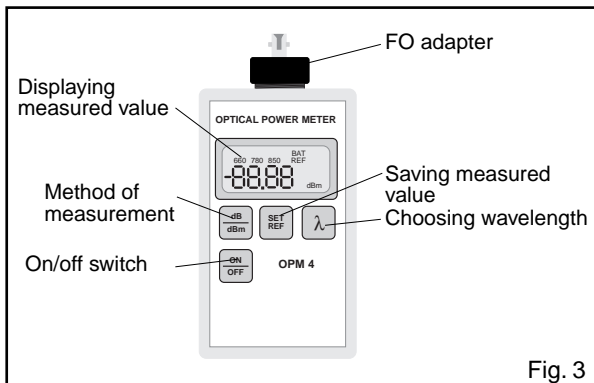

Fig. 3

3.1. Choice of FO adapter

Adapters for F-SMA and B-FOC plug connectors are included in the scope of delivery of the measuring instrument. In the standard version, the F-SMA adapter is screwed on. To make measurements on B-FOC plug connectors, screw on the enclosed adapter.

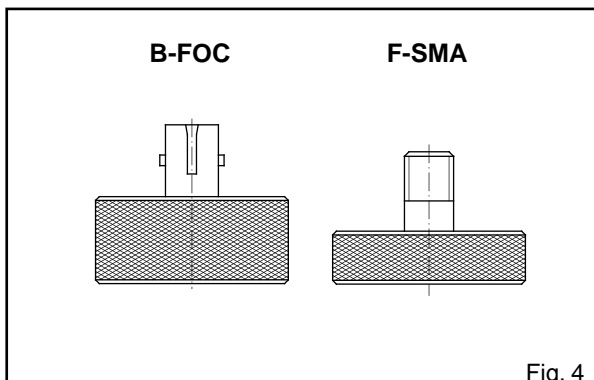

Fig. 4

ST[®] is a registered trademark of AT & T

PSM-FO-Powermeter

FO measuring instrument

3.2. Switching on the measuring instrument

Press the **ON/OFF** button to turn the PSM-POWERMETER on or off.

In order to extend the life of the battery, the device has an automatic switch-off function that switches it off five minutes after the button has been pressed. This automatic function can be deactivated when the device is switched on by pressing the **ON/OFF** button until ' . P ' appears on the display (approx. 3 s).

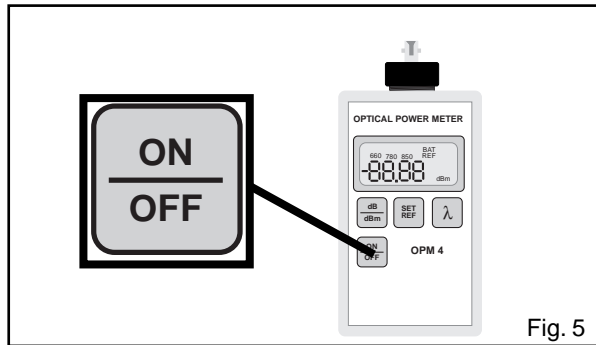

Fig. 5

3.3. Measured value display

The following are shown on the display:

- measured value in dBm/dB
- wavelength set in nm
- overshooting or undershooting of measuring range (HI/LO)
- for attenuation measurement: REF
- for too low a battery voltage: BAT

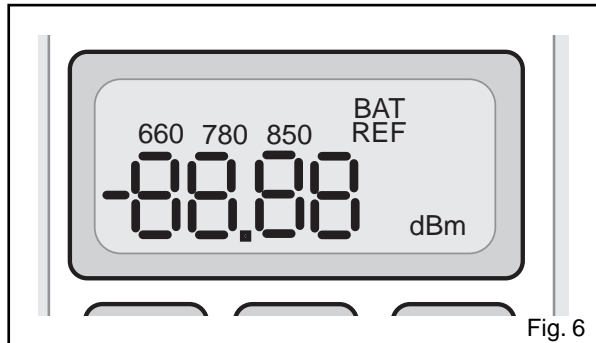

Fig. 6

3.4. Setting the wavelength

You can select the wavelength range to be measured with the λ button. By briefly pressing the λ button, the next wavelength range is selected in the order of 660 nm - 780 nm - 850 nm.

The wavelength of a transmitter can be found in the technical data of the device.

Measurements made with the wrong wavelength set result in incorrect measured values.

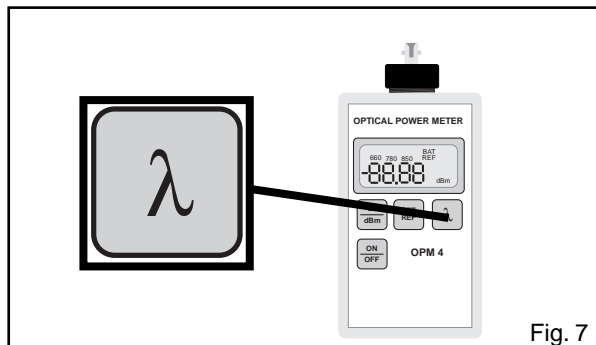

Fig. 7

3.5. Choosing the method of measuring

By pressing this button briefly, you switch between power measurement (display **dBm**) and attenuation measurement (display **dB** and **REF**).

Explanations on these methods of measuring can be found in chapter 5.

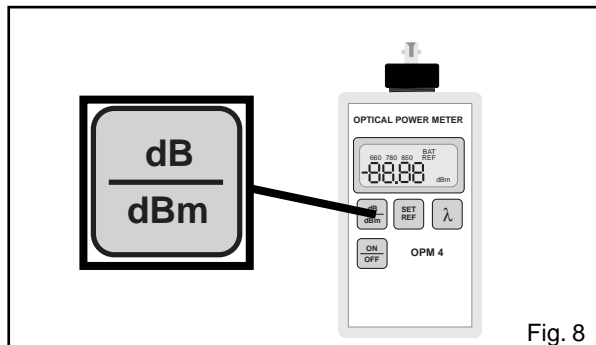

Fig. 8

3.6. Saving a measured value

Keep the **SET REF** button pressed until **HOLD** appears on the display (approx. 3 s), to save the current measured value. It then also switches over automatically to attenuation measurement.

By briefly pressing the **SET REF** button, the saved measured value is displayed for approx. 3 seconds.

The saved value is not lost even after the device has been switched off.

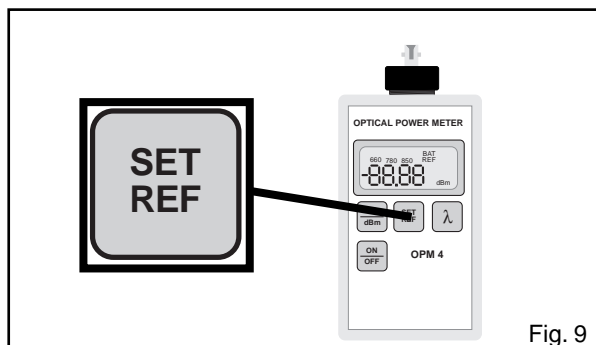

Fig. 9

PSM-FO-Powermeter

FO measuring instrument

4. Measuring technique

4.1. Determining the optical power reserve of a transmission path

Target:

To measure the optical power reserve of the transmission path at start-up or in the event of a fault. Since a transmission path generally consists of two FO fibers, the power reserve must be determined for both fibers. The power reserve is the difference between the incoming emissivity at the receiver and the receiver sensitivity of the device. The receiver sensitivity can be found in the technical data of the device. The power reserve should be at least +3 dB in glass fiber installations and at least +4.5 dB when HCS fiber or polymer fiber is used ²⁾.

Procedure:

1. Connect the transmitter so that **continuous light** is emitted. Information on this can be found in the operating instructions of the device.
2. Set the measuring instrument to the correct wavelength range and select the suitable FO-adapter (ST[®] or F-SMA)
3. Select **dBm** for power measurement
4. Connect the incoming fiber to the measuring instrument
5. The optical transmission capacity at the end of the path appears on the display in **dBm**
6. Now calculate the difference between receiver sensitivity and measured transmission capacity
7. Repeat steps 4 and 5 for the second fiber. The smaller value determines the optical power reserve of the transmission path.

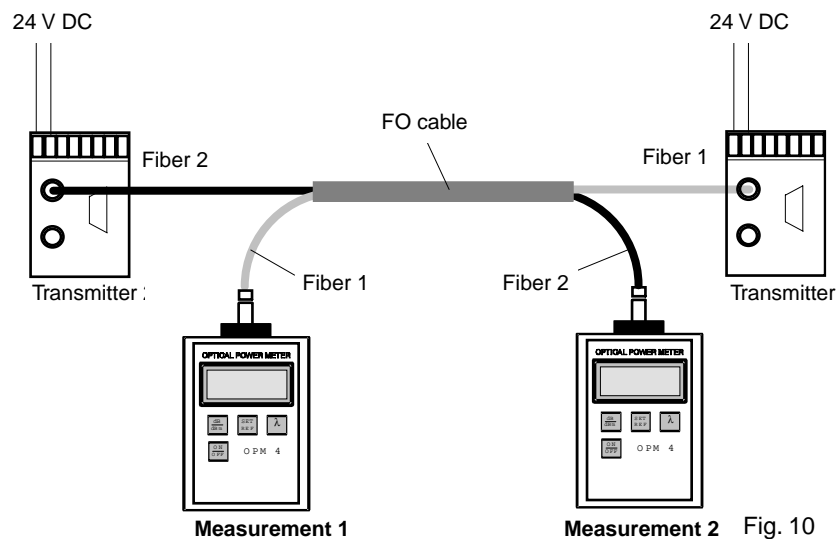

2) This value applies for new devices and measurements with an ambient temperature of 25 °C. For minimum values for existing systems and higher ambient temperatures, see 6.2. Effects of ageing, and 6.3. The effects of temperature (see also installation guideline).

PSM-FO-Powermeter

FO measuring instrument

4.2. Measuring the transmission capacity

Target:

To check whether the minimum specified transmission capacity is being emitted by measuring the optical transmission capacity. Information on this can be found in the technical data of the device³⁾.

Procedure:

1. Connect the transmitter so that **continuous light** is emitted. Instructions can be found in the operating instructions of the device
2. Taking into consideration the type of connector and fiber dimensions⁴⁾, choose the reference fiber to match the device
3. Set the correct wavelength range. The wavelength of the device can be found in the technical data of the device
4. Select **dBm** for power measurement
5. The transmission capacity of the module appears on the display in **dBm**
6. To evaluate the measured value, compare the transmission capacity displayed with the technical data³⁾

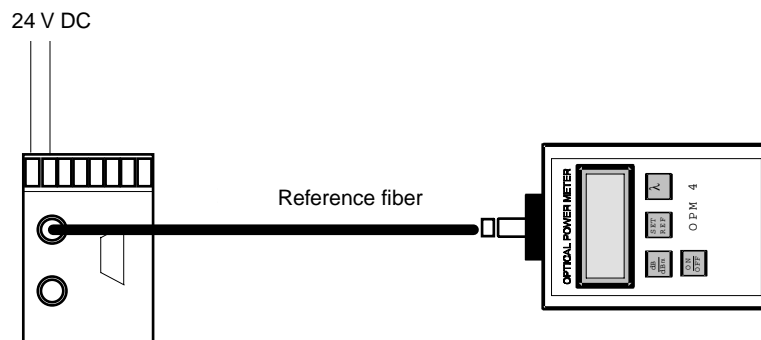

Fig. 11

³⁾ This value applies for new devices and measurements with an ambient temperature of 25 °C. For minimum values for existing systems and higher ambient temperatures, see 6.2. Effects of ageing, and 6.3. The effects of temperature.

⁴⁾ A cross-reference table for wavelength, fiber type and connector type can be found under 6.4. Overview of the ...

PSM-FO-Powermeter

FO measuring instrument

4.3. Determining cable attenuation based on DIN EN 186 000, method 7

Target:

Checking the attenuation of a reference fiber

Concept:

Using method 7, the specific attenuation of the enclosed reference fibers, for example, can be checked. With this method, the complete attenuation of a cable fitted with connectors is measured. A measuring method by which the pure fiber attenuation (without connector) is determined can be found under 4.4.

Procedure:

1. Select a suitable transmitter by wavelength and type of connector⁴⁾
2. Connect the transmitter so that continuous light is emitted
3. Measure the transmission capacity as in 4.2., Measuring the transmission capacity
4. Save the measured value by keeping the **SET REF** button pressed for some time (approx. 3 seconds)
5. With the aid of the enclosed coupler, connect the cable to be measured to the measuring cable.
6. The value displayed is the cable attenuation in **dB**
7. Turn the cable to be measured round and repeat steps 5 and 6.
8. When checking a reference fiber, both values must be within the given tolerance.
(see Technical data, 7.2.)

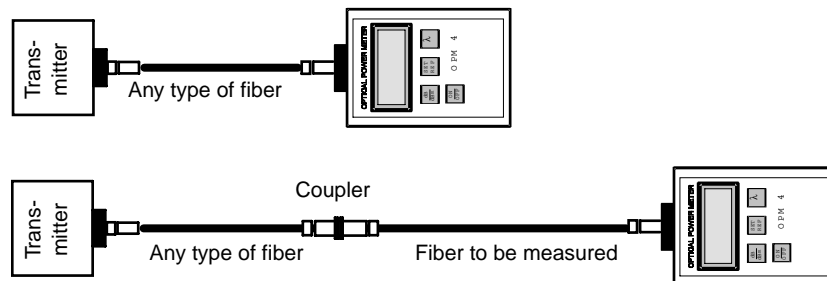

Fig. 12

⁴⁾ A cross-reference table for wavelength, fiber type and connector type can be found under 6.4. Overview of the ...

PSM-FO-Powermeter

FO measuring instrument

4.4. Determining the attenuation per kilometer of FO fiber

Target:

To check the quality of the fiber by means of comparative measurement. This method is only suited for HCS and glass fibers; the kilometric attenuation of polymer fibers also depends on the length of the cable to be measured.

Concept:

The comparison measurement is a method of determining the typical kilometric fiber attenuation by approximation. The attenuation of an existing fiber is compared with a 1m long reference fiber. The reference fiber must have the same fiber diameter as the fiber to be measured.

The accuracy of the comparative measurement depends largely on how the connector is assembled. Since assembly is subject to wide tolerances, determining the typical fiber attenuation is not to be recommended below the following lengths:

Glass fiber:	approx. 500m
HCS fiber:	approx. 100 m

Procedure:

1. Select a suitable reference fiber by fiber diameter and type of connector
2. Select a suitable transmitter by wavelength and type of connector
3. Connect the transmitter so that continuous light is emitted
4. Measure the transmission capacity as in 4.2. Measuring the transmission capacity
5. Save the measured value by keeping the **SET REF** button pressed for some time (approx. 3 seconds)
6. Now replace the reference fiber by the path to be measured
7. The attenuation of the cable to be measured is now displayed in **dB**
8. The typical fiber attenuation is calculated as follows:

$$\alpha = \frac{\text{Attenuation [dB] displayed}}{\text{Length of the fiber to be measured [m]} - \text{Length of the reference fiber [m]}} \cdot 1000$$

Example: The typical attenuation of a 1500 m long glass fiber cable is to be determined:

$$\alpha = \frac{4.2 \text{ dB}}{1500 \text{ m} - 1 \text{ m}} \cdot 1000 = 2,8 \frac{\text{dB}}{\text{km}}$$

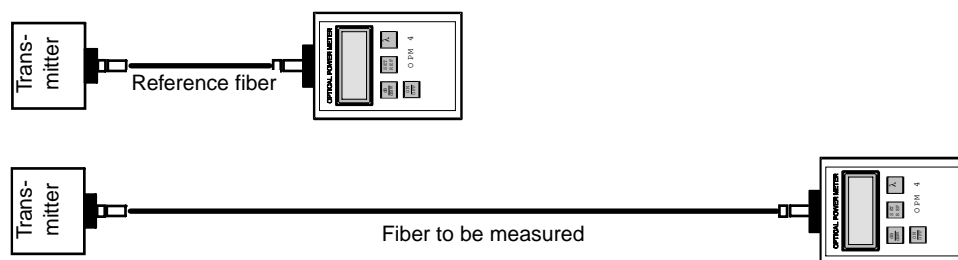



Fig. 13

PSM-FO-Powermeter

FO measuring instrument

5. Sample applications for INTERBUS

 In order to evaluate the optical data transmission in INTERBUS systems, points 5.1., 5.2. and the enclosed INTERBUS installation guideline are relevant.

5.1. Determining the incoming emissivity in an INTERBUS system

Target:

To determine the emissivity in a system **at the end of an FO cable**.

Procedure:

1. Interrupt the bus directly after the master
2. Screw the F-SMA connector off the **receiver** of the device and connect it to the measuring instrument
3. Set the measuring instrument to a wavelength range of 660 nm
4. Select dBm for power measurement
5. The optical level measured appears on the display in **dBm**
6. To evaluate the value displayed, consult the FO installation guidelines for the INTERBUS system
7. Measure the incoming light capacity in **both fibers** of the cable upstream of the receiving device

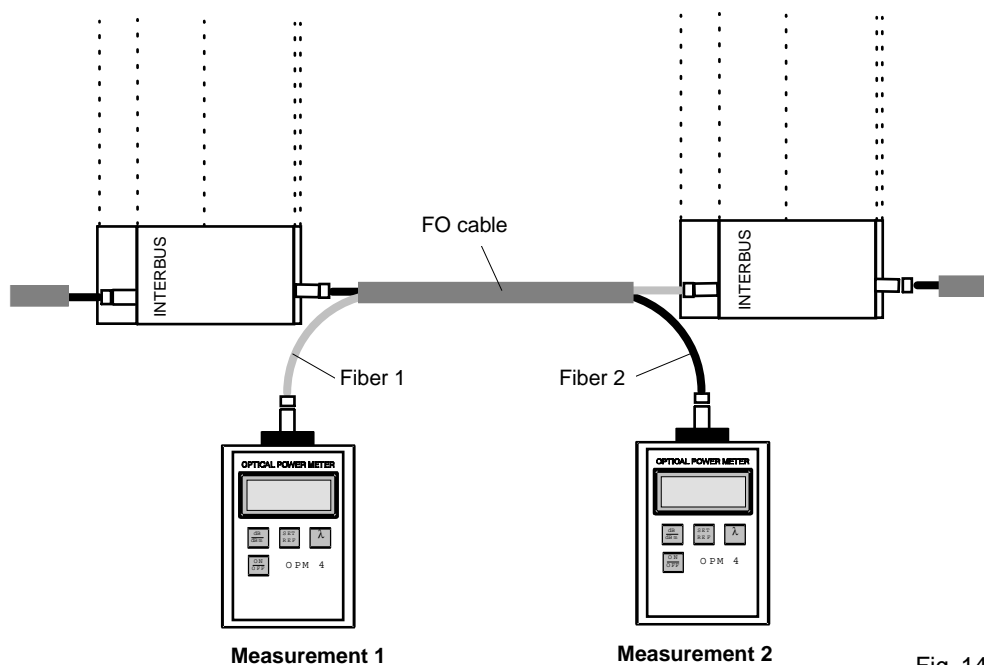

Fig. 14

PSM-FO-Powermeter

FO measuring instrument

5.2. Measuring the transmission capacity of INTERBUS devices

Target:

To determine the transmission capacity of a module.

Procedure:

1. Interrupt the bus directly after the master
2. Connect the enclosed polymer fiber cable¹⁾ between bus device and measuring instrument.
3. Set the measuring instrument to a wavelength range of 660 nm
4. Select **dBm** for power measurement
5. The optical level measured appears on the display in **dBm**
6. Measure **both** transmitters of the bus device (incoming and outgoing remote bus)
7. To evaluate the transmission capacity measured, please consult the technical data of the device or the FO installation guidelines.

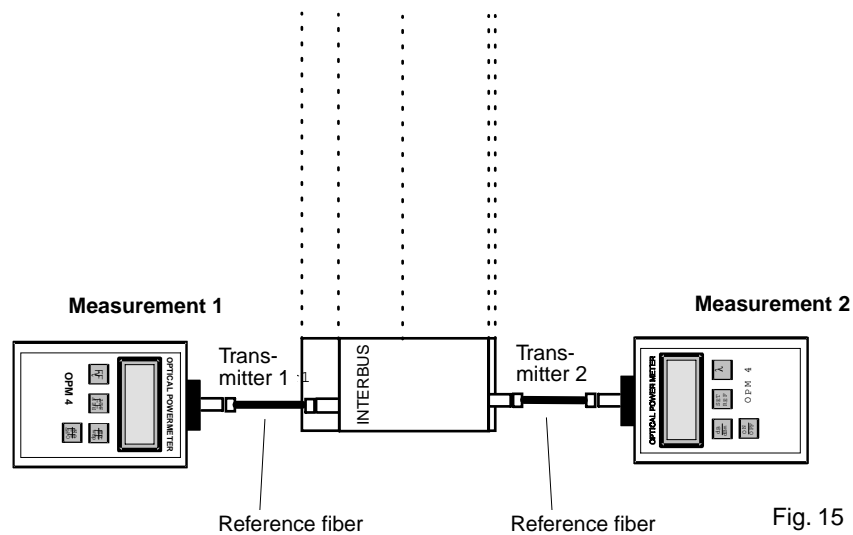

Fig. 15



Additional information on measurements in INTERBUS systems can be found in the enclosed FO installation guidelines.

¹⁾ The polymer fiber cable supplied is a reference cable (see 7.2. Adapter fibers)

PSM-FO-Powermeter

FO measuring instrument

6. The basics of FO measurement technology

6.1. Method of measurement

Two different methods of measurement are used in this manual:

• Power measurement

This method of measurement is used whenever a light source (with or without transmission path) are to be evaluated. This can be either measurement at the end of a transmission path (see 5.1) or direct measurement of a transmitter using a reference fiber (see 5.2).

Power measurement is always carried out in dBm or mW. For measurements in dBm, 0 dBm correspond to an output of 1 mW.

The PSM-FO-POWERMETER displays the optical capacity in the practical form of dBm. Should it be necessary to convert dBm to mW, this is done following the equations below:

a) when the power is known in dBm

b) when the power is known in mW

$$P(\text{mW}) = 1 \text{ mW} \cdot 10^{\frac{P(\text{dBm})}{10 \text{ dBm}}} \quad P(\text{dBm}) = 10 \text{ dBm} \cdot \log \left(\frac{P(\text{mW})}{1 \text{ mW}} \right)$$

• Attenuation measurement

Attenuation measurement is used to determine the attenuation of a transmission path (see 4.1. or 4.2.). This attenuation is not dependent on the capacity of the light source used.

The difference in power between the input power and the output power at the end of the transmission path is determined in dB. Since the output power is smaller than the input power, the attenuation is always positive (> 0).

$$\text{attenuation } a \text{ (dB)} = P_{\text{transmitter}} \text{ (dBm)} - P_{\text{receiver}} \text{ (dBm)}$$

6.2. Effects of ageing⁵⁾



The reduction values listed here have already been fully accounted for in the maximum transmission distances given by Phoenix Contact.

During operation, the optical transmission capacity drops due to ageing of the semi-conductor used. For this reason, the transmission capacity drops by 1.0 dB in the first year and by approx. 0.2 dB per year in the subsequent years. This reduction in transmission capacity is compensated for by the system reserve.

6.3. The effects of temperature



The reduction values listed here have already been fully accounted for in the maximum transmission distances given by Phoenix Contact.

The semi-conductors of FO transmit and receive elements are influenced by the ambient temperature. The values given in the technical data for transmission capacity and receiver sensitivity generally refer to an ambient temperature of +25 °C.

With an ambient temperature of +50 °C, there is a reduction in transmission capacity of approx. 1.2 dB and a reduction in receiver sensitivity of approx. 1.6 dB. Since there is a strong interdependency between temperature and components, the values given here are merely guidelines.

In addition to the drops mentioned, wavelength drift causes a reduction of approx. 1.4 dB when polymer fiber is used.

⁵⁾ The values given here apply to transmitters with a wavelength of 660 nm using polymer fiber cable. If other wavelengths or types of fiber are used, lower values apply.

PSM-FO-Powermeter

FO measuring instrument

6.4. Overview of the various FO types

Type of fiber	Max. distance	Typ. wavelength	Fiber classification (diameter)	Type of connector
Polymer fiber	up to 70m (depends on device)	660 nm	980/1000 µm	F-SMA
HCS fiber	up to 500m (depends on device)	660 nm	200/230 µm	F-SMA
Glass fiber	up to 3500m	850 nm	50/125 µm or 62.5/125 µm	B-FOC (ST) or F-SMA

7. Technical Data

7.1. Measuring instrument

Light-sensitive element:	silicon cell
Wavelengths	660 nm, 780 nm, 850 nm
Measuring range	-70 dBm to +6 dBm
Precision	+/- 0.25 dB
Resolution of display	0.01 dB
Service life of battery	approx. 60 h with 9 V alkaline battery
Ambient temperature range	0 °C to +45 °C
Storage temperature range	-30 °C to +60 °C
Relative humidity:	max. 95 % (non-condensing)
Dimensions (H/W/D)	115/70/25 mm
Weight	180 g

7.2. Adapter fibers

Fiber	Plug	Diameter of the fibers	Wavelength range	Insertion loss based on method 7	Designation
Glass	B-FOC (ST)	50/125 µm	850 nm	0.3 ... 0.8 dB	FO 50/125 ST
Glass	F-SMA type 905	50/125 µm	850 nm	0.35 ... 0.85 dB	FO 50/125 FSMA
HCS	F-SMA type 905	200/230 µm	660 nm & 850 nm	1.0 ... 1.5 dB	HCS 200/230 FSMA
Polymer	F-SMA type 905	980/1000 µm	660 nm	1.5 ... 2.0 dB	POF 980/1000 FSMA

The insertion losses of the fibers have been determined before delivery. We advise checking the attenuation at regular intervals as described in 4.5.

7.3. Calibration service

The PSM-POWERMETER is calibrated before delivery. The precision of the instrument can, however, diminish with time. We therefore advise you to have the measuring instrument calibrated again annually by Phoenix Contact.

If you are interested, please contact our Service Center :

Phoenix Contact GmbH & Co.

Service Center
Flachmarktstraße 8-28
D-32825 Blomberg

Phone: ++49/52 35 - 3 - 00
Fax: ++49/52 35 - 3 - 4 10 60