



Is Now Part of



ON Semiconductor®

To learn more about ON Semiconductor, please visit our website at
www.onsemi.com

ON Semiconductor and the ON Semiconductor logo are trademarks of Semiconductor Components Industries, LLC dba ON Semiconductor or its subsidiaries in the United States and/or other countries. ON Semiconductor owns the rights to a number of patents, trademarks, copyrights, trade secrets, and other intellectual property. A listing of ON Semiconductor's product/patent coverage may be accessed at www.onsemi.com/site/pdf/Patent-Marking.pdf. ON Semiconductor reserves the right to make changes without further notice to any products herein. ON Semiconductor makes no warranty, representation or guarantee regarding the suitability of its products for any particular purpose, nor does ON Semiconductor assume any liability arising out of the application or use of any product or circuit, and specifically disclaims any and all liability, including without limitation special, consequential or incidental damages. Buyer is responsible for its products and applications using ON Semiconductor products, including compliance with all laws, regulations and safety requirements or standards, regardless of any support or applications information provided by ON Semiconductor. "Typical" parameters which may be provided in ON Semiconductor data sheets and/or specifications can and do vary in different applications and actual performance may vary over time. All operating parameters, including "Typicals" must be validated for each customer application by customer's technical experts. ON Semiconductor does not convey any license under its patent rights nor the rights of others. ON Semiconductor products are not designed, intended, or authorized for use as a critical component in life support systems or any FDA Class 3 medical devices or medical devices with a same or similar classification in a foreign jurisdiction or any devices intended for implantation in the human body. Should Buyer purchase or use ON Semiconductor products for any such unintended or unauthorized application, Buyer shall indemnify and hold ON Semiconductor and its officers, employees, subsidiaries, affiliates, and distributors harmless against all claims, costs, damages, and expenses, and reasonable attorney fees arising out of, directly or indirectly, any claim of personal injury or death associated with such unintended or unauthorized use, even if such claim alleges that ON Semiconductor was negligent regarding the design or manufacture of the part. ON Semiconductor is an Equal Opportunity/Affirmative Action Employer. This literature is subject to all applicable copyright laws and is not for resale in any manner.

FAN7601

Green Current Mode PWM Controller

Features

- Green Current Mode PWM Control
- Low Operating Current: Max 4mA
- Burst Mode Operation
- Internal High Voltage Start-up Switch
- Under Voltage Lockout (UVLO): 12V/8V
- Latch Protection & Soft Start Function
- Over Voltage Protection: 19V
- Operating Frequency up to 300kHz
- Max Duty Cycle: 95%

Typical Applications

- Off-Line Adapter Applications
- Auxiliary Power Supplies

Description

The FAN7601 is a green programmable frequency current mode PWM controller. It is specially designed for the off-line adapter application and the auxiliary power supplies which require high efficiency at a light load and no load. The internal high voltage start-up switch and the burst mode reduce the power loss. The FAN7601 includes some protections such as latch protection and over voltage protection. The latch protection can be used for over voltage protection and/or thermal protection and so on. And the soft start prevents the output voltage over shoot at start up.

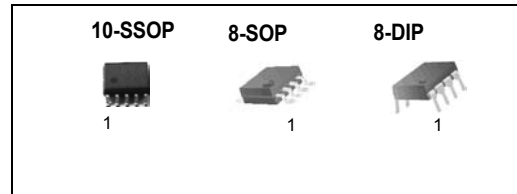

Internal Block Diagram

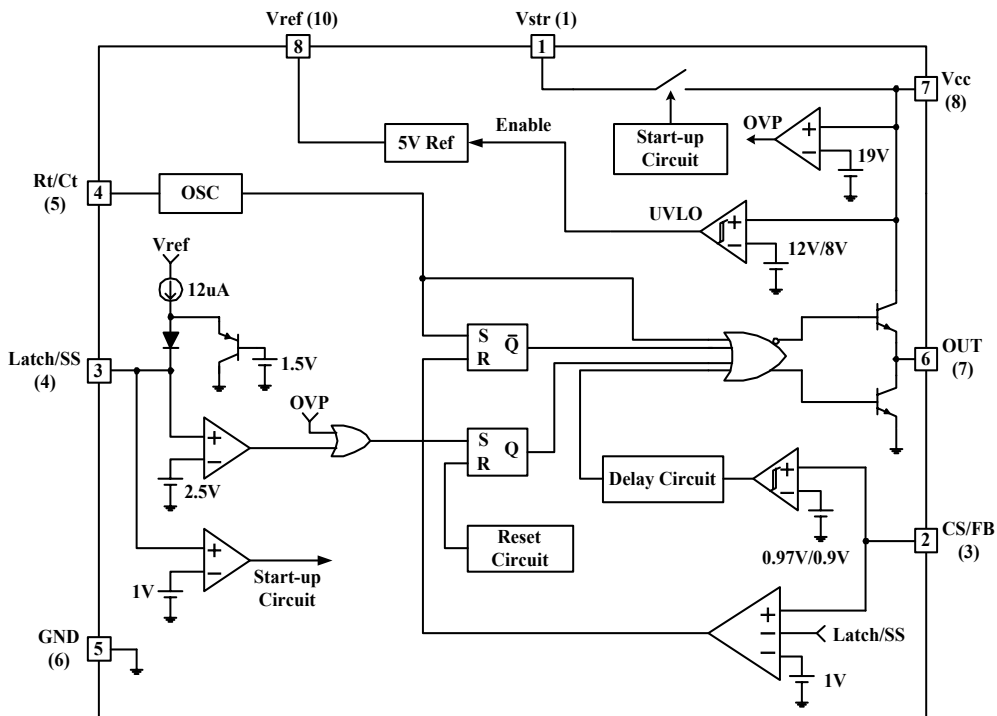

* () is 10-SSOP PIN Number

Pin Assignments

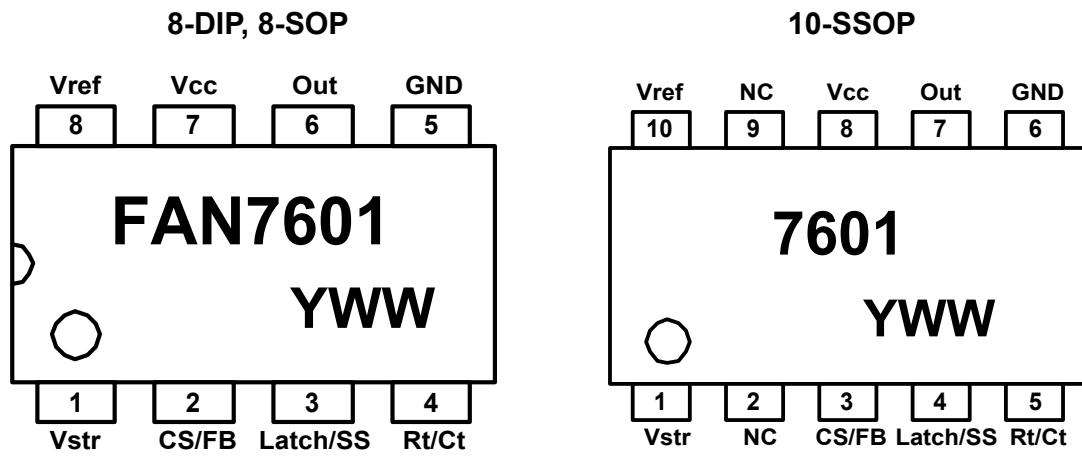

Pin Definitions

Pin Number	Pin Name	Pin Function Description
1 (1)	Vstr	Start-up
2 (3)	CS/FB	Current Sense and Feedback
3 (4)	Latch/SS	Latch Protection and Soft Start
4 (5)	Rt/Ct	Oscillator Timing
5 (6)	GND	Ground
6 (7)	Out	Gate Drive Output
7 (8)	VCC	IC Power Supply
8 (10)	Vref	Voltage Reference

*() is 10-SSOP PIN Number

Absolute Maximum Ratings

(Ta = 25°C, unless otherwise specified)

Characteristics	Symbol	Value	Unit
Supply Voltage	VCC	20	V
Input Voltage CS/FB	VCS/FB	-0.3 to 20	V
Operating Temperature	TOPR	-25 to +125	°C
Storage Temperature	TSTG	-55 to +150	°C
Junction Temperature	Tj	150	°C
Output Current	IO	250	mA
Vstr Input Voltage	Vstr	500	V
ESD Capability, HBM Model (All pins except Vcc and Vstr)	-	2.0	kV
ESD Capability, Machine Model	-	300	V
Thermal Resistance, Junction to Air	8-DIP	100	°C/W
	8-SOP	180	
	10-SSOP	130	

Electrical Characteristics

($T_a = -25^{\circ}\text{C} \sim 125^{\circ}\text{C}$, $V_{CC} = 14\text{V}$, $R_t = 9.5\text{k}\Omega$, $C_t = 2.2\text{nF}$ unless otherwise specified)

Characteristics	Symbol	Conditions	Min.	Typ.	Max.	Unit
REFERENCE SECTION						
Reference Output Voltage	V_{ref}	$I_O = 1\text{mA}$	4.85	5.00	5.15	V
Line Regulation	ΔV_{ref1}	$V_{CC} = 10\text{V} \sim 18\text{V}$	-	10	20	mV
Load Regulation	ΔV_{ref2}	$I_O = 1\text{mA} \sim 10\text{mA}$	-	20	30	mV
OSCILLATOR SECTION						
Initial Accuracy	FOSC	-	90	100	110	kHz
Voltage Stability	STV	$V_{CC} = 10\text{V} \sim 18\text{V}$	-	1.0	1.5	%
Amplitude	VOCS	V_{pin4} peak-to-peak	-	1.25	-	V
PWM SECTION						
CS/FB Threshold Voltage1	VCS/FB1	-	0.9	1.0	1.1	V
Maximum Duty Cycle	DMAX	$T_a = 25^{\circ}\text{C}$	92	95	98	%
Minimum Duty Cycle	DMIN	-	-	-	0	%
BURST MODE SECTION						
CS/FB Threshold Voltage2 ⁽¹⁾	VCS/FB2	-	0.77	0.97	1.17	V
CS/FB Threshold Voltage3 ⁽¹⁾	VCS/FB3	-	0.7	0.9	1.1	V
SOFT START SECTION						
Soft Start Current	ISS	$V_{pin3} = \text{GND}$	9	12	15	μA
Soft Start Limit Voltage ⁽²⁾	VSL	$I_{SS} = 1\mu\text{A}$	1.2	1.5	1.8	V
PROTECTION SECTION						
Latch Voltage	VLATCH	-	2.25	2.5	2.75	V
Over Voltage Protection	VOVP	-	18	19	20	V
UVLO SECTION						
Start Threshold Voltage	V_{tH}	-	11	12	13	V
Minimum Operating Voltage	V_{tL}	-	7	8	9	V
TOTAL CURRENT SECTION						
Operating Supply Current	IOP	-	-	3	4	mA
OUTPUT SECTION						
Low Output Voltage	VOL	$T_a = 25^{\circ}\text{C}$, $I_O = 100\text{mA}$	-	2	2.5	V
High Output Voltage	VOH	$T_a = 25^{\circ}\text{C}$, $I_O = -100\text{mA}$	11.5	12	14	V
Rising Time ⁽¹⁾	T_r	$T_a = 25^{\circ}\text{C}$, $C_l = 1\text{nF}$	-	45	150	ns
Falling Time ⁽¹⁾	T_f	$T_a = 25^{\circ}\text{C}$, $C_l = 1\text{nF}$	-	35	150	ns
START UP SECTION						
VSTR Start-up Current	Istr	$V_{str} = 30\text{V}$, $T_a = 25^{\circ}\text{C}$	0.5	1	1.5	mA

Note:

1. These parameters, although guaranteed, are not 100% tested in production.
2. It is recommended to connect 1M Ω resistor between the Latch/SS pin and GND to prevent abnormal operation of the latch protection by noise coupling.

Typical Performance Characteristics

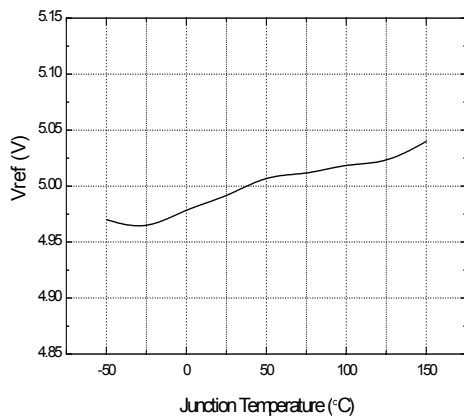

Figure 1. Trimmed Reference Voltage

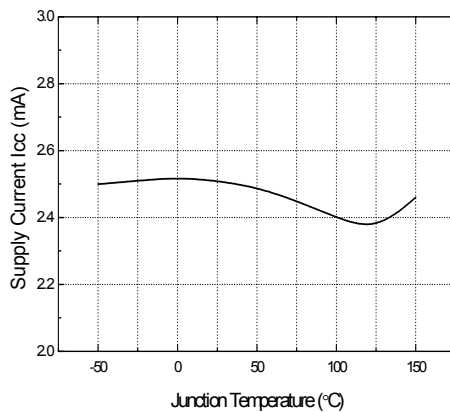

Figure 2. Supply Current

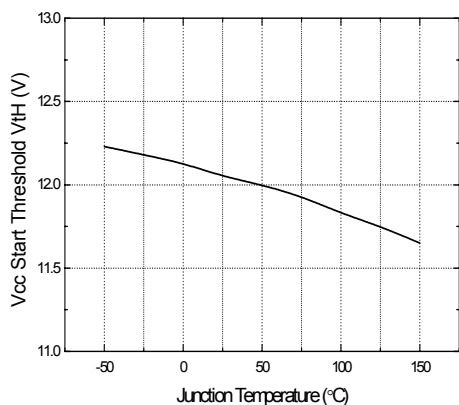

Figure 3. Vcc Start Threshold Voltage

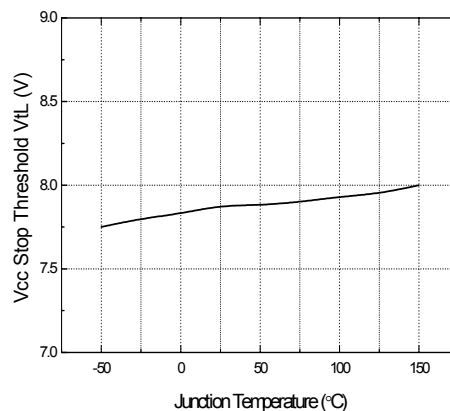

Figure 4. Vcc Stop Threshold Voltage

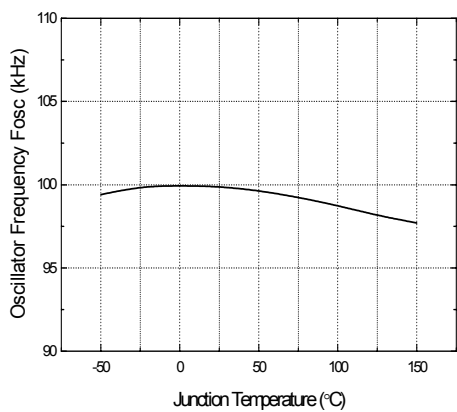

Figure 5. Oscillator Frequency

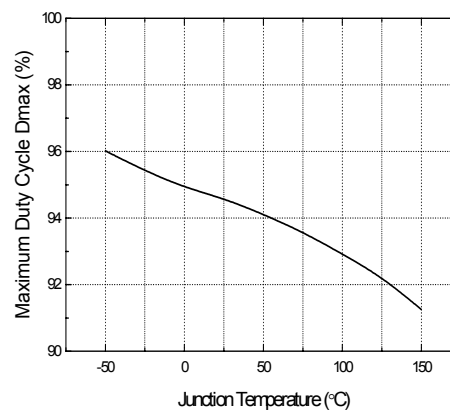

Figure 6. Maximum Duty Cycle

Typical Performance Characteristics (Continued)

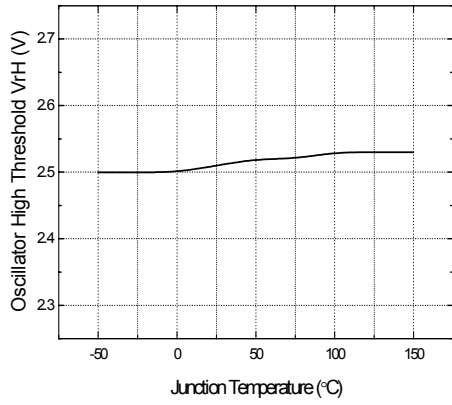

Figure 7. Oscillator High Threshold Voltage

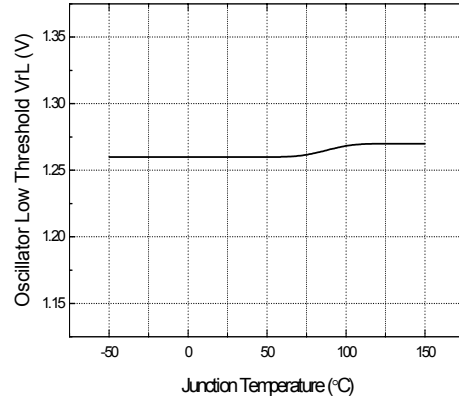

Figure 8. Oscillator Low Threshold Voltage

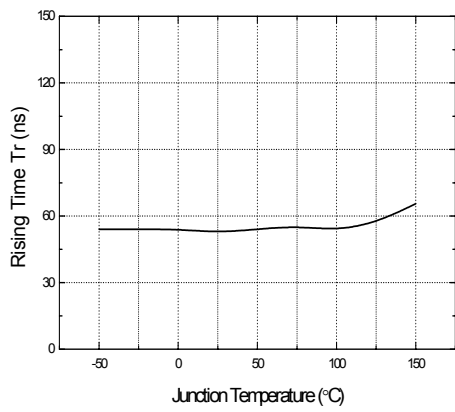

Figure 9. Output Rising Time

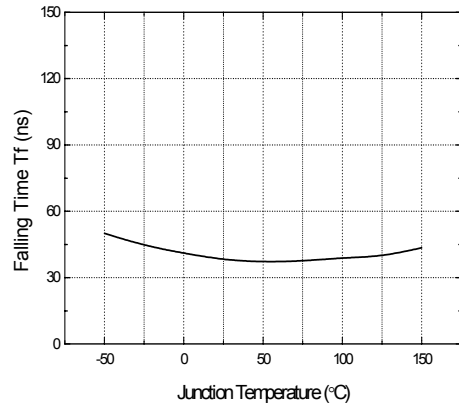

Figure 10. Output Falling Time

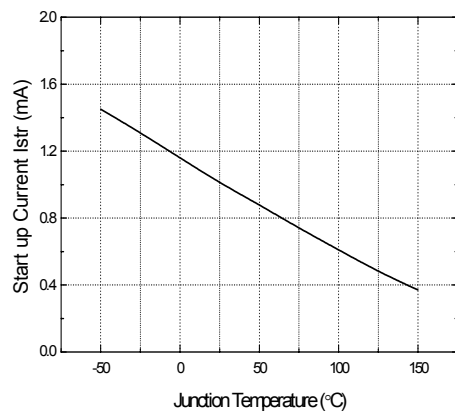

Figure 11. Start-up Current

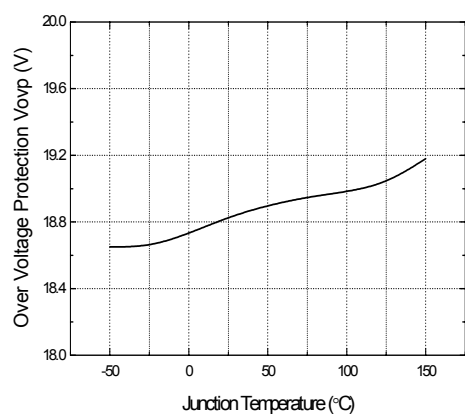

Figure 12. Over Voltage Protection Level

Typical Performance Characteristics (Continued)

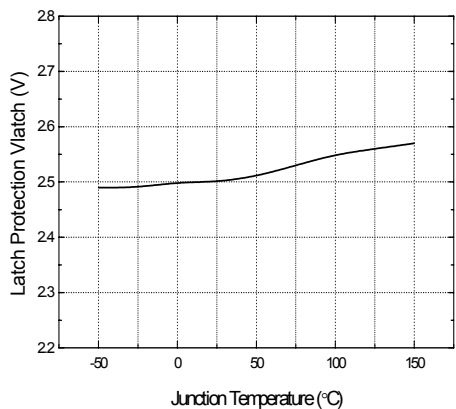

Figure 13. Latch Protection Voltage

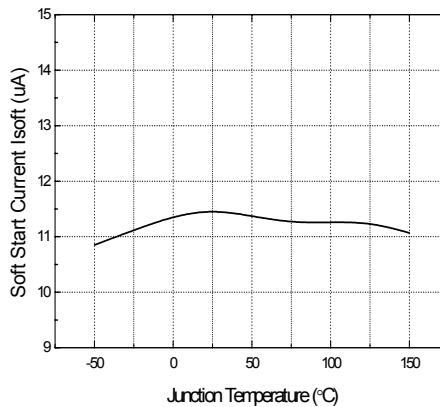

Figure 14. Soft Start Current

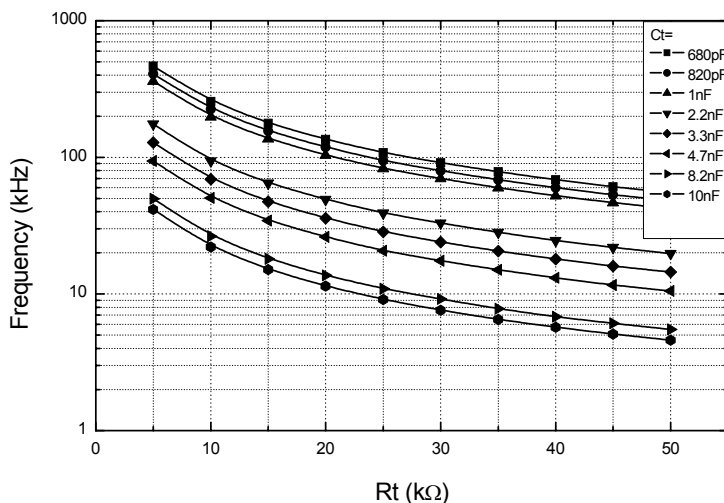
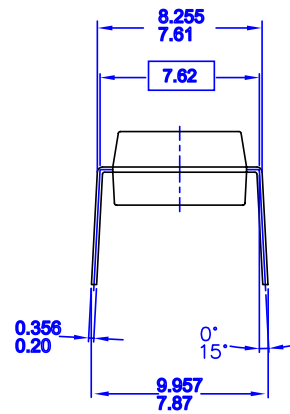
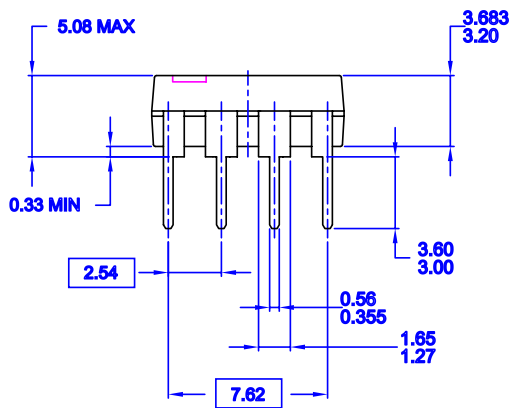
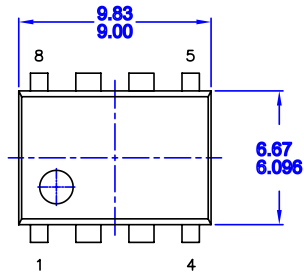

Figure 15. Oscillator Frequency Characteristic

Mechanical Dimensions

8DIP



- NOTES: UNLESS OTHERWISE SPECIFIED
- A) THIS PACKAGE CONFORMS TO JEDEC MS-001 VARIATION BA
 - B) ALL DIMENSIONS ARE IN MILLIMETERS.
 - C) DIMENSIONS ARE EXCLUSIVE OF BURRS, MOLD FLASH, AND TIE BAR EXTRUSIONS.
 - D) DIMENSIONS AND TOLERANCES PER ASME Y14.5M-1994

MKT-N08FrevB

Mechanical Dimensions (Unit: mm) (Continued)

Package

8-SOP

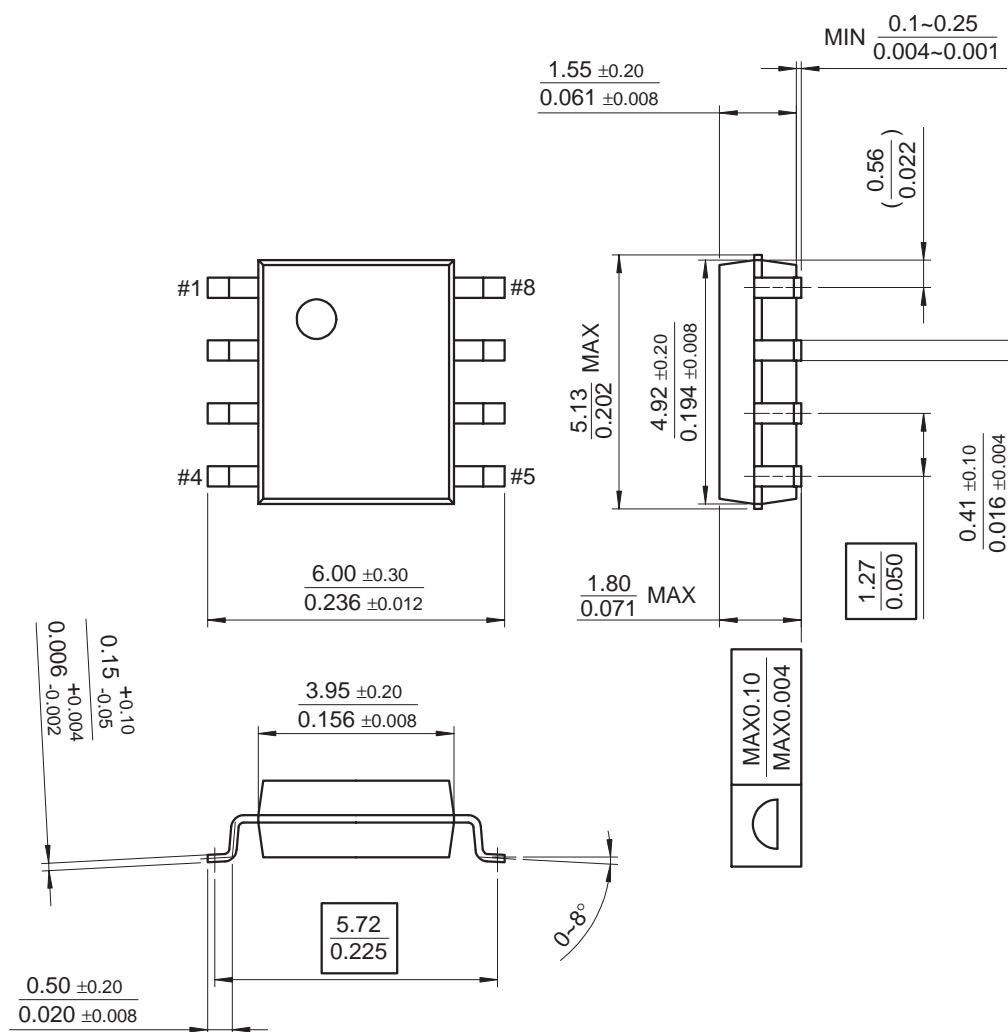

Ordering Information

Device	Package	Operating Temp.
FAN7601N	8-DIP	-25°C ~ 125°C
FAN7601M	8-SOP	
FAN7601G	10-SSOP	

DISCLAIMER

FAIRCHILD SEMICONDUCTOR RESERVES THE RIGHT TO MAKE CHANGES WITHOUT FURTHER NOTICE TO ANY PRODUCTS HEREIN TO IMPROVE RELIABILITY, FUNCTION OR DESIGN. FAIRCHILD DOES NOT ASSUME ANY LIABILITY ARISING OUT OF THE APPLICATION OR USE OF ANY PRODUCT OR CIRCUIT DESCRIBED HEREIN; NEITHER DOES IT CONVEY ANY LICENSE UNDER ITS PATENT RIGHTS, NOR THE RIGHTS OF OTHERS.

LIFE SUPPORT POLICY

FAIRCHILD'S PRODUCTS ARE NOT AUTHORIZED FOR USE AS CRITICAL COMPONENTS IN LIFE SUPPORT DEVICES OR SYSTEMS WITHOUT THE EXPRESS WRITTEN APPROVAL OF THE PRESIDENT OF FAIRCHILD SEMICONDUCTOR CORPORATION. As used herein:

1. Life support devices or systems are devices or systems which, (a) are intended for surgical implant into the body, or (b) support or sustain life, and (c) whose failure to perform when properly used in accordance with instructions for use provided in the labeling, can be reasonably expected to result in a significant injury of the user.
2. A critical component in any component of a life support device or system whose failure to perform can be reasonably expected to cause the failure of the life support device or system, or to affect its safety or effectiveness.

ON Semiconductor and  are trademarks of Semiconductor Components Industries, LLC dba ON Semiconductor or its subsidiaries in the United States and/or other countries. ON Semiconductor owns the rights to a number of patents, trademarks, copyrights, trade secrets, and other intellectual property. A listing of ON Semiconductor's product/patent coverage may be accessed at www.onsemi.com/site/pdf/Patent-Marking.pdf. ON Semiconductor reserves the right to make changes without further notice to any products herein. ON Semiconductor makes no warranty, representation or guarantee regarding the suitability of its products for any particular purpose, nor does ON Semiconductor assume any liability arising out of the application or use of any product or circuit, and specifically disclaims any and all liability, including without limitation special, consequential or incidental damages. Buyer is responsible for its products and applications using ON Semiconductor products, including compliance with all laws, regulations and safety requirements or standards, regardless of any support or applications information provided by ON Semiconductor. "Typical" parameters which may be provided in ON Semiconductor data sheets and/or specifications can and do vary in different applications and actual performance may vary over time. All operating parameters, including "Typicals" must be validated for each customer application by customer's technical experts. ON Semiconductor does not convey any license under its patent rights nor the rights of others. ON Semiconductor products are not designed, intended, or authorized for use as a critical component in life support systems or any FDA Class 3 medical devices or medical devices with a same or similar classification in a foreign jurisdiction or any devices intended for implantation in the human body. Should Buyer purchase or use ON Semiconductor products for any such unintended or unauthorized application, Buyer shall indemnify and hold ON Semiconductor and its officers, employees, subsidiaries, affiliates, and distributors harmless against all claims, costs, damages, and expenses, and reasonable attorney fees arising out of, directly or indirectly, any claim of personal injury or death associated with such unintended or unauthorized use, even if such claim alleges that ON Semiconductor was negligent regarding the design or manufacture of the part. ON Semiconductor is an Equal Opportunity/Affirmative Action Employer. This literature is subject to all applicable copyright laws and is not for resale in any manner.

PUBLICATION ORDERING INFORMATION

LITERATURE FULFILLMENT:

Literature Distribution Center for ON Semiconductor
19521 E. 32nd Pkwy, Aurora, Colorado 80011 USA
Phone: 303-675-2175 or 800-344-3860 Toll Free USA/Canada
Fax: 303-675-2176 or 800-344-3867 Toll Free USA/Canada
Email: orderlit@onsemi.com

N. American Technical Support: 800-282-9855 Toll Free
USA/Canada
Europe, Middle East and Africa Technical Support:
Phone: 421 33 790 2910
Japan Customer Focus Center
Phone: 81-3-5817-1050

ON Semiconductor Website: www.onsemi.com
Order Literature: <http://www.onsemi.com/orderlit>
For additional information, please contact your local
Sales Representative