

High Voltage Phase Control Thyristor, 16 A

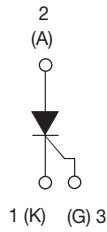

FEATURES

- Designed and qualified for industrial level
- Fully isolated package ($V_{INS} = 2500 V_{RMS}$)
- UL E78996 approved
- 125 °C max. operating junction temperature
- Material categorization:
For definitions of compliance please see www.vishay.com/doc?99912



APPLICATIONS

- Typical usage is in input rectification crowbar (soft start) and AC switch in motor control, UPS, welding, and battery charge

DESCRIPTION

The VS-16TTS..FP... high voltage series of silicon controlled rectifiers are specifically designed for medium power switching and phase control applications. The glass passivation technology used has reliable operation up to 125 °C junction temperature.

PRODUCT SUMMARY	
Package	TO-220AB FP
Diode variation	Single SCR
$I_{T(AV)}$	10 A
V_{DRM}/V_{RRM}	800 V, 1200 V
V_{TM}	1.4 V
I_{GT}	60 mA
T_J	- 40 °C to 125 °C

OUTPUT CURRENT IN TYPICAL APPLICATIONS			
APPLICATIONS	SINGLE-PHASE BRIDGE	THREE-PHASE BRIDGE	UNITS
Capacitive input filter $T_A = 55$ °C, $T_J = 125$ °C, common heatsink of 1 °C/W	13.5	17	A

MAJOR RATINGS AND CHARACTERISTICS			
PARAMETER	TEST CONDITIONS	VALUES	UNITS
$I_{T(AV)}$	Sinusoidal waveform	10	A
I_{RMS}		16	
V_{DRM}/V_{RRM}		800/1200	V
I_{TSM}		200	A
V_T	10 A, $T_J = 25$ °C	1.4	V
dV/dt		500	V/μs
dI/dt		150	A/μs
T_J	Range	- 40 to 125	°C

VOLTAGE RATINGS			
PART NUMBER	V_{RRM} , MAXIMUM PEAK REVERSE VOLTAGE V	V_{DRM} , MAXIMUM PEAK DIRECT VOLTAGE V	I_{RRM}/I_{DRM} AT 125 °C mA
VS-16TTS08FPPbF, VS-16TTS08FP-M3	800	800	10
VS-16TTS12FPPbF, VS-16TTS12FP-M3	1200	1200	



ABSOLUTE MAXIMUM RATINGS						
PARAMETER	SYMBOL	TEST CONDITIONS	VALUES		UNITS	
			TYP.	MAX.		
Maximum average on-state current	$I_{T(AV)}$	$T_C = 70\text{ }^\circ\text{C}$, 180° conduction, half sine wave	10		A	
Maximum RMS on-state current	I_{RMS}		16			
Maximum peak, one-cycle, non-repetitive surge current	I_{TSM}	10 ms sine pulse, rated V_{RRM} applied	170			
		10 ms sine pulse, no voltage reapplied	200			
Maximum I^2t for fusing	I^2t	10 ms sine pulse, rated V_{RRM} applied	144		A^2s	
		10 ms sine pulse, no voltage reapplied	200			
Maximum $I^2\sqrt{t}$ for fusing	$I^2\sqrt{t}$	$t = 0.1$ to 10 ms, no voltage reapplied	2000		$A^2\sqrt{s}$	
Maximum on-state voltage drop	V_{TM}	10 A, $T_J = 25\text{ }^\circ\text{C}$	1.4		V	
On-state slope resistance	r_t	$T_J = 125\text{ }^\circ\text{C}$	24.0		$m\Omega$	
Threshold voltage	$V_{T(TO)}$		1.1		V	
Maximum reverse and direct leakage current	I_{RM}/I_{DM}	$V_R = \text{Rated } V_{RRM}/V_{DRM}$	$T_J = 25\text{ }^\circ\text{C}$	0.5		mA
			$T_J = 125\text{ }^\circ\text{C}$	10		
Holding current	I_H	Anode supply = 6 V, resistive load, initial $I_T = 1$ A 16TTS08FP, 16TTS12FP, $T_J = 25\text{ }^\circ\text{C}$	-	150		
Maximum latching current	I_L	Anode supply = 6 V, resistive load, $T_J = 25\text{ }^\circ\text{C}$	200			
Maximum rate of rise of off-state voltage	dV/dt	$T_J = T_{J\text{ max.}}$, linear to 80 %, $V_{DRM} = R_g - k = \text{Open}$	500		$V/\mu s$	
Maximum rate of rise of turned-on current	di/dt		150		$A/\mu s$	

TRIGGERING					
PARAMETER	SYMBOL	TEST CONDITIONS	VALUES	UNITS	
Maximum peak gate power	P_{GM}		8.0	W	
Maximum average gate power	$P_{G(AV)}$		2.0		
Maximum peak positive gate current	$+ I_{GM}$		1.5	A	
Maximum peak negative gate voltage	$- V_{GM}$		10	V	
Maximum required DC gate current to trigger	I_{GT}	Anode supply = 6 V, resistive load, $T_J = -10\text{ }^\circ\text{C}$	90	mA	
		Anode supply = 6 V, resistive load, $T_J = 25\text{ }^\circ\text{C}$	60		
		Anode supply = 6 V, resistive load, $T_J = 125\text{ }^\circ\text{C}$	35		
Maximum required DC gate voltage to trigger	V_{GT}	Anode supply = 6 V, resistive load, $T_J = -10\text{ }^\circ\text{C}$	3.0	V	
		Anode supply = 6 V, resistive load, $T_J = 25\text{ }^\circ\text{C}$	2.0		
		Anode supply = 6 V, resistive load, $T_J = 125\text{ }^\circ\text{C}$	1.0		
Maximum DC gate voltage not to trigger	V_{GD}	$T_J = 125\text{ }^\circ\text{C}$, $V_{DRM} = \text{Rated value}$	0.25		
Maximum DC gate current not to trigger	I_{GD}		2.0		mA

SWITCHING					
PARAMETER	SYMBOL	TEST CONDITIONS	VALUES	UNITS	
Typical turn-on time	t_{gt}	$T_J = 25\text{ }^\circ\text{C}$	0.9	μs	
Typical reverse recovery time	t_{rr}	$T_J = 125\text{ }^\circ\text{C}$	4		
Typical turn-off time	t_q		110		



THERMAL AND MECHANICAL SPECIFICATIONS				
PARAMETER	SYMBOL	TEST CONDITIONS	VALUES	UNITS
Maximum junction and storage temperature range	T_J, T_{Stg}		- 40 to 125	°C
Maximum thermal resistance, junction to case	R_{thJC}	DC operation	2.5	°C/W
Maximum thermal resistance, junction to ambient	R_{thJA}		62	
Typical thermal resistance, case to heatsink	R_{thCS}	Mounting surface, smooth and greased	0.5	
Approximate weight			2	g
			0.07	oz.
Mounting torque	minimum		6 (5)	kgf · cm
	maximum		12 (10)	(lbf · in)
Marking device		Case style TO-220AB FULL-PAK (94/V0)	16TTS08FP	
			16TTS12FP	

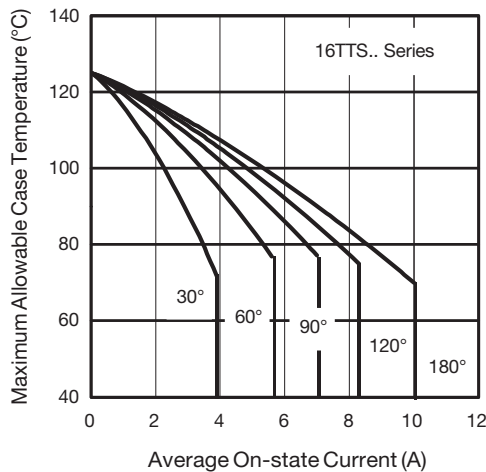

Fig. 1 - Current Rating Characteristics

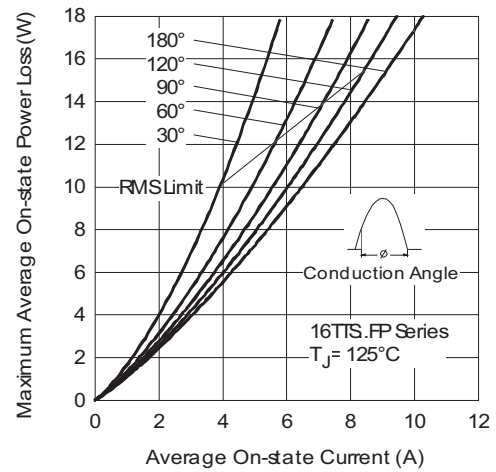

Fig. 3 - On-State Power Loss Characteristics

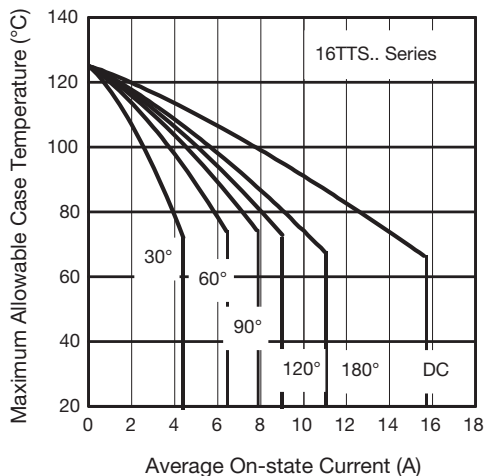

Fig. 2 - Current Rating Characteristics

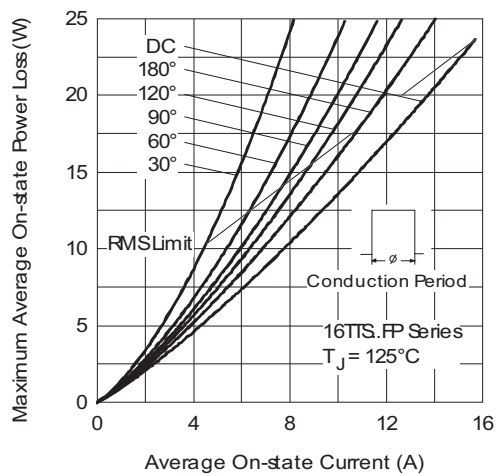

Fig. 4 - On-State Power Loss Characteristics

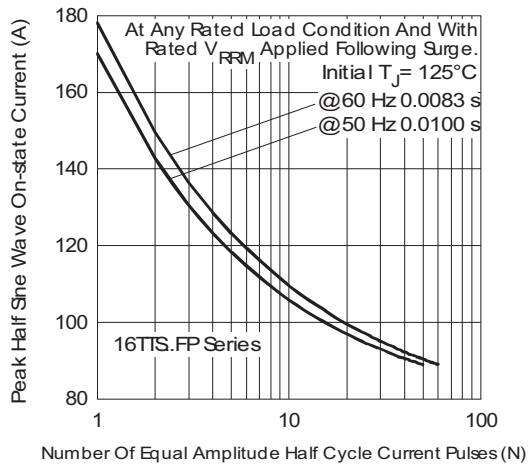

Fig. 5 - Maximum Non-Repetitive Surge Current

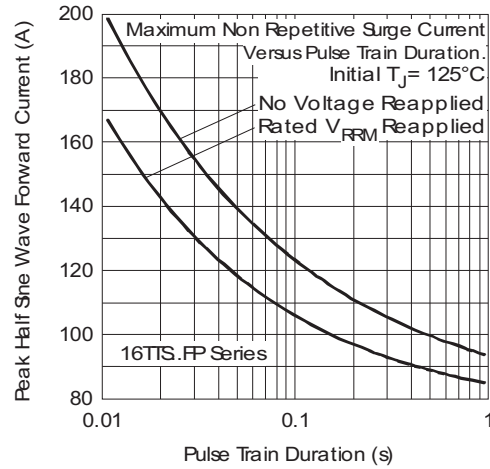

Fig. 6 - Maximum Non-Repetitive Surge Current

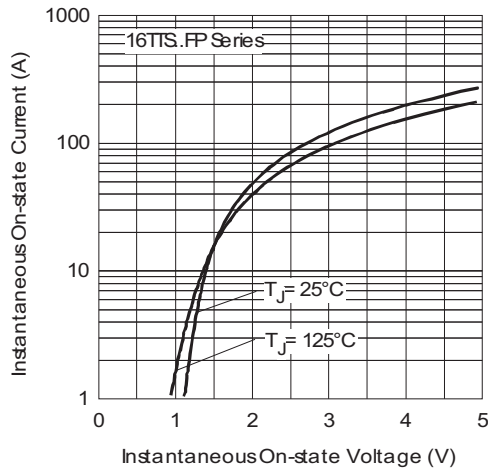

Fig. 7 - On-State Voltage Drop Characteristics

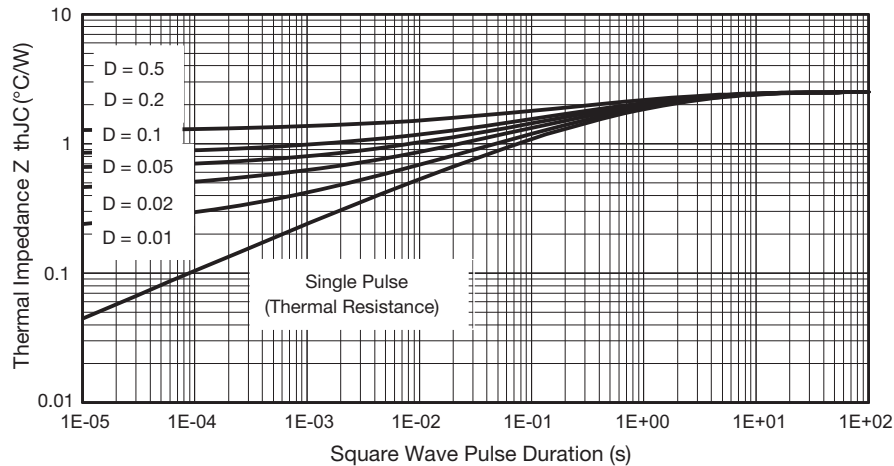

Fig. 8 - Thermal Impedance Z_{thJC} Characteristics

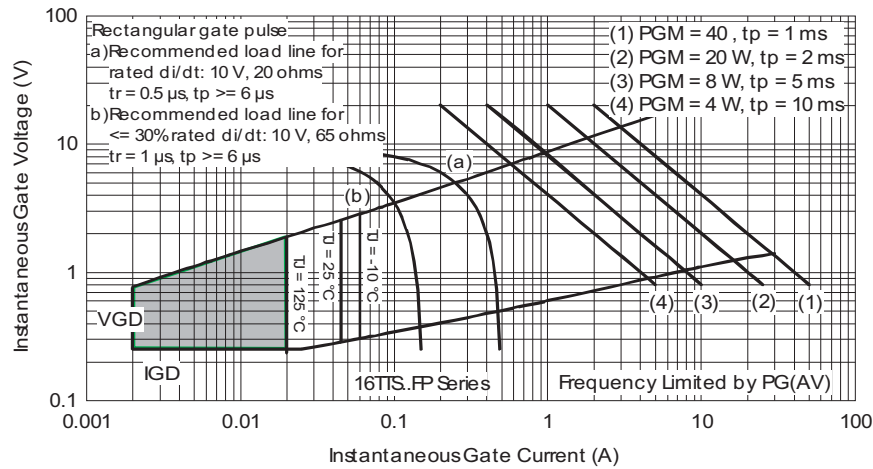

Fig. 9 - Gate Characteristics

ORDERING INFORMATION TABLE

Device code	VS-	16	T	T	S	12	FP	PbF
	1	2	3	4	5	6	7	8

- 1** - Vishay Semiconductors product
- 2** - Current rating, RMS value
- 3** - Circuit configuration:
T = Single thyristor
- 4** - Package:
T = TO-220AB
- 5** - Type of silicon:
S = Converter grade
- 6** - Voltage code x 100 = V_{RRM} — 08 = 800 V
12 = 1200 V
- 7** - FULL-PAK
- 8** - Environmental digit:
PbF = Lead (Pb)-free and RoHS compliant
-M3 = Halogen-free, RoHS compliant, and terminations lead (Pb)-free

ORDERING INFORMATION (Example)			
PREFERRED P/N	QUANTITY PER T/R	MINIMUM ORDER QUANTITY	PACKAGING DESCRIPTION
VS-16TTS08FPPbF	50	1000	Antistatic plastic tubes
VS-16TTS08FP-M3	50	1000	Antistatic plastic tubes
VS-16TTS12FPPbF	50	1000	Antistatic plastic tubes
VS-16TTS12FP-M3	50	1000	Antistatic plastic tubes

LINKS TO RELATED DOCUMENTS	
Dimensions	www.vishay.com/doc?95072
Part marking information	TO-220FP PbF www.vishay.com/doc?95069
	TO-220FP -M3 www.vishay.com/doc?95456



DIMENSIONS in millimeters

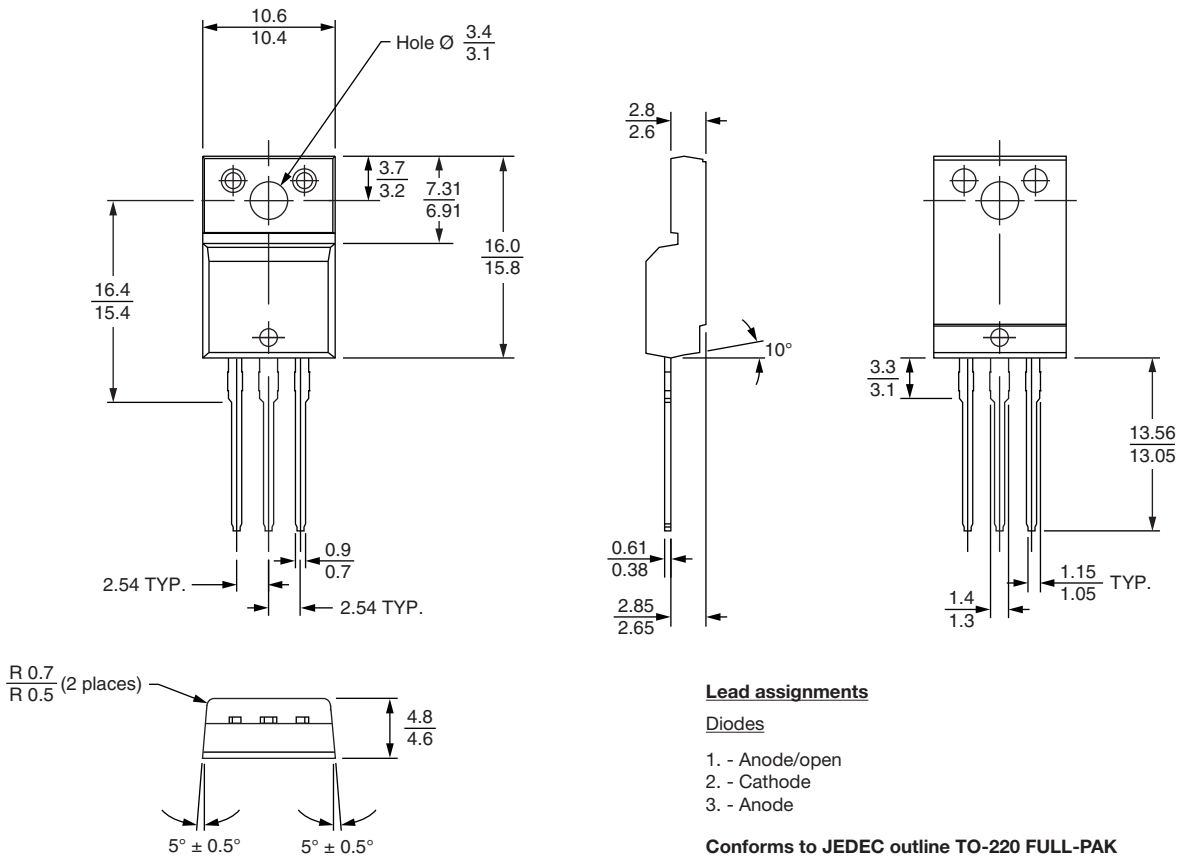



Disclaimer

ALL PRODUCT, PRODUCT SPECIFICATIONS AND DATA ARE SUBJECT TO CHANGE WITHOUT NOTICE TO IMPROVE RELIABILITY, FUNCTION OR DESIGN OR OTHERWISE.

Vishay Intertechnology, Inc., its affiliates, agents, and employees, and all persons acting on its or their behalf (collectively, "Vishay"), disclaim any and all liability for any errors, inaccuracies or incompleteness contained in any datasheet or in any other disclosure relating to any product.

Vishay makes no warranty, representation or guarantee regarding the suitability of the products for any particular purpose or the continuing production of any product. To the maximum extent permitted by applicable law, Vishay disclaims (i) any and all liability arising out of the application or use of any product, (ii) any and all liability, including without limitation special, consequential or incidental damages, and (iii) any and all implied warranties, including warranties of fitness for particular purpose, non-infringement and merchantability.

Statements regarding the suitability of products for certain types of applications are based on Vishay's knowledge of typical requirements that are often placed on Vishay products in generic applications. Such statements are not binding statements about the suitability of products for a particular application. It is the customer's responsibility to validate that a particular product with the properties described in the product specification is suitable for use in a particular application. Parameters provided in datasheets and / or specifications may vary in different applications and performance may vary over time. All operating parameters, including typical parameters, must be validated for each customer application by the customer's technical experts. Product specifications do not expand or otherwise modify Vishay's terms and conditions of purchase, including but not limited to the warranty expressed therein.

Except as expressly indicated in writing, Vishay products are not designed for use in medical, life-saving, or life-sustaining applications or for any other application in which the failure of the Vishay product could result in personal injury or death. Customers using or selling Vishay products not expressly indicated for use in such applications do so at their own risk. Please contact authorized Vishay personnel to obtain written terms and conditions regarding products designed for such applications.

No license, express or implied, by estoppel or otherwise, to any intellectual property rights is granted by this document or by any conduct of Vishay. Product names and markings noted herein may be trademarks of their respective owners.