

Cree® 5mm Round LED C503C-WAS/WAN

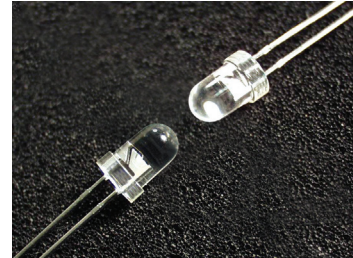

PRODUCT DESCRIPTION

Round LEDs offer superior light output for excellent readability in sunlight and dependable performance. They provide extremely stable light output over long periods of time.

These lamps are made with an advanced optical grade epoxy offering superior high temperature and high moisture resistance performance in lighting and illumination applications.

FEATURES

- Size (mm): 5
- Color Temperatures:
Cool White :
Min . (4600K) / Typical (9000K)
- Luminous Intensity (mcd)
C503C-WAS/WAN:
(16800-46100)
- Viewing angle:
C503C-WAS/WAN: 15 degree
- Lead-Free
- RoHS Compliant

APPLICATIONS

- Torch
- Light Strip
- Channel Letter
- Retail Display Lighting

ABSOLUTE MAXIMUM RATINGS ($T_A = 25^\circ\text{C}$)

Items	Symbol	Absolute Maximum Rating	Unit
Forward Current	I_F	30	mA
Peak Forward Current ^{Note}	I_{FP}	100	mA
Reverse Voltage	V_R	5	V
Power Dissipation	P_D	120	mW
Operation Temperature	T_{opr}	-40 ~ +95	$^\circ\text{C}$
Storage Temperature	T_{stg}	-40 ~ +100	$^\circ\text{C}$
Lead Soldering Temperature	T_{sol}	Max. 260 $^\circ\text{C}$ for 3 sec. max. (3 mm from the base of the epoxy bulb)	

Note: Pulse width ≤ 0.1 msec, duty $\leq 1/10$.

TYPICAL ELECTRICAL & OPTICAL CHARACTERISTICS ($T_A = 25^\circ\text{C}$)

Characteristics	Color	Symbol	Condition	Unit	Minimum	Typical	Maximum
Forward Voltage	WAS/WAN	V_F	$I_F = 20$ mA	V		3.2	4.0
Reverse Current	WAS/WAN	I_R	$V_R = 5$ V	μA			100
Luminous Intensity	WAS/WAN	I_V	$I_F = 20$ mA	mcd	16800	35000	
Chromaticity Coordinates	WAS/WAN	x	$I_F = 20$ mA			0.2895	
		y	$I_F = 20$ mA			0.2905	
50% Power Angle	WAS/WAN	$2\theta_{1/2}$	$I_F = 20$ mA	deg		15	

INTENSITY BIN LIMIT ($I_f = 20 \text{ mA}$)

Cool White(C503C-WAS/WAN)

Bin Code	Min.(mcd)	Max.(mcd)
Ba	16800	20150
Bb	20150	23500
Ca	23500	28200
Cb	28200	32900
Da	32900	39500
Db	39500	46100

- Tolerance of measurement of luminous intensity is $\pm 15\%$

VF BIN LIMIT ($I_f = 20 \text{ mA}$)

Cool White(C503C-WAS/WAN)

Bin Code	Min.(V)	Max.(V)
27	2.8	3.0
28	3.0	3.2
29	3.2	3.4
2a	3.4	3.6
2b	3.6	3.8
2c	3.8	4.0

- Tolerance of measurement of VF is $\pm 0.05\text{V}$.

COLOR BIN LIMIT ($I_f = 20 \text{ mA}$)

Bin Code	Sub-bin	x	y
W1	Wa	0.2545	0.2480
		0.2633	0.2410
		0.2545	0.2245
		0.2450	0.2290
	Wb	0.2633	0.2410
		0.2720	0.2340
		0.2640	0.2200
		0.2545	0.2245
	Wc	0.2545	0.2480
		0.2640	0.2670
		0.2720	0.2575
		0.2633	0.2410
	Wd	0.2633	0.2410
		0.2720	0.2575
		0.2800	0.2480
		0.2720	0.2340
W2	We	0.2640	0.2670
		0.2735	0.2860
		0.2808	0.2740
		0.2720	0.2575
	Wf	0.2720	0.2575
		0.2808	0.2740
		0.2880	0.2620
		0.2800	0.2480
	Wg	0.2735	0.2860
		0.2830	0.3050
		0.2895	0.2905
		0.2808	0.2740
	Wh	0.2808	0.2740
		0.2895	0.2905
		0.2960	0.2760
		0.2880	0.2620

Bin Code	Sub-bin	x	y
W3	Wj	0.2830	0.3050
		0.2950	0.3210
		0.2998	0.3028
		0.2895	0.2905
	Wk	0.2895	0.2905
		0.2998	0.3028
		0.3045	0.2865
		0.2960	0.2760
	Wm	0.2950	0.3210
		0.3070	0.3370
		0.3100	0.3150
		0.2998	0.3028
	Wn	0.2998	0.3028
		0.3100	0.3150
		0.3130	0.2970
		0.3045	0.2865
W4	Wp	0.3070	0.3370
		0.3185	0.3485
		0.3200	0.3270
		0.3100	0.3150
	Wq	0.3100	0.3150
		0.3200	0.3270
		0.3215	0.3075
		0.3130	0.2970
	Wr	0.3185	0.3485
		0.3300	0.3600
		0.3300	0.3390
		0.3200	0.3270
	Ws	0.3200	0.3270
		0.3300	0.3390
		0.3300	0.3180
		0.3215	0.3075

Bin Code	Sub-bin	x	y
W5	Wt	0.3300	0.3600
		0.3455	0.3725
		0.3443	0.3535
		0.3300	0.3390
	Wu	0.3300	0.3390
		0.3443	0.3535
		0.3430	0.3345
		0.3300	0.3180
	Wv	0.3455	0.3725
		0.3610	0.3850
		0.3585	0.3680
		0.3443	0.3535
	Ww	0.3443	0.3535
		0.3585	0.3680
		0.3560	0.3510
		0.3430	0.3345

• Tolerance of measurement of the color coordinates is ± 0.01 .

CIE CHROMATICITY DIAGRAM

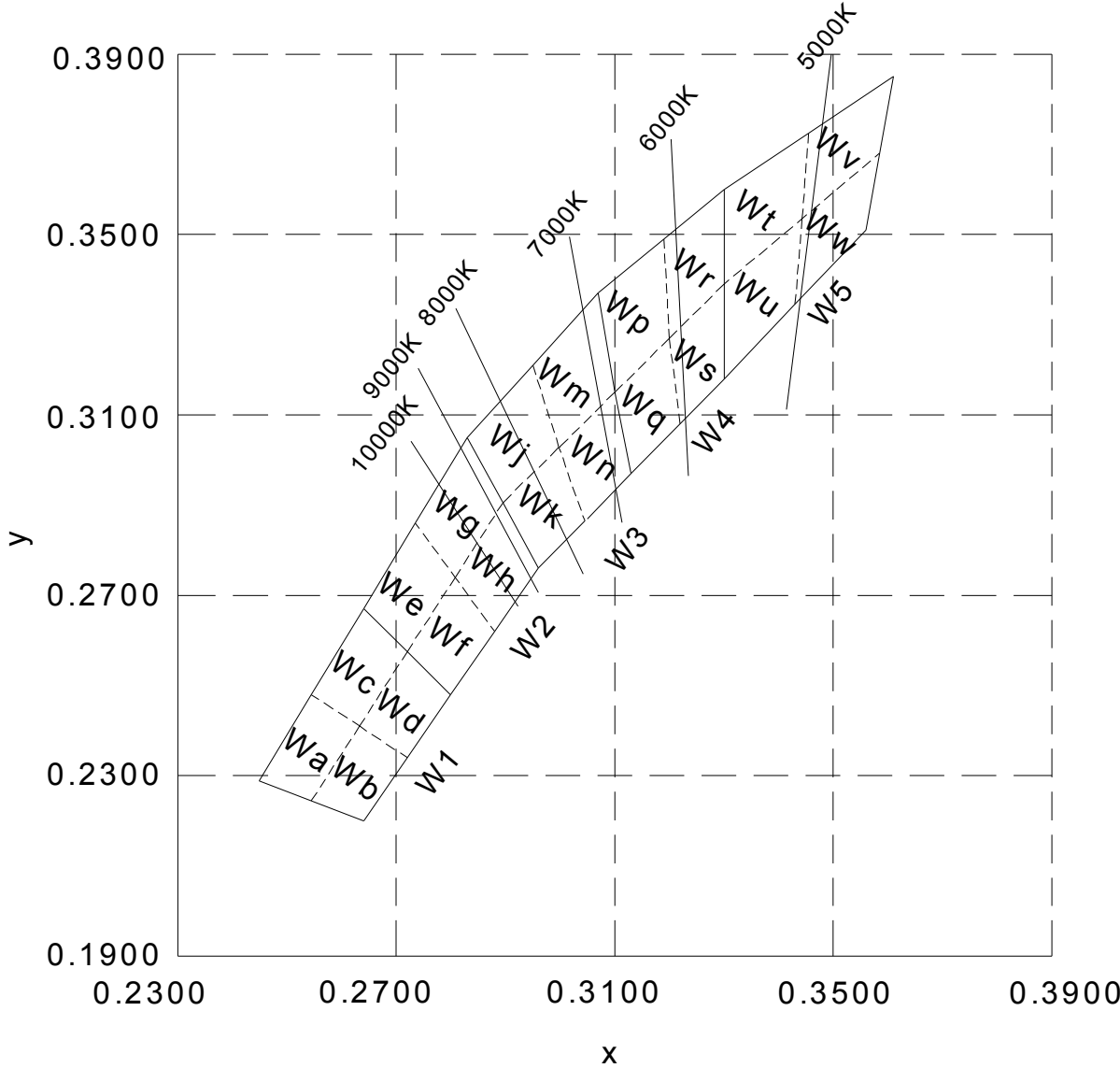

ORDER CODE TABLE*

Color	Kit Number	Viewing Angle	Luminous Intensity (mcd)		Color Bin Code	Package	Standoff
			Min.	Max.			
Cool White	C503C-WAS-CBaDb151	15	16800	46100	W1,W2,W3,W4,W5	Bulk	Yes
Cool White	C503C-WAS-CBbDb151	15	20150	46100	W1,W2,W3,W4,W5	Bulk	Yes
Cool White	C503C-WAS-CBbDb231	15	20150	46100	W2,W3	Bulk	Yes
Cool White	C503C-WAS-CCaDb231	15	23500	46100	W2,W3	Bulk	Yes
Cool White	C503C-WAN-CBaDb151	15	16800	46100	W1,W2,W3,W4,W5	Bulk	No
Cool White	C503C-WAN-CBbDb151	15	20150	46100	W1,W2,W3,W4,W5	Bulk	No
Cool White	C503C-WAN-CBbDb231	15	20150	46100	W2,W3	Bulk	No
Cool White	C503C-WAN-CCaDb231	15	23500	46100	W2,W3	Bulk	No
Cool White	C503C-WAS-CBaDb152	15	16800	46100	W1,W2,W3,W4,W5	Ammo	Yes
Cool White	C503C-WAS-CBbDb152	15	20150	46100	W1,W2,W3,W4,W5	Ammo	Yes
Cool White	C503C-WAS-CBbDb232	15	20150	46100	W2,W3	Ammo	Yes
Cool White	C503C-WAS-CCaDb232	15	23500	46100	W2,W3	Ammo	Yes
Cool White	C503C-WAN-CBaDb152	15	16800	46100	W1,W2,W3,W4,W5	Ammo	No
Cool White	C503C-WAN-CBbDb152	15	20150	46100	W1,W2,W3,W4,W5	Ammo	No
Cool White	C503C-WAN-CBbDb232	15	20150	46100	W2,W3	Ammo	No
Cool White	C503C-WAN-CCaDb232	15	23500	46100	W2,W3	Ammo	No

Notes:

1. The above kit numbers represent order codes that include multiple intensity-bin and color-bin codes. Only one intensity-bin code and one color-bin code will be shipped on each bulk. Single intensity-bin code and single color-bin codes will not be orderable.
2. Please refer to the "Cree LED Lamp Reliability Test Standards" document for reliability test conditions.
3. Please refer to the "Cree LED Lamp Soldering & Handling" document for information about how to use this LED product safely.

GRAPHS

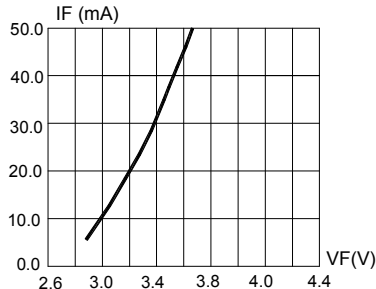

FIG.1 FORWARD CURRENT VS. FORWARD VOLTAGE.

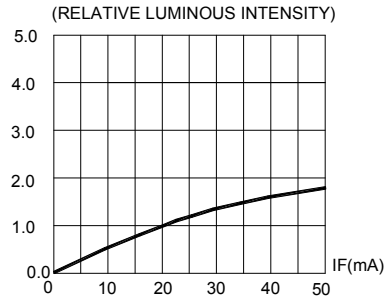

FIG.2 RELATIVE LUMINOUS INTENSITY VS. FORWARD CURRENT

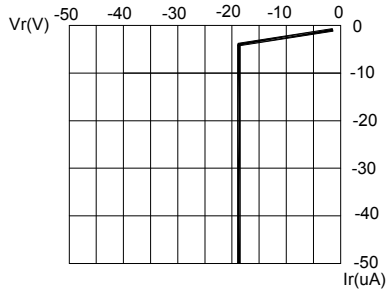

FIG.3 REVERSE CURRENT VS. REVERSE VOLTAGE.

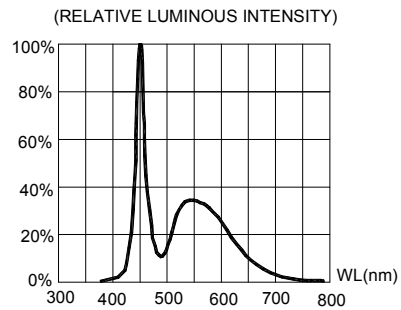

FIG.4 RELATIVE LUMINOUS INTENSITY VS. WAVELENGTH.

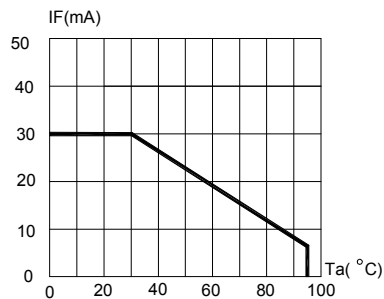

FIG.5 MAXIMUM FORWARD DC CURRENT VS AMBIENT TEMPERATURE (Tjmax=105°C)

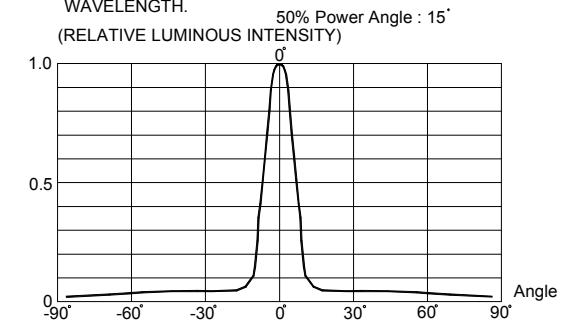

FIG.6 FAR FIELD PATTERN

The above data are collected from statistical figures that do not necessarily correspond to the actual parameters of each single LED. Hence, these data will be changed without further notice.

MECHANICAL DIMENSIONS

All dimensions are in mm. Tolerance is ± 0.25 mm unless otherwise noted.

An epoxy meniscus may extend about 1.5 mm down the leads.

Burr around bottom of epoxy may be 0.5 mm max.

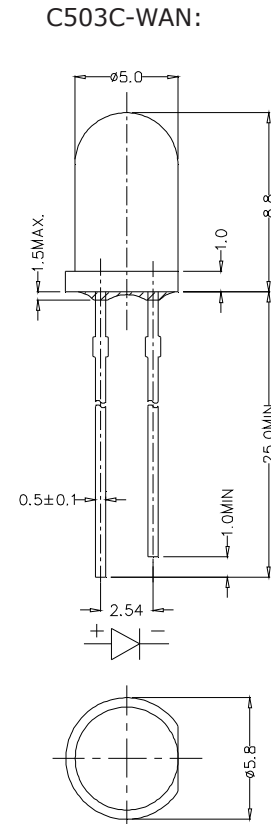
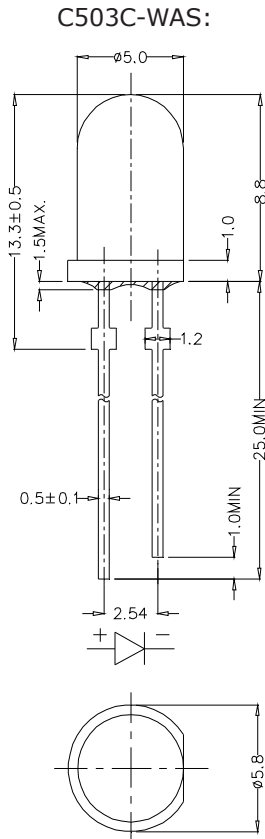

NOTES

RoHS Compliance

The levels of environmentally sensitive, persistent biologically toxic (PBT), persistent organic pollutants (POP), or otherwise restricted materials in this product are below the maximum concentration values (also referred to as the threshold limits) permitted for such substances, or are used in an exempted application, in accordance with EU Directive 2002/95/EC on the restriction of the use of certain hazardous substances in electrical and electronic equipment (RoHS), as amended through April 21, 2006.

Vision Advisory Claim

Users should be cautioned not to stare at the light of this LED product. The bright light can damage the eye.

KIT NUMBER SYSTEM

All dimensions in mm. Cree LED lamps are tested and sorted into performance bins. A bin is specified by ranges of color, forward voltage, and brightness. Sorted LEDs are packaged for shipping in various convenient options. Please refer to the "Cree LED Lamp Packaging Standard" document for more information about shipping and packaging options.

Cree LEDs are sold by order codes in combinations of bins called kits. Order codes are configured in the following manner:



PACKAGING

Features:

- The LEDs are packed in cardboard boxes after packaging in normal or anti-electrostatic bags.
- Cardboard boxes will be used to protect the LEDs from mechanical shock during transportation.
- The boxes are not water resistant, and they must be kept away from water and moisture.
- The Bulk Pack types of packaging.
- Max 500 pcs per bulk and Max 2500 pcs per ammo.

Bulk Pack Packaging Type:

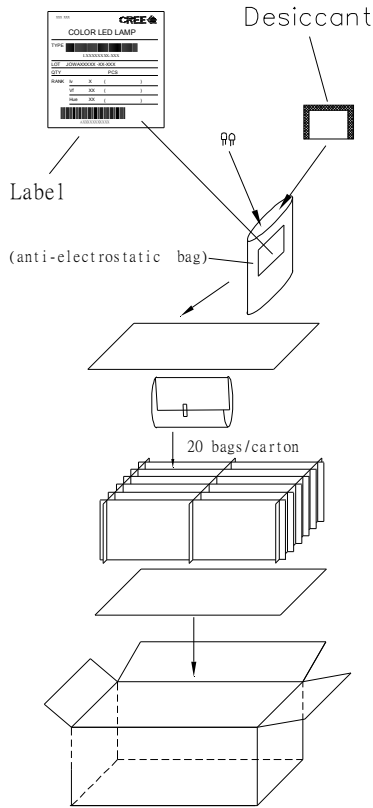

Ammo Pack Packaging Type:

