

**PART NUMBER:** EPA120100-P5-SZ**DESCRIPTION:** linear adapter**SPECIFICATIONS**

output voltage	12 V ac at 1000 mA	
rated input voltage	120 V ac	
primary rated voltage	120 V ac 60 Hz 17 W	
primary exciting current	30 mA rms max.	
secondary rated voltage & current	no load voltage (max.)	15.6 V
	full load voltage (1000 mA)	12 V \pm 5%
temperature rise of primary winding (full load)	70°C max. using resistance method	
insulation resistance	\geq 100 M Ohm at 500 Vdc	
HI-POT test	primary to secondary	1240 V ac at 2 mA for 1 minute
	primary to secondary	1600 V ac at 2 mA for 1 second
	primary winding to secondary winding	1600 V ac at 2 mA for 1 second
	primary winding to core	1600 V ac at 2 mA for 1 second
	secondary winding to core	750 V ac at 2 mA for 1 second
safety standard	UL/cUL	
weight	388 g	
RoHS compliant	yes	
test conditions	ambient temp	40 \pm 2°C
	humidity	90~95% 96 hours at Full Load
adapter color	case	black
	cord	black



PART NUMBER: EPA120100-P5-SZ

DESCRIPTION: linear adapter

LABEL

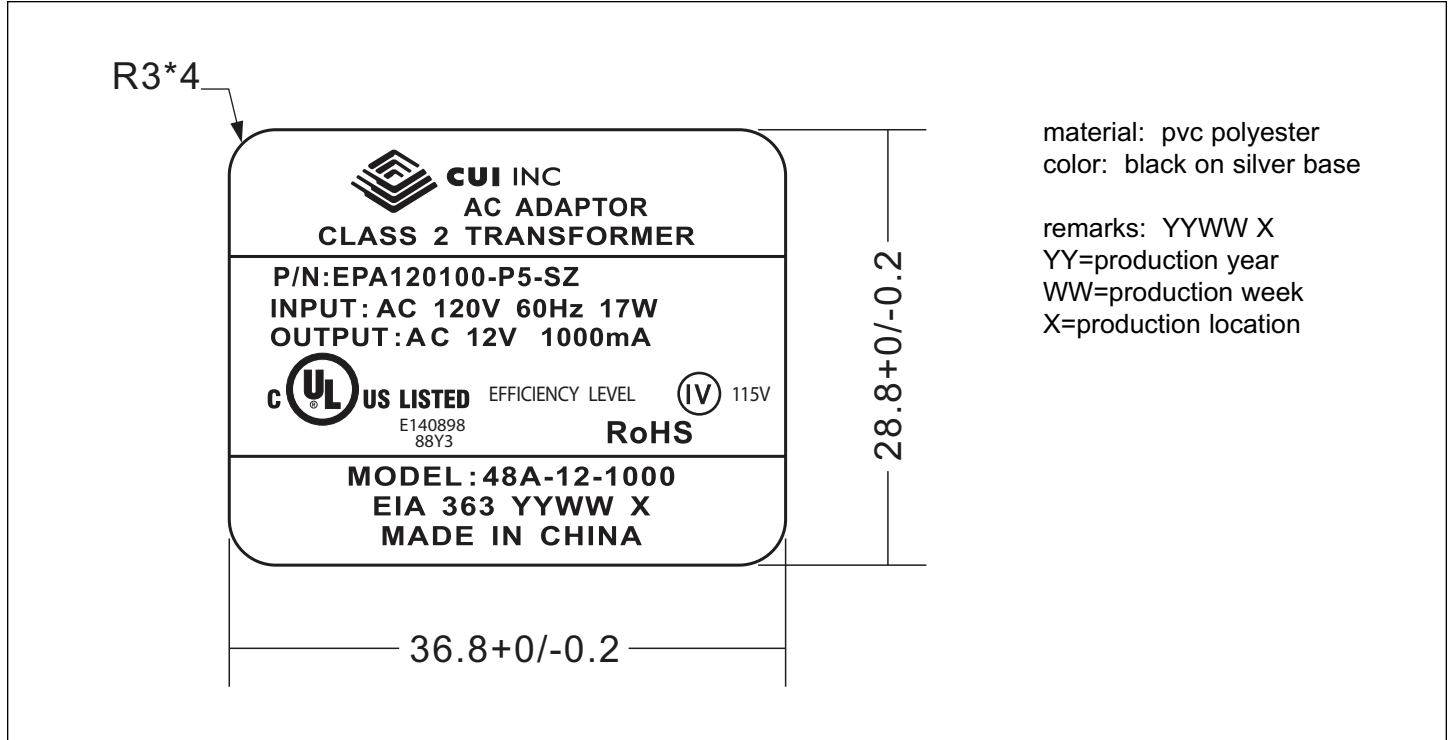

PART NUMBER: EPA120100-P5-SZ

DESCRIPTION: linear adapter

CIRCUIT DIAGRAM

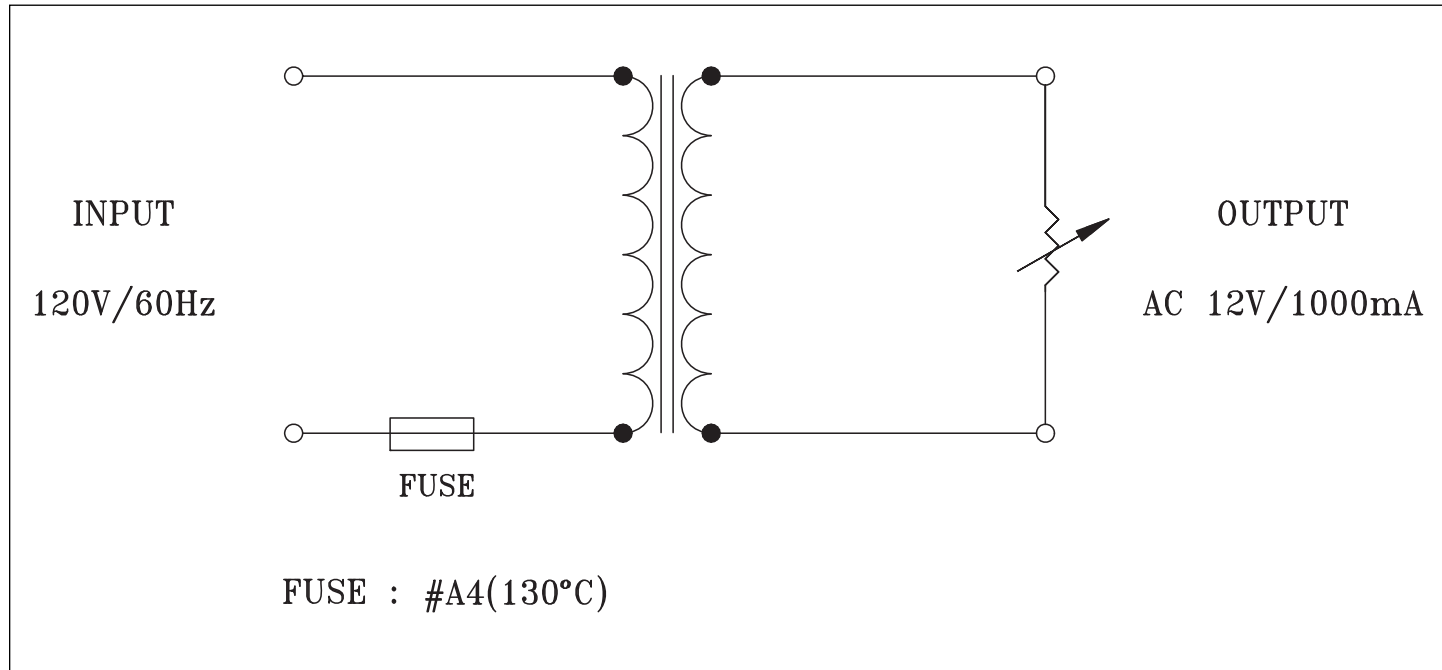

TEST CIRCUIT

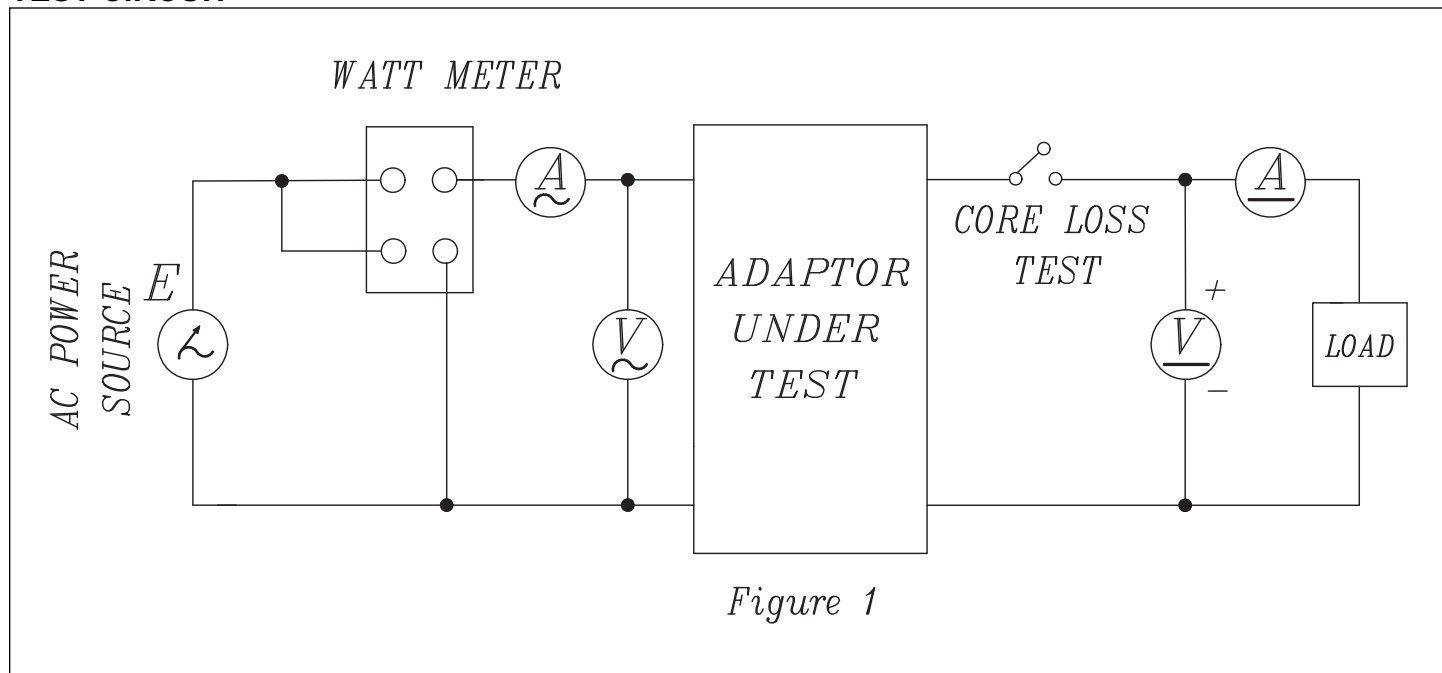

PART NUMBER: EPA120100-P5-SZ

DESCRIPTION: linear adapter

MECHANICAL DRAWING

tolerance	±1mm
weight	388 g

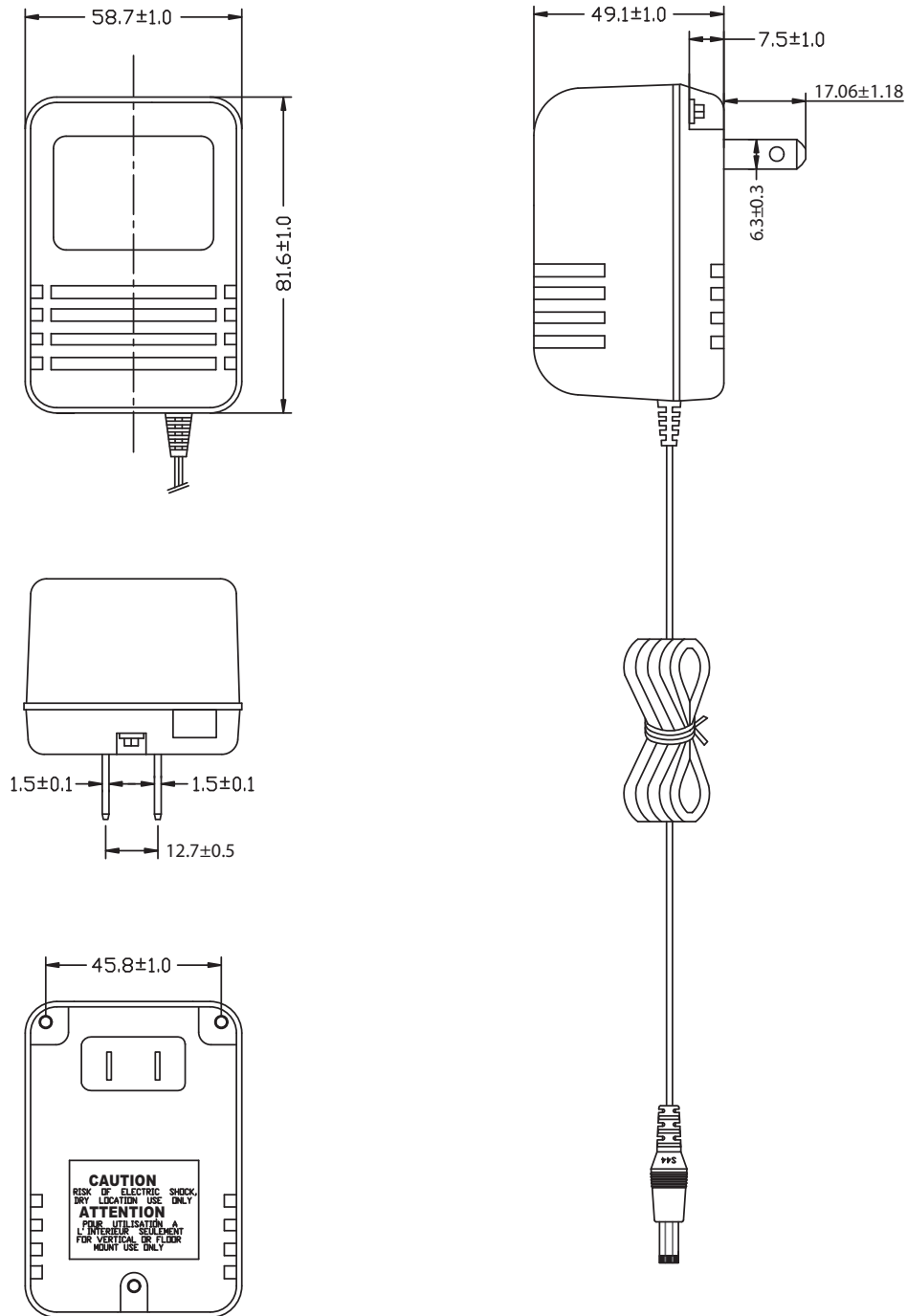

PART NUMBER: EPA120100-P5-SZ

DESCRIPTION: linear adapter

DC CORD

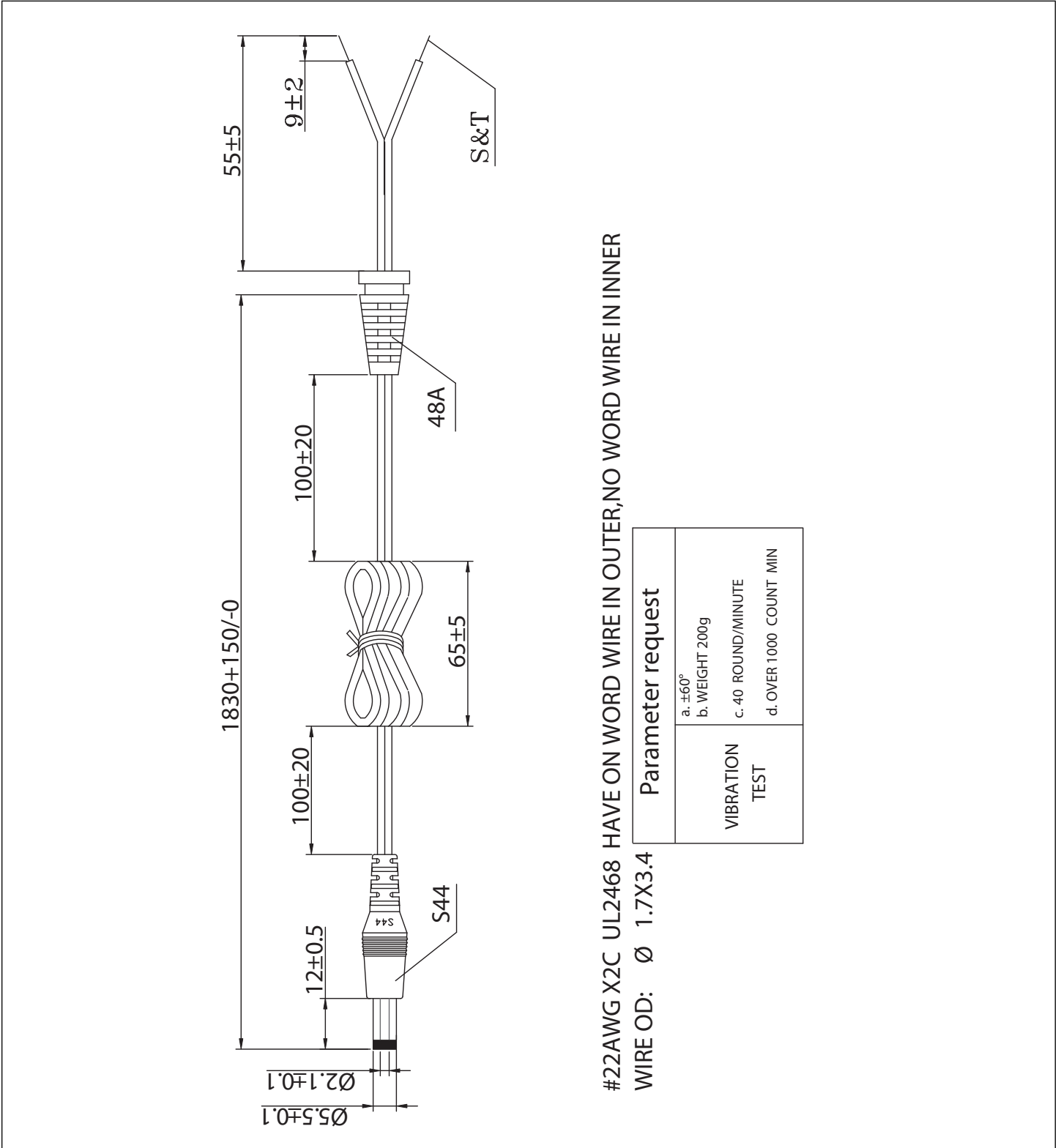

PART NUMBER: EPA120100-P5-SZ

DESCRIPTION: linear adapter

INDIVIDUAL PACKAGING

tolerance: ± 1

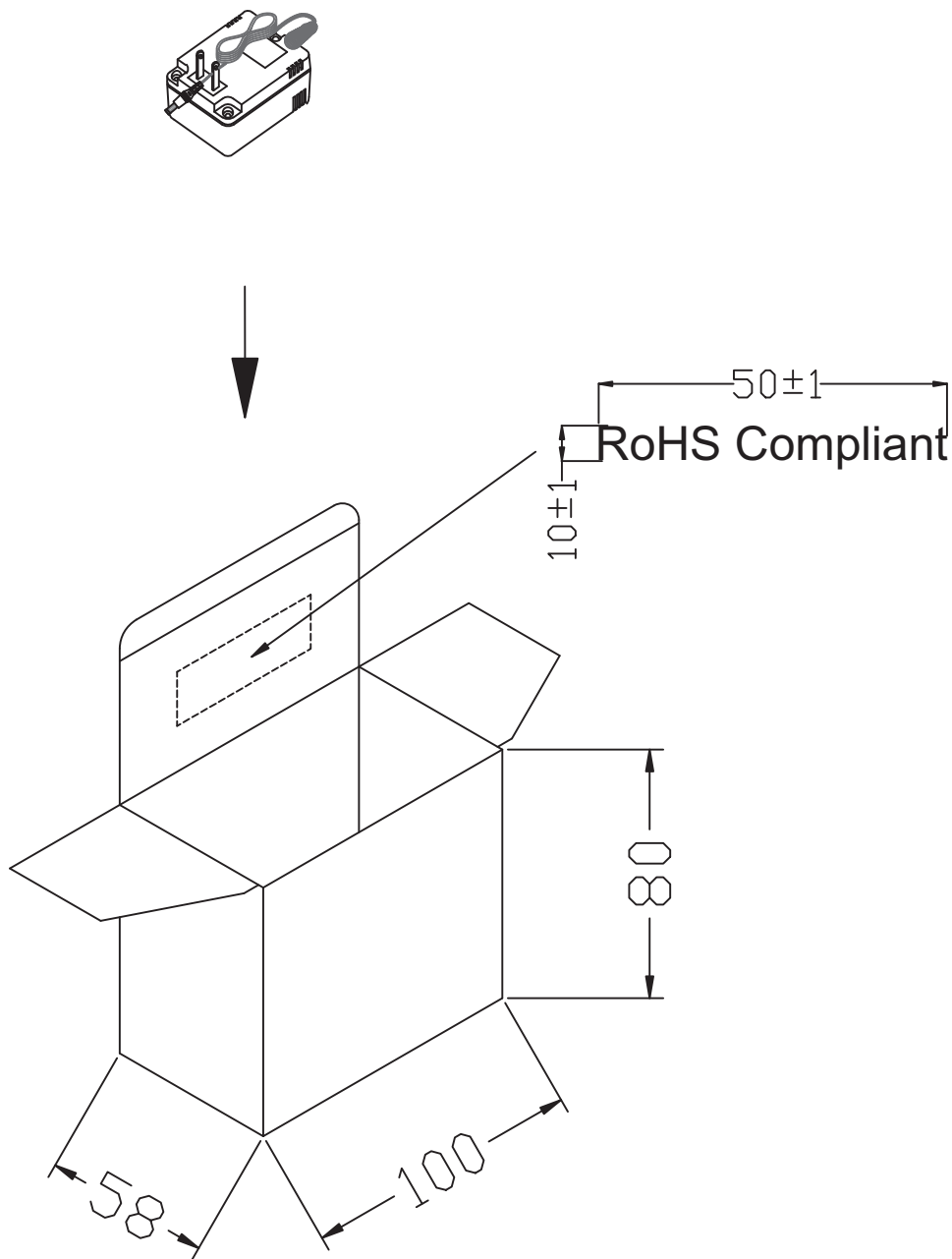

PART NUMBER: EPA120100-P5-SZ

DESCRIPTION: linear adapter

PACKAGING

tolerance: +7/-0

OUTSIDE CARTON:A=B(6mm)
INSIDE CARTON:B3B(3mm)
CARTON SIZE: 430x223x269mm
Q'TY: 40pcs(10X4X1)

