

The products listed in this catalog are only a few of the thousands of variations that TUSONIX produces. For custom applications, please contact the factory direct.

TUSONIX Capabilities

TUSONIX, Inc. manufactures thousands of EMC Products and features an extensive line of EMI/RFI Filters and Capacitors. We combine Technology, Expertise, Versatility and Innovation to produce the industry's most complete line of ceramic EMI/RFI Filters. TUSONIX draws upon its 50 plus years of manufacturing expertise and an accumulated base of ceramic dielectric technology to provide an ever expanding line of EMI/RFI Filters and Capacitors. These products not only set the industry standard, but lead the way in the development of tomorrow's EMI Technology.



TUSONIX Quality

The Tusonix Quality Management System assures complete customer satisfaction. A fully equipped and approved Quality and Reliability Assurance Laboratory continually monitors product design and manufacturing integrity through its periodic Conformance Test Program. Tusonix also requires MIL testing for those products approved to MIL-PRF-81, MIL-C-11015 and MIL-PRF-15733.

Manufacturing

Utilizing more than 120,000 square feet (11,150 square meters) of manufacturing, TUSONIX is dedicated to providing high quality EMI/RFI products.

In addition to the standard catalog items, TUSONIX has numerous variations of these designs and can custom design a part to meet particular specifications. TUSONIX maintains a staff of highly skilled Design Engineers to assist its customers in the design of custom products.

Meeting Customer Requirements

Headquartered in Tucson, Arizona, TUSONIX is devoted to bringing the company's broad product line to an ever expanding world market. TUSONIX has more than five decades of manufacturing experience and uses sophisticated equipment to provide customers full value for the products they purchase at competitive prices.

Contents of the Short-Form Catalog

Surface Mount Filters	Pg. 2
Solder Mount Pi Filters	Pg. 2
Miniature Solder Mount Filters	Pg. 3
Miniature Bushing Mount Filters	Pg. 3
8-32 and 12-28 Thread Filters	Pg. 4
12-32 and 5/16-32 Thread Filters	Pg. 5
Metric Thread Filters	Pg. 5
Coaxial Broadband Filters	Pg. 6
Filtered Terminal Blocks	Pg. 6
Trimmer Capacitors	Pg. 7
Ceramic Disc/WEECON® Capacitors	Pg. 8
Filter Plate Selector Guide	Pg. 9
Part Number Index	Pg. 10
Mil Filter Cross Reference	Pg. 10

Circuits Available from TUSONIX

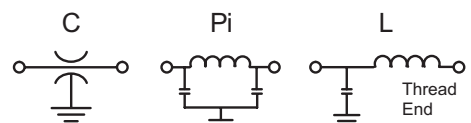

4700 Series Surface Mount EMI Pi Filter

www.tusonix.com Download Catalog 4700 (.pdf format)

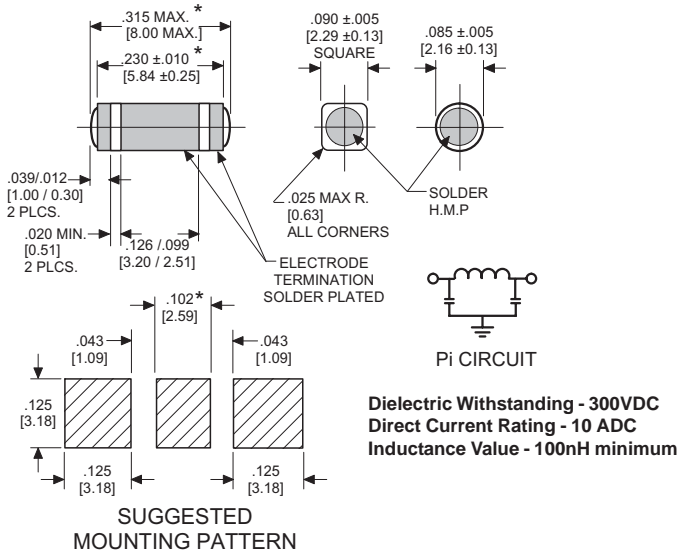

Part No.	WVDC		Cap. (pF)	Cap. Tol.	Typical No Load Insertion Loss dB @ 25°C per MIL-STD-220		
	85°C	125°C			10MHz	100MHz	1GHz
Square Filter							
4700-006	100	100	100	+80-20%	--	3	16
4700-009	100	100	470	+80-20%	1	16	40
4700-005	100	100	1000	GMV	7	40	65
4700-003	100	100	2000	GMV	10	45	70
4700-008	100	--	4000	+80-20%	13	52	70
4701-002*	100	--	6800	+80-20%	16	60	70
4701-001*	100	--	8200	+80-20%	20	65	70
Round Filter							
4700-059	100	100	100	+80-20%	--	3	16
4700-058	100	100	1000	GMV	7	40	65
4700-053	100	100	2000	GMV	10	45	70
4700-056	100	--	5000	+80-20%	15	55	70

Additional Capacitance Values and Mounting Patterns are available upon request. Please contact our Customer Engineering Department at (520) 744-0400. Packaging is tape and reeled on a 16.00 mm tape.

* 4701 variation has a body length of .336 ± .010 [8.53 ± 0.25] and a MAX. overall length of .394 [10] and .202 [5.13] length for the center rectangle of the mounting configuration. All other part dimensions are as shown.

Reference Engineers Sample Kit # SK4700-900

GMV = Guaranteed Minimum Value

Solder Mount EMI Pi Filters

www.tusonix.com Download Catalog 4000 (.pdf format)

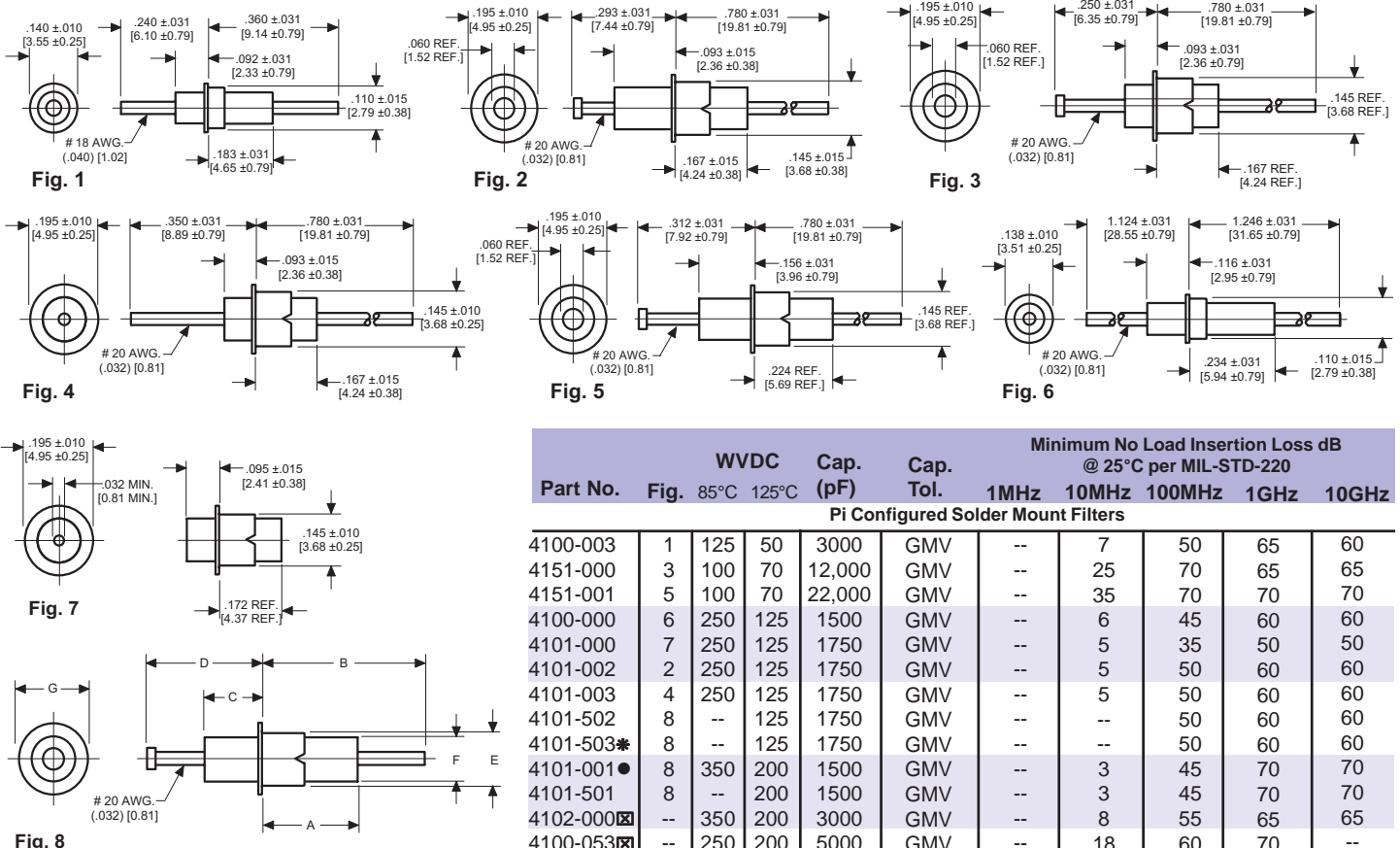

Part No.	Fig.	WVDC		Cap. (pF)	Cap. Tol.	Minimum No Load Insertion Loss dB @ 25°C per MIL-STD-220			
		85°C	125°C			1MHz	10MHz	100MHz	1GHz

Pi Configured Solder Mount Filters										
4100-003	1	125	50	3000	GMV	--	7	50	65	60
4151-000	3	100	70	12,000	GMV	--	25	70	65	65
4151-001	5	100	70	22,000	GMV	--	35	70	70	70
4100-000	6	250	125	1500	GMV	--	6	45	60	60
4101-000	7	250	125	1750	GMV	--	5	35	50	50
4101-002	2	250	125	1750	GMV	--	5	50	60	60
4101-003	4	250	125	1750	GMV	--	5	50	60	60
4101-502	8	--	125	1750	GMV	--	--	50	60	60
4101-503*	8	--	125	1750	GMV	--	--	50	60	60
4101-001●	8	350	200	1500	GMV	--	3	45	70	70
4101-501	8	--	200	1500	GMV	--	3	45	70	70
4102-000☒	--	350	200	3000	GMV	--	8	55	65	65
4100-053☒	--	250	200	5000	GMV	--	18	60	70	--

Mil-PRF-15733	Fig.	Part No.	DIM. A	DIM. B	DIM. C	DIM. D	DIM. E	DIM. F	DIM. G
/33-0001	8	4101-502	.170 ±.027	.780 ±.031	.093 ±.015	.288 ±.015	---	.125 MAX	.190 ±.015
/33-0002*	8	4101-503	[4.32 ± 0.69]	[19.81 ± 0.79]	[2.36 ± 0.38]	[7.32 ± 0.38]		[3.18 MAX]	[4.83 ± 0.38]
/62-0001	8	4101-501	[6.35 ± 0.79]	[10.31 ± 0.79]	[3.96 ± 0.79]	[7.92 ± 0.79]	[3.68 ± 0.38]	[3.18 ± 0.38]	[4.83 ± 0.38]

* Mil Part number /33-0002 has a straight lead
● Same dimensions as /62-0001
☒ Diagram not available

Reference Engineers Sample Kit # SK4000-900

The products listed in this catalog are only a few of the thousands of variations that TUSONIX produces. For custom applications, please contact the factory direct.

Miniature EMI Filters

4300 Series Miniature EMI Filter

www.tusonix.com Download Catalog 4000 (.pdf format)

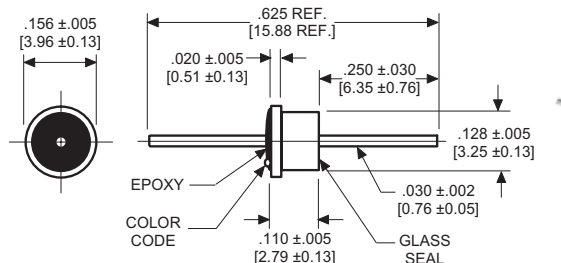

Epoxy Sealed Top (flange)/ Glass Sealed Bottom

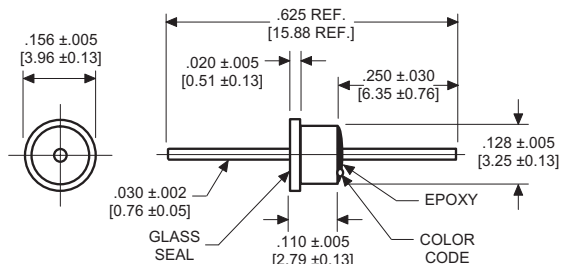

Glass Sealed Top (flange)/ Epoxy Sealed Bottom

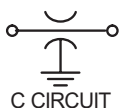

Please Note: TUSONIX can also supply the 4302 Series, which is epoxy sealed at both ends. Please consult our Customer Engineering Department at (520) 744-0400.

Reference Engineers Sample Kit # SK4000-903

TUSONIX 4300 Series Miniature EMI Filters are ideal for applications where small size and high performance are critical. These C configured filters can be glass sealed on either one of the ends for optimal sealing between system compartments or components. The gold plating on the leads offers excellent conductivity and connective ability using common gold bonding methods. The small package and large range of electrical characteristics of the 4300 Series make it an effective solution for a variety of micro-wave applications.

Part No.	WVDC		Cap. (pF)	Cap. Tol.	Minimum No Load Insertion Loss dB @ 25°C per MIL-STD-220				
	85°C	125°C			1MHz	10MHz	100MHz	1GHz	10GHz
Epoxy Sealed Top (flange)/ Glass Sealed Bottom									
4300-006	70	50	15,000	GMV	7	20	35	55	60
4300-003	150	100	2700	GMV	--	10	25	40	50
4300-004	150	100	5000	GMV	--	15	30	45	55
4300-680	300	200	5	MAX	--	--	--	--	--
4300-000	300	200	100	GMV	--	--	3	20	28
4300-001	300	200	500	GMV	--	--	15	35	40
4300-002	300	200	1200	GMV	--	5	20	35	45
Glass Sealed Top (flange)/ Epoxy Sealed Bottom									
4300-023	150	100	2700	GMV	--	10	25	40	50
4300-024	150	100	5000	GMV	--	15	30	45	55
4300-681	300	200	5	MAX	--	--	--	--	--
4300-020	300	200	100	GMV	--	--	3	20	28
4300-021	300	200	500	GMV	--	--	15	35	40
4300-022	300	200	1200	GMV	--	5	20	35	45

GMV = Guaranteed Minimum Value

4400 Series Miniature EMI Bushing Mount Filter

www.tusonix.com Download Catalog 4000 (.pdf format)

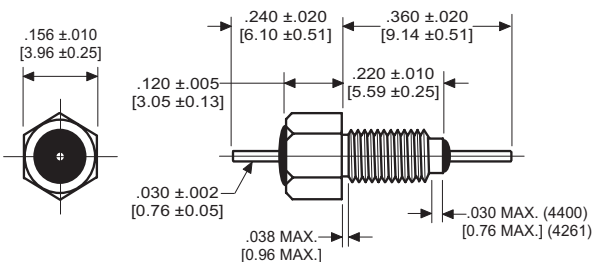

4- 40 UNC - 2A Thread Standard Bushing

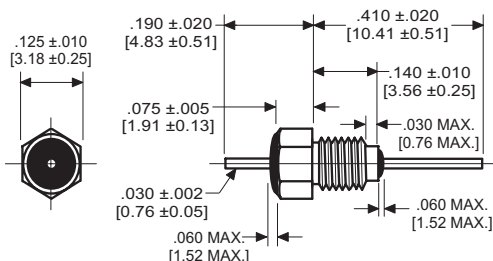

4- 40 UNC - 2A Thread Miniature Bushing

- *.020 [.51] diameter leads
- .018 [.46] diameter leads

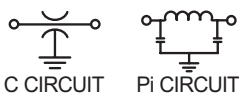

Please Note: TUSONIX also produces many of the variations above in an L Circuit. Please contact our Customer Engineering Department at (520) 744-0400.

Reference Sample Kit # SK4000-903

TUSONIX 4400 Series Miniature EMI Filters are ideal for applications where small size and high performance are critical and a threaded mounting technique is desired. These C and L configured filters are available in two physical configurations and can be supplied with either unified or metric thread (see page 5 for metric.) The small package and large range of electrical characteristics of the 4400 Series make it an effective solution for a variety of micro-wave applications.

Part No.	WVDC		Cap. (pF)	Cap. Tol.	Minimum No Load Insertion Loss dB @ 25°C per MIL-STD-220				
	85°C	125°C			1MHz	10MHz	100MHz	1GHz	10GHz
#4-40 UNC-2A Thread Standard Bushing, C Configuration									
4400-016*	50	50	50,000	GMV	15	35	45	70	--
4400-033	150	100	2700	GMV	--	10	25	40	50
4400-034	150	100	5000	GMV	--	15	30	45	55
4400-030	300	200	100	GMV	--	--	3	20	28
4400-031	300	200	500	GMV	--	--	15	35	40
4400-037	300	200	1000	GMV	--	5	20	35	45
4400-032	300	200	1200	GMV	--	5	20	35	45
#4-40 UNC-2A Miniature Bushing, C Configuration									
4403-033	150	100	2700	GMV	--	10	25	40	50
4403-034	150	100	5000	GMV	--	15	30	45	55
4403-030	300	200	100	GMV	--	--	3	20	28
4403-031	300	200	500	GMV	--	--	15	35	40
4403-037	300	200	1000	GMV	--	5	20	35	45
4403-032	300	200	1200	GMV	--	5	20	35	45
#4-40 UNC-2A Thread Pi Configuration									
4261-001■	--	50	5,500	GMV	--	14	55	70	--

#8-32 Thread Bushing Mount Filters

www.tusonix.com Download Catalog 4000 (.pdf format)

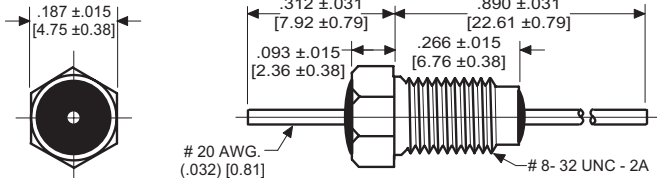

Fig. 1

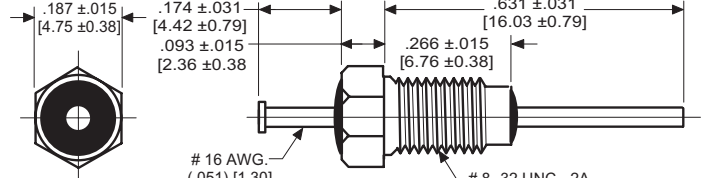

Fig. 2

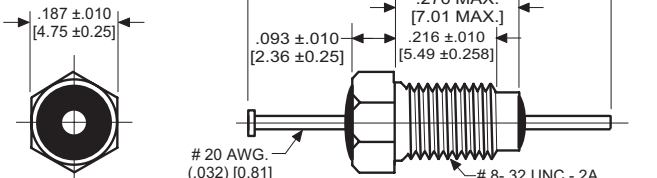

Fig. 3

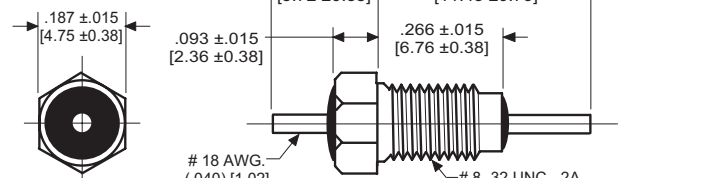

Fig. 4

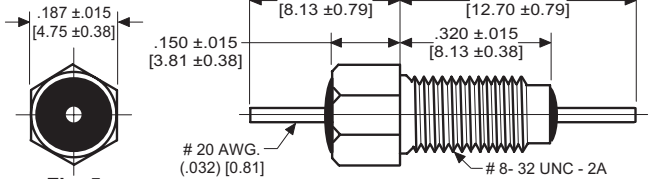

Fig. 5

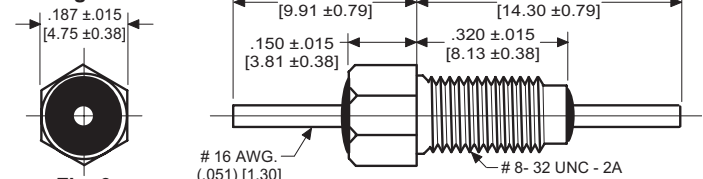

Fig. 6

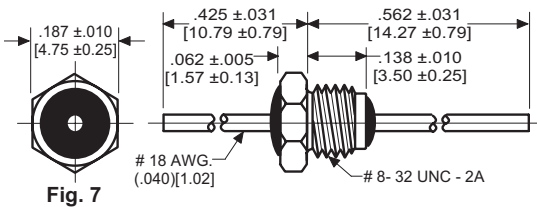

Fig. 7

Part No.	Fig.	WVDC		Cap. (pF)	Cap. Tol.	Minimum No Load Insertion Loss dB @ 25°C per MIL-STD-220				
		85°C	125°C			1MHz	10MHz	100MHz	1GHz	10GHz
#8-32 UNC-2A Thread Pi Configuration										
4251-004	5	100	100	28,000	GMV	10	38	75	75	75
4251-000	4	185	125	3000	+100-0%	--	10	30	65	65
4201-502	3	--	100	1000	GMV	--	--	65	70	70
4201-000	1	200	100	1500	GMV	--	5	45	65	70
4201-001	1	200	100	1500	GMV	--	5	45	65	70
4201-501	1	--	100	2500	GMV	--	--	45	60	60
4201-050	1	200	100	5500	GMV	--	14	55	70	70
4201-051	1	200	100	5500	GMV	--	14	55	70	70
4201-053	1	200	100	5500	GMV	--	14	55	65	65
4205-001	7	250	125	1500	GMV	--	5	35	60	60
#8-32 UNC-2A Thread C Configuration										
2425-018-X5U0-102P*	2	200	100	1000	+100-0%	--	3	20	35	40
2425-601-X5W0-103Z*	6	200	100	10,000	+80-20%	--	20	35	50	55

Reference Sample Kit # SK2000-900

- ◆ Turret Lead
- .18 AWG .040 [1.02] Lead
- * Insertion loss values are typical
- GMV = Guaranteed Minimum Value

12-28 Thread Feed-Through Capacitors

www.tusonix.com Download Catalog 4000 (.pdf format)

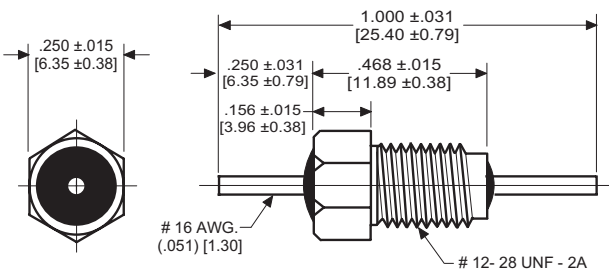

Fig. 1

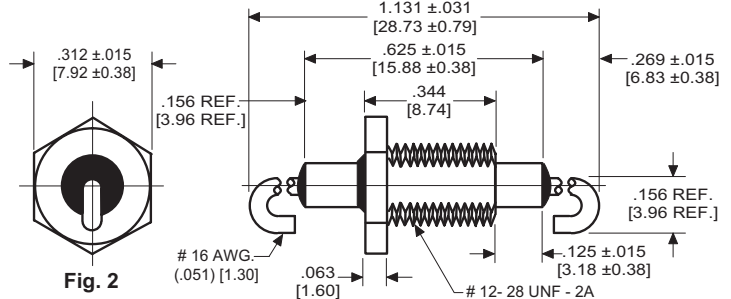

Fig. 2

Reference Sample Kit # SK2000-900 for feed-through capacitors

Part No.	Fig.	WVDC		Cap. (pF)	Cap. Tol.	Typical No Load Insertion Loss dB @ 25°C per MIL-STD-220			
		85°C	125°C			10MHz	100MHz	1GHz	10GHz
#12-28 Thread C Configuration									
2499-003-X5U0-102P	1	500	250	1000	+100-0%	3	20	35	40
2499-003-X5W0-502P	1	500	250	5000	+100-0%	15	30	45	50
2499-003-X5W0-103Z	1	500	250	10,000	+80-20%	20	35	50	55
0357-001-X5W0-103Z	2	500	250	10,000	+80-20%	20	35	50	55

The products listed in this catalog are only a few of the thousands of variations that TUSONIX produces. For custom applications, please contact the factory direct.

Bushing Mount EMI/RFI Filters

#12-32 and 5/16-32 Thread Bushing Mount Filters

www.tusonix.com Download Catalog 4000 (.pdf format)

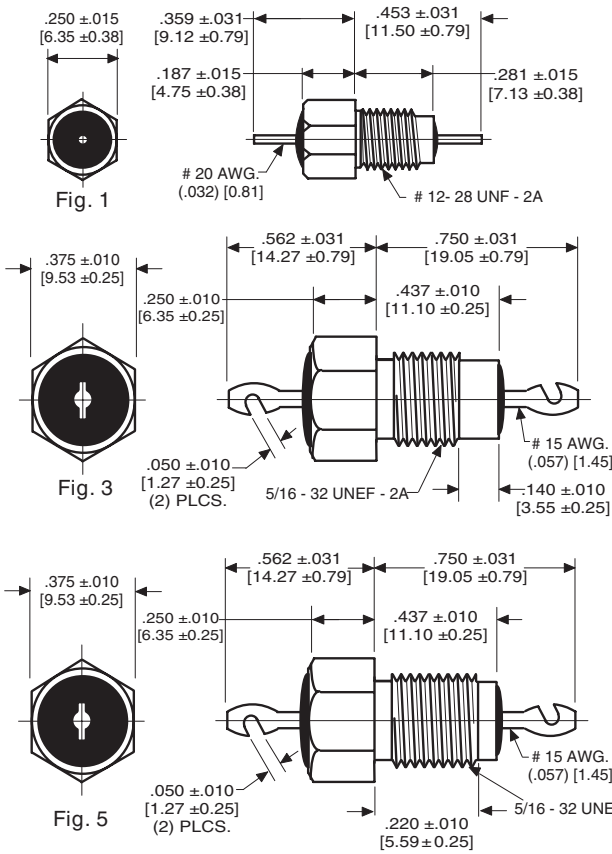

*5/16-24 UNF - 2A
Reference Sample Kit # SK4000-902

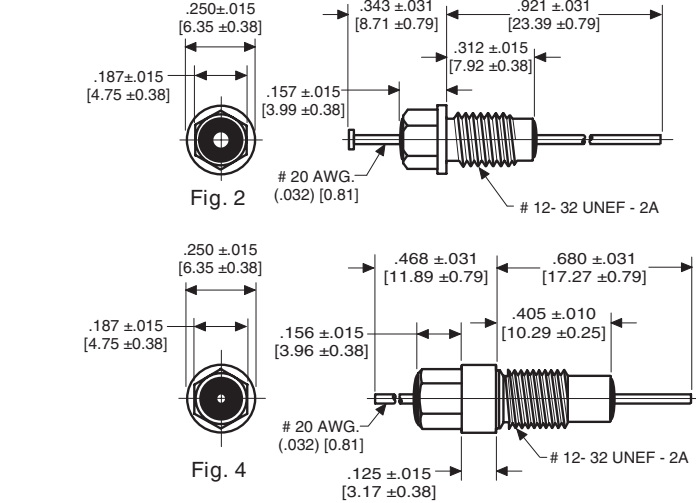

Part No.	Fig.	WVDC		Cap. (pF)	Cap. Tol.	Minimum No Load Insertion Loss dB @ 25°C per MIL-STD-220			
		85°C	125°C			1MHz	10MHz	100MHz	1GHz
#12-32 Thread Pi Configuration									
4253-002	4	100	70	50,000	GMV	15	60	75	75
4202-050	1	200	100	5000	GMV	--	20	65	70
4203-053	2	200	100	5000	GMV	--	20	65	70
4202-000	1	350	200	1500	GMV	--	5	45	70
4203-003	2	350	200	1500	GMV	--	5	45	70
4202-004	1	500	350	2500	GMV	--	5	50	70
4203-552	2	--	100	5000	GMV	--	--	65	70
5/16"-32 Thread Pi Configuration									
4206-501	3	--	500	2000	GMV	--	--	55	70
4206-502*	3	--	500	2000	GMV	--	--	55	70
4206-006	5	1000	500	3000	GMV	--	10	55	70

GMV = Guaranteed Minimum Value

Metric Bushing Filters

www.tusonix.com Download Catalog 4000 (.pdf format)

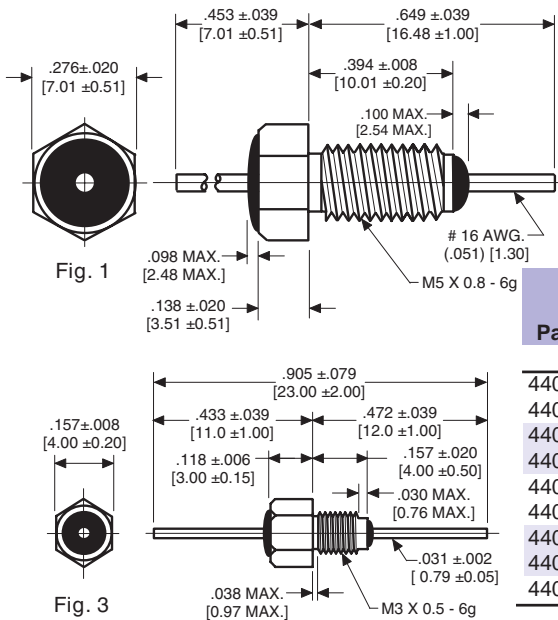

*Insertion loss values are typical.

Part No.	Fig.	WVDC		Cap. (pF)	Cap. Tol.	Minimum No Load Insertion Loss dB @ 25°C per MIL-STD-220				
		85°C	125°C			1MHz	10MHz	100MHz	1GHz	10GHz
M3 Thread C Configuration										
4400-099	3	50	50	50,000	GMV	15	35	45	70	--
4400-093	3	70	50	10,000	GMV	4	21	35	50	60
4400-098	3	70	50	27,000	GMV	10	28	42	65	65
4400-097	3	150	100	2700	GMV	--	10	25	40	50
4400-094	3	150	100	4700	GMV	--	15	30	45	55
4400-683	3	300	200	5	MAX	--	--	--	--	--
4400-076	3	300	200	100	GMV	--	--	3	20	28
4400-096	3	300	200	470	GMV	--	--	15	35	40
4400-095	3	300	200	1000	GMV	--	5	20	35	45
M5 Thread Pi Configuration										
4209-053	2	350	100	5500	GMV	--	20	65	70	70
4209-003	2	350	200	1500	GMV	--	5	45	70	70
M5 Thread C Configuration										
2499-523-Y5R0-102P*	1	500	250	1000	+100-0%	--	3	20	35	40

Coaxial Broadband Filters

www.tusonix.com Download Catalog 4000 (.pdf format)

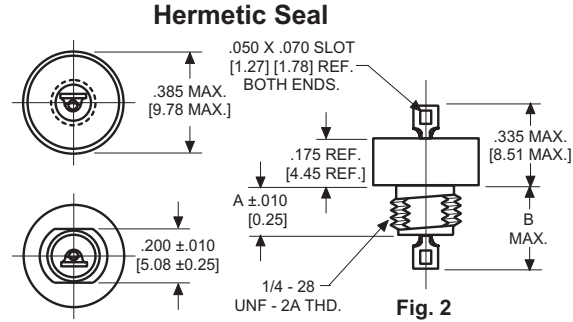
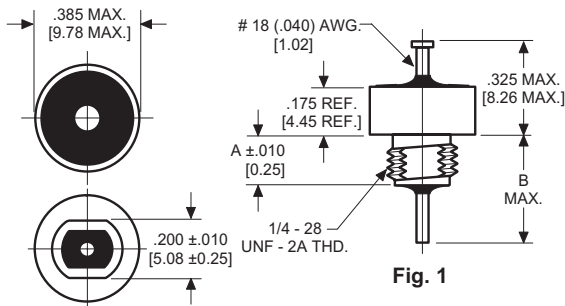

Part No.	Fig.	Dim. A	Dim. B	WVDC		Cap. (μF)	Circuit	Minimum No Load Insertion Loss dB @ 25°C per MIL-STD-220			
				85°C	125°C			30KHz	300KHz	10MHz	1GHz
Coaxial Broadband Filter C Configuration											
4600-000	1	.187 [4.75]	.367 [9.32]	100	70	1.4	C	15	34	60	70
4601-000	2	.187 [4.75]	.350 [8.89]	100	70	1.4	C	15	34	60	70
4600-003	1	.187 [4.75]	.367 [9.32]	100	50	1.4	C	15	34	60	70
Coaxial Broadband Filter L Configuration											
4600-050	1	.187 [4.75]	.367 [9.32]	100	70	1.4	L	15	34	60	70
4601-050	2	.187 [4.75]	.350 [8.89]	100	70	1.4	L	15	34	60	70
4600-053	1	.187 [4.75]	.367 [9.32]	100	50	1.4	L	15	34	60	70
4601-055	2	.187 [4.75]	.350 [8.89]	100	70	0.7	L	9	29	52	70
4600-059	1	.187 [4.75]	.367 [9.32]	280	200*	.15	L	--	15	40	60
4601-059	2	.187 [4.75]	.350 [8.89]	280	200*	.15	L	--	15	40	60

*125VAC to 400Hz; DCR - .01Ω MAX

UL Recognized Filtered Terminal Blocks

www.tusonix.com Download Catalog 7600 (.pdf format)

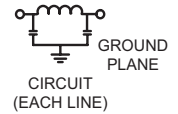
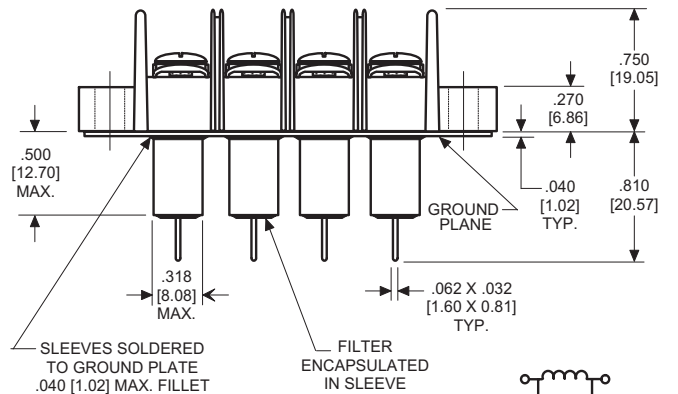
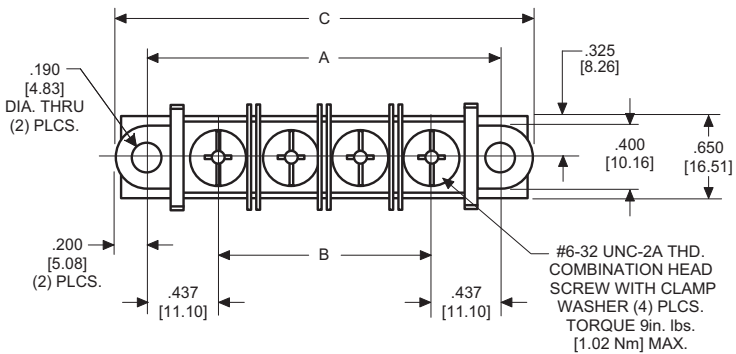

Figure 1: UL Recognized Terminal Block

EMI Filters recognized to UL Standard 1283;
Terminal Block Recognized to UL Standard 1059
(Reference UL file Number E201344.)
Operating Temperature: -40°C to +105°C
Working Voltage: 250Vac
Capacitance: 2000pF MIN.
IR: Minimum 10,000 megohms
Current Rating: 20A
DC Resistance: 10 milliohms MAX.

Part No.	Number of Leads	A	B	C
7602-501	2	1.312 [33.32]	.437 [11.10]	1.710 [43.43]
7603-501	3	1.750 [44.45]	.874 [22.20]	2.150 [54.61]
7604-501	4	2.188 [55.58]	1.311 [33.30]	2.590 [65.79]
7605-501	5	2.620 [66.68]	1.748 [44.40]	3.020 [76.71]
7606-501	6	3.063 [77.80]	2.185 [55.55]	3.460 [87.88]



The products listed in this catalog are only a few of the thousands of variations that TUSONIX produces. For custom applications, please contact the factory direct.

Variable Trimmer Capacitors

Extra Miniature Trimmer Capacitors - McQ512

www.tusonix.com Download Catalog 500 (.pdf format)

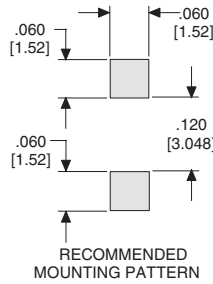
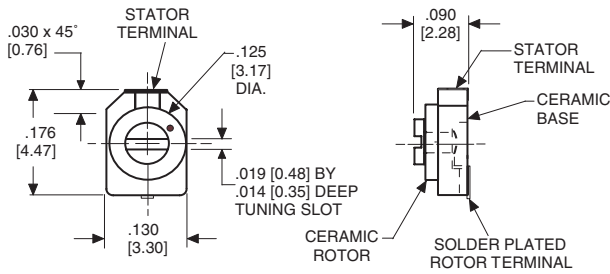

Part No.	Dielectric Type Code	Temp. COEF. PPM/°C	WVDC @125°C	Q Min.
0512-000	A	NPO ±200	100	750
0512-000	A	NPO ±200	100	750
0512-000	A	NPO ±400	100	500
0512-000	A	NPO ±400	100	500



Please contact the factory direct for capacitance ranges.

Reference Sample Kit # SK0500-900

Miniature Trimmer Capacitors

www.tusonix.com Download Catalog 500 (.pdf format)

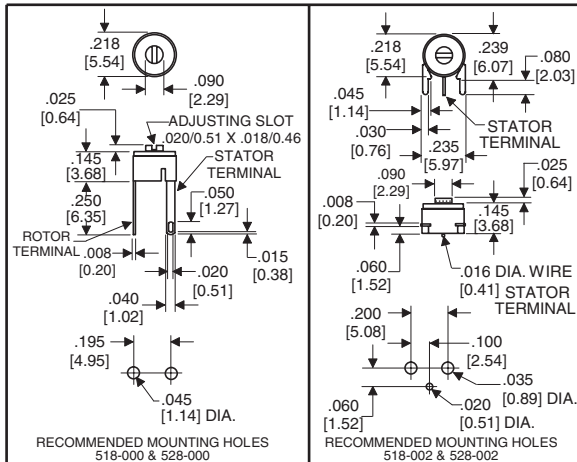

MIL-PRF-81 Designation Mil CV35 TUSONIX Style 518-016	Type Code	Cap. (pF)	TUSONIX Part Number	MIL-PRF-81 Designation Mil CV36 TUSONIX Style 518-017	Type Code	Cap. (pF)
518 Series Trimmer - 100 WVDC @85°C						
518-000	CV35A030	A 1.0-3	518-002	CV36A030	A	1.25-3
518-000	CV35A090	A 2.5-9	518-002	CV36A090	A	2.5-9
518-000	CV35A150	A 5.0-15	518-002	CV36A150	A	5.0-15

Part No.	Dielectric Type Code	Cap. (pF)	WVDC @ 125°C
528 Series Trimmer			
528-000	A	1-3	100
528-000	A	3-8	100
528-002	A	1.25-3	100
528-002	C	3.5-10	100



Miniature Trimmer Capacitors

www.tusonix.com Download Catalog 500 (.pdf format)

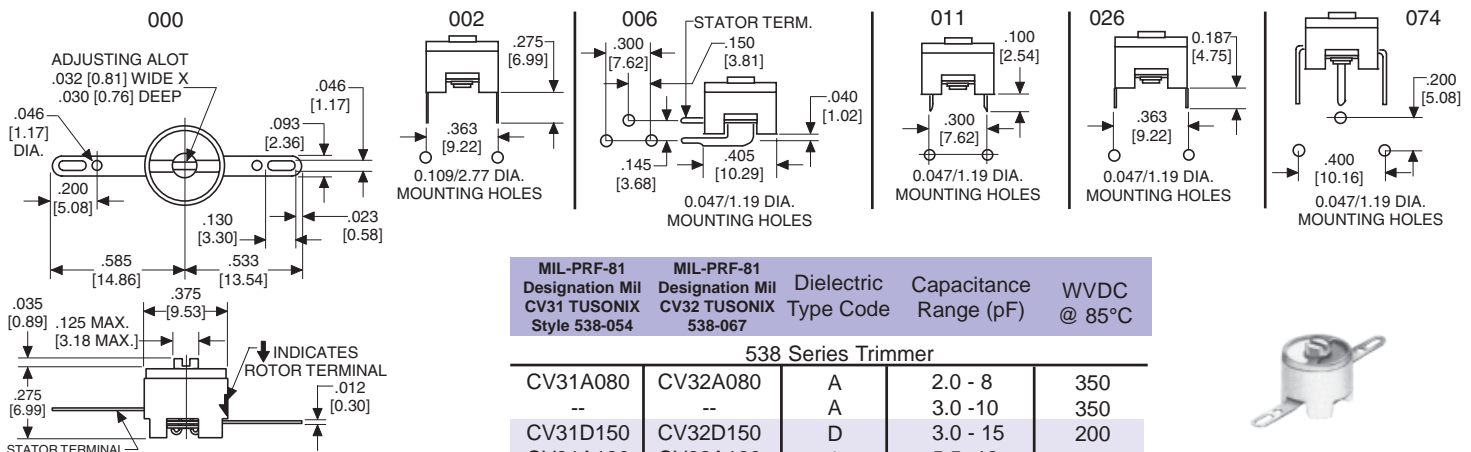

MIL-PRF-81 Designation Mil CV31 TUSONIX Style 538-054	MIL-PRF-81 Designation Mil CV32 TUSONIX Style 538-067	Dielectric Type Code	Capacitance Range (pF)	WVDC @ 85°C
538 Series Trimmer				
CV31A080	CV32A080	A	2.0 - 8	350
--	--	A	3.0 - 10	350
CV31D150	CV32D150	D	3.0 - 15	200
CV31A180	CV32A180	A	5.5 - 18	350
--	--	D	5.5 - 25	200
CV31C250	CV32C250	C	8.0 - 25	350
CV31E600	CV32E600	F	15.0 - 60	200



Reference Sample Kit # SK0500-900

Ceramic Disc and WEECON Capacitors

Ceramic Disc Capacitors

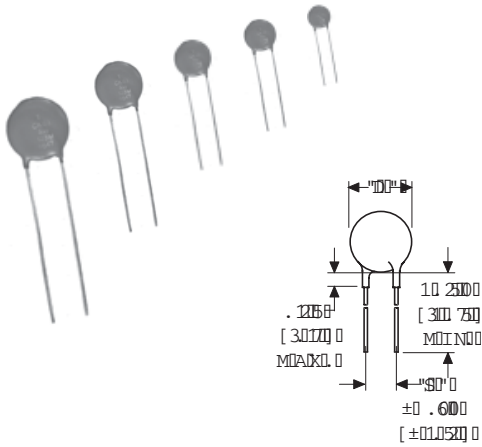

Part No.	Mil Number	Dimension D	Dimension S	Wire Gauge
Ceramic Disc Capacitors				
801-000-X5F0-102K	--	.360[9.14]	.250[6.35]	22
Mil-C-11015 Approved Discs				
838-040-X5U0-471M	CK60AW471M	.280[7.11]	.250[6.35]	22
838-040-X5U0-102M	CK60AW102M	.280[7.11]	.250[6.35]	22
831-040-X5U0-152M	CK60AW152M	.280[7.11]	.250[6.35]	22
838-040-X5R0-221K	CK60AX221K	.280[7.11]	.250[6.35]	22
831-040-X5R0-471K	CK60AX471K	.280[7.11]	.250[6.35]	22
838-040-X7R0-150K	CK60BX150K	.280[7.11]	.250[6.35]	22
838-040-X7R0-470K	CK60BX470K	.280[7.11]	.250[6.35]	22
838-040-X7R0-101K	CK60BX101K	.280[7.11]	.250[6.35]	22
801-040-X5U0-222M	CK61AW222M	.350[8.89]	.250[6.35]	22
811-040-X5U0-682M	CK62AW682M	.550[13.97]	.375[9.52]	22
811-040-X7R0-102K	CK62BX102K	.550[13.97]	.375[9.52]	22
841-040-X5U0-103M	CK63AW103M	.660[16.76]	.375[9.52]	20
848-040-X5U0-472M	CK63AW472M	.660[16.76]	.375[9.52]	20
848-040-X5U0-103M	CK63AY103M	.660[16.76]	.375[9.52]	20

Ceramic WEECON® Capacitors

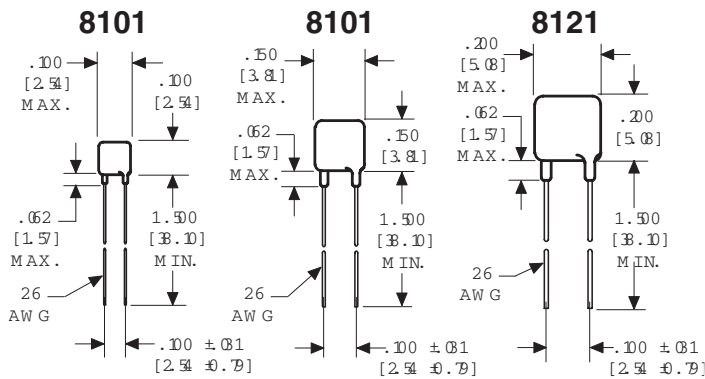

TUSONIX WEECON® Ceramic Plate Capacitors are the ideal product when it comes to demanding applications that need exact temperature compensation or very small and accurate capacitance values.

TUSONIX offers WEECON® Capacitors with temperature compensating dielectrics from NPO through N5600 and capacitance values from 1 pF to 12,000 pF for the temperature compensating dielectrics and up to .082 µF for Z5U ceramic dielectrics. Capacitance tolerance from 0.1 pF at a nominal capacitance of less than 10 pF or from 1 percent for nominal capacitance values of greater than 10 pF are available. Please refer to the Ceramic Capacitor Catalog 800 for further details.

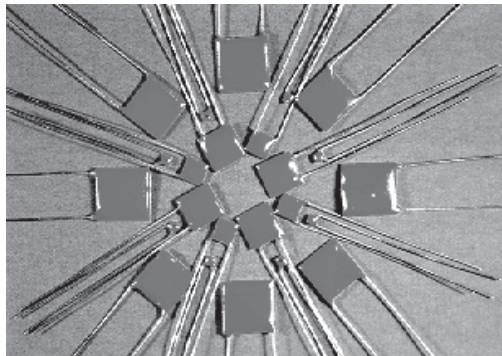

WEECON®s are encapsulated with a hard, bright polymeric coating, which is formulated to provide mechanical protection under normal environmental conditions.

Part No.	Cap.	Tol.
COG (NPO) Ultra-Stable		
8101-A100-C0K0-109B	1.0	±1 pF
8101-A100-C0K0-159B	pF	.1
8101-A100-C0K0-189B	1.5	.1
8101-A100-C0J0-229B	1.8	.1
8101-A100-C0J0-229C	2.2	.25
8101-A100-C0J0-279C	2.227	.25
8101-A100-C0J0-339B	3.3	.1
8101-A100-C0J0-339C	3.3	.25
8101-A100-C0J0-399B	3.9	.1
8101-A100-C0J0-399C	3.9	.25
8101-A100-C0H0-479C	4.7	.25
8101-A100-C0H0-479D	4.7	.5
8101-A100-C0H0-569C	5.6	.25
8101-A100-C0H0-569D	5.6	.5
8101-A100-C0H0-689C	6.8	.25
8101-A100-C0H0-689D	6.8	.5
8101-A100-C0H0-829C	8.2	.25
8101-A100-C0H0-829D	8.2	.5
8101-A100-C0G0-100C	10.0	.25
8101-A100-C0G0-100D	10.0	.5
8101-A100-C0G0-120J	12.0	5%
8101-A100-C0G0-150K	15	10%
8101-A100-C0G0-150J	15	5%
8101-A100-C0G0-180J	18	5%
8111-A100-C0G0-220K	22	10%
8111-A100-C0G0-220J	22	5%
8111-A100-C0G0-330K	33	10%
8111-A100-C0G0-330J	33	5%
8111-A100-C0G0-470K	47	10%
8111-A100-C0G0-470J	47	5%
8121-A100-C0G0-560J	56	5%
8121-A100-C0G0-680J	68	5%
8121-A100-C0G0-101K	100	10%
X7R Stable		
8101-A100-X7R0-221K	220	±10%
8101-A100-X7R0-271K	270	±10%
8101-A100-X7R0-331K	330	±10%
8101-A100-X7R0-471K	470	±10%
8111-A100-X7R0-102K	1000	±10%
8121-A100-X7R0-332K	3300	±10%

The products listed in this catalog are only a few of the thousands of variations that TUSONIX produces. For custom applications, please contact the factory direct.

Quick Connect Assembly Plates

www.tusonix.com Download Catalog 7000 (.pdf format)

Plate Style 77

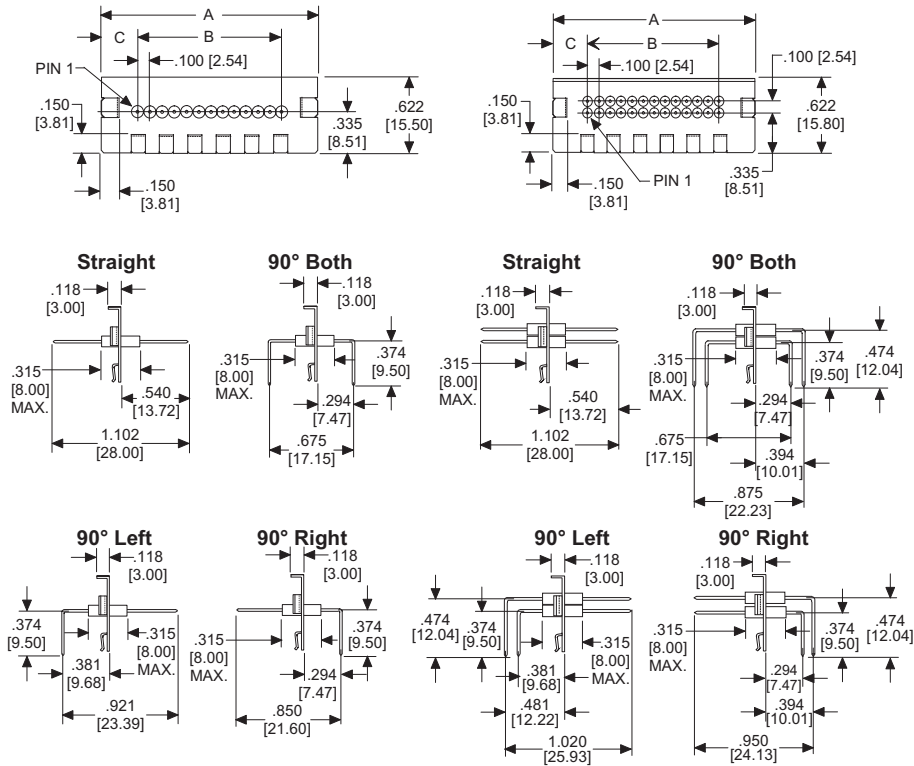
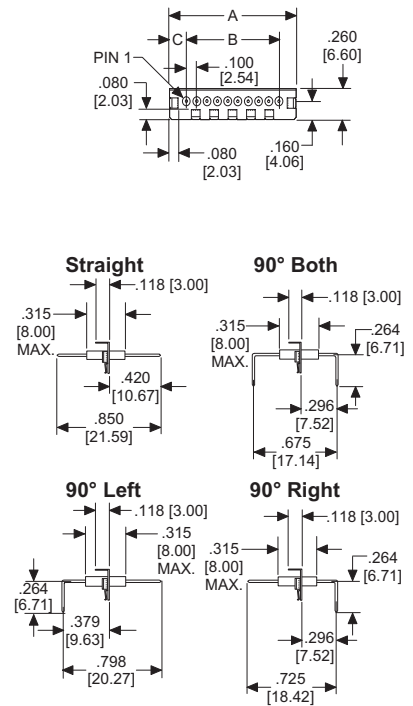

Plate Style 78



Style 77 Dimension "C"

Ref.#	A Length	No. of Lines per Row*	Dim. C
0	1.092 [27.74]	1-2	0.496 [12.60]
		3-4	0.396 [10.06]
		5-6	0.296 [7.52]
1	1.812 [46.02]	1	0.906 [23.01]
		2-3	0.806 [20.47]
		4-5	0.706 [17.93]
		6-7	0.606 [15.39]
		8-9	0.506 [12.85]
		10-11	0.406 [10.31]
12-13	0.306 [7.77]		

Style 78 Dimension "C"

Ref.#	A Length	No. of Lines per Row*	Dim. C
0	0.990 [25.15]	2-3	0.395 [10.03]
		4-5	0.295 [7.49]
		6-7	0.195 [4.95]
1	1.240 [31.49]	1-2	0.570 [14.48]
		3-4	0.470 [11.94]
		5-6	0.370 [9.40]
		7-8	0.270 [6.86]
		9-10	0.170 [4.32]

*When ordering a Miniature Quick Connect or another plate with a single row of filters, use the designation for the bottom row in the part number and enter a value of 00 in the top row of the part number.

**To select different filter values please provide TUSONIX with a table showing where each Filter will mount. Example:

A	A	S	S	S
A	A	S	S	S

Filter Performance

Part No.	Circuit	Capacitance		Typical No Load Insertion Loss dB @ 25°C per MIL-STD-220							
		Value	Tolerance	5MHz	10MHz	20MHz	50MHz	100MHz	200MHz	500MHz	1GHz
A	C	68pF	+80/-20%	--	--	--	--	--	3	10	16
B	C	100pF	+80/-20%	--	--	--	--	1	6	14	19
C	C	135pF	+100-0%	--	--	--	1	5	10	16	20
D	C	470pF	+80/-20%	--	--	2	7	12	17	23	27
E	C	820pF	+80/-20%	--	2	6	12	18	23	29	33
F	C	1000pF	+80/-20%	--	3	7	14	20	25	31	35
G	C	1500pF	+80/-20%	1	5	10	16	22	27	33	37
H	C	2500pF	+100-0%	5	10	15	21	25	32	36	40
K	C	4000pF	+100-0%	9	15	20	25	30	34	41	45
N	Pi	68pF	+80/-20%	--	--	--	--	1	5	15	20
O	Pi	100pF	+80/-20%	--	--	--	--	2	9	22	28
P	Pi	135pF	+100-0%	--	--	--	1	5	16	24	32
Q	Pi	470pF	+80/-20%	--	--	--	9	18	22	36	43
R	Pi	820pF	+80/-20%	--	--	3	13	22	30	42	50
S	Pi	1000pF	+80/-20%	--	2	7	16	24	36	48	55
T	Pi	1700pF	+100-0%	1	6	14	28	35	48	60	70
U	Pi	2500pF	+100-0%	3	9	16	28	41	52	62	70
V	Pi	5000pF	+100-0%	7	14	27	41	53	66	70	70
X	Filter Characteristics are determined by the customer.										
Y	Insul.	10pF	Max.	--	--	--	--	--	--	--	--
Z	Gnd Pin	--	--	--	--	--	--	--	--	--	--

Ordering Information: In order for TUSONIX to establish the exact configuration required, please provide the following encoded description number as outlined below. A TUSONIX part number will then be assigned to meet your specific needs.

The part number shown below represents the Quick Connect 1.812 length with two rows of seven lines per row. The filters are pi circuits with a capacitance of 1000pF and straight leads. 7712-0707-SA

77	1	2	07	07	S	A
Plate style	Plate Length	Filter Type	Bottom Row*	Top Row	Cap Value**	Lead Configuration
77=Quick Connect 78=Miniature QC 79=Standard	Ref. # from drawings above	C=1 Pi=2	Number of Filters	Number of Filters	See Table above	A=Straight B=90° Right C=90° Left D=90° Both

To request custom filtering, mechanical or material requirements not shown here, please contact our Customer Engineering Department at 520-744-0400.

Plate Style 79

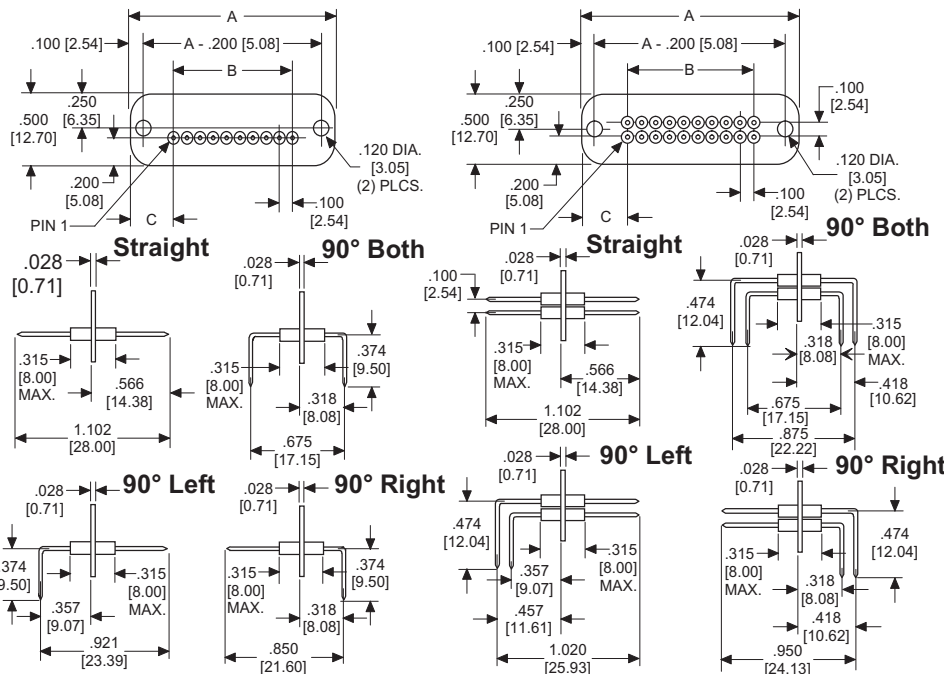

Style 79 Dimension "C"

Ref.#	A Length	No. of Lines per Row*	Dim. C
0	1.060 [26.92]	1	0.530 [13.46]
		2-3	0.430 [10.92]
		4-5	0.330 [8.38]
1	1.560 [39.62]	1-2	0.730 [18.54]
		3-4	0.630 [16.00]
		5-6	0.530 [13.46]
		7-8	0.430 [10.92]
		9-10	0.330 [8.38]
2	2.560 [65.02]	5-6	1.030 [26.16]
		7-8	0.930 [23.62]
		9-10	0.830 [21.08]
		11-12	0.730 [18.54]
		13-14	0.630 [16.00]
		15-16	0.530 [13.46]
		17-18	0.430 [10.92]
		19-20	0.330 [8.38]

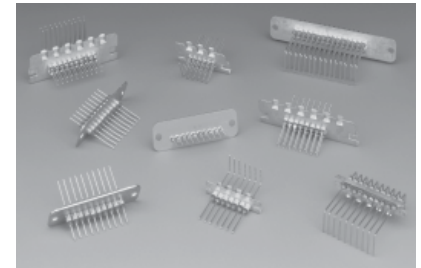

Part Number Index

Number	Page	Number	Page	Number	Page	Number	Page	Number	Page	Number	Page
357-001-Series	4	2425-018	4	4201-502	4	4300-020	3	4400-683	5	4700-056	2
513-000-Series	7	2425-601	4	4202-000	5	4300-021	3	4403-030	3	4700-058	2
513-001-Series	7	2499-003-Series	4	4202-004	5	4300-022	3	4403-031	3	4700-059	2
513-019-Series	7	2499-523-Series	5	4202-050	5	4300-023	3	4403-032	3	4701-001	2
518-000-Series	7	4100-000	2	4203-003	5	4300-024	3	4403-033	3	4701-002	2
518-002-Series	7	4100-003	2	4203-053	5	4300-680	3	4403-034	3	7602-501	6
528-000-Series	7	4100-053	2	4203-552	5	4300-681	3	4403-037	3	7603-501	6
528-002-Series	7	4101-000	2	4205-001	4	4400-016	3	4600-000	6	7604-501	6
538-000-Series	7	4101-001	2	4206-006	5	4400-030	3	4600-003	6	7605-501	6
538-002-Series	7	4101-002	2	4206-501	5	4400-031	3	4600-050	6	7606-501	6
538-006-Series	7	4101-003	2	4206-502	5	4400-032	3	4600-053	6	77XX -Series	9
538-011-Series	7	4101-502	2	4209-003	5	4400-033	3	4600-059	6	78XX -Series	9
538-026-Series	7	4101-503	2	4209-053	5	4400-034	3	4601-000	6	79XX -Series	10
538-074-Series	7	4102-000	2	4251-000	4	4400-037	3	4601-050	6	8101-A100-Series	8
801-000-Series	8	4151-000	2	4251-004	4	4400-076	5	4601-055	6	8111-A100-Series	8
801-040-Series	8	4151-001	2	4253-002	5	4400-093	5	4601-059	6	8121-A100-Series	8
805-000-Series	8	4201-000	4	4300-000	3	4400-094	5	4700-003	2		
811-040-Series	8	4201-001	4	4300-001	3	4400-095	5	4700-005	2		
831-040-Series	8	4201-050	4	4300-002	3	4400-096	5	4700-006	2		
838-040-Series	8	4201-051	4	4300-003	3	4400-097	5	4700-008	2		
841-040-Series	8	4201-053	4	4300-004	3	4400-098	5	4700-009	2		
848-040-Series	8	4201-501	4	4300-006	3	4400-099	5	4700-053	2		

Filters

MIL-PRF-15733	TUSONIX #	Page
/28-0001	4201-501	4
/33-0001	4101-502	2
/33-0002	4101-503	2
/61-0003	4206-502	5
/61-0004	4206-501	5
/61-0007	4203-552	5
/61-0008	4201-502	4
/62-0001	4101-501	2

Trimmer Capacitors

MIL-PRF-81	Page
CV 31	7
CV 32	7
CV 35	7
CV 36	7

Disc Capacitors

MIL-C-11015	Page
CK 60	8
CK 61	8
CK 62	8
CK 63	8