

UNCONTROLLED DOCUMENT

PART NUMBER  
GT-RLSAE350

REV.

REV. E.C.N. NUMBER AND REVISION COMMENTS

DATE

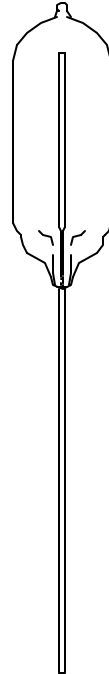
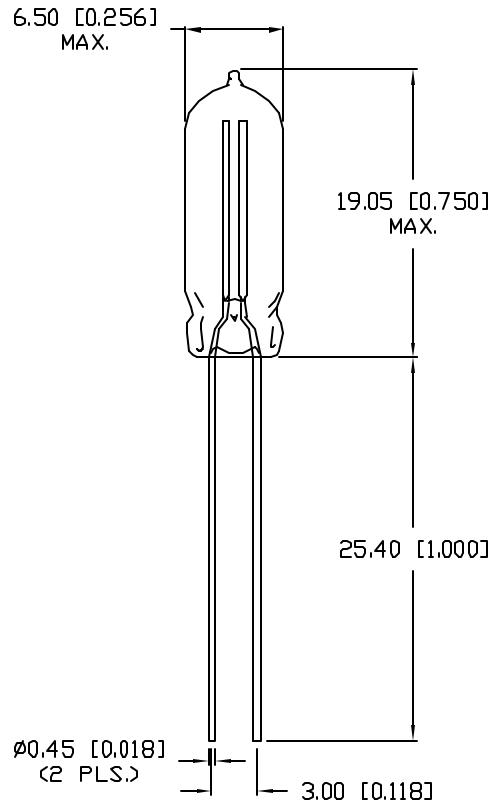

ELECTRICAL SPECIFICATIONS

CONDITION	SYMBOL	RATING
D.C. FIRING VOLTAGE:	(dv/dt 100V/S)	350±10% VDC
IMPULSE MAX. FIRING VOLTAGE:	(dv/dt 5KV/μS)	1200 VDC
IMPULSE CURRENT (KA):	(8/20μS)	1.5 kA MAX.
IMPULSE SURGE LIFE(X):	(8/20μS 500A)	1000 TIMES MIN.
D.C. HOLDOVER VOLTAGE:	(150mS MAX.)	50 V D.C.
A.C. DISCHARGE CURRENT:	(1S X 5 TIMES)	1 AMP
A.C. FOLLOW-ON CURRENT:	(1/2 CYCLE, 60Hz)	1 AMP
INSULATION RESISTANCE(MIN.):	(100VDC)	10 <sup>8</sup> Ω
INTER-ELECTRODE CAPACITANCE:	(1.0 KHz)	1.0 PF MAX.

ENVIRONMENTAL SPECIFICATIONS PER MIL-STD 202

TEST	METHOD	CONDITION	RATING
VIBRATION TESTING:	204B	C	C10-55Hz, .06DA
THERMAL SHOCK:	107	B	-65 TO +125°C
HUMIDITY:	103B	B	95% Re. HUMIDITY
TEMP CYCLING:	102A	C	-65 TO +125°C
SOLDERABILITY:	208	B	
OPERATION TEMP.	-	-	-40 TO +100°C

RESPONSE TIME

SURGE TYPE	(Rt MAX.)
1Kv/mS	1 x 10 <sup>-8</sup> sec.
1Kv/μS	1 x 10 <sup>-8</sup> sec.
5Kv/μS	1 x 10 <sup>-9</sup> sec.

UNCONTROLLED DOCUMENT

\*UNLESS OTHERWISE SPECIFIED TOLERANCE IS ±0.25mm (±0.010")

REV.

PART NUMBER  
GT-RLSAE350

**CONFIDENTIAL INFORMATION**  
THE INFORMATION CONTAINED IN THIS DOCUMENT IS THE PROPERTY OF LUMEX INC. EXCEPT AS SPECIFICALLY AUTHORIZED IN WRITING BY LUMEX INC., THE HOLDER OF THIS DOCUMENT SHALL KEEP ALL INFORMATION CONTAINED HEREIN CONFIDENTIAL AND SHALL PROTECT SAME IN WHOLE OR IN PART FROM DISCLOSURE AND DISSEMINATION TO ALL THIRD PARTIES.

**LUMEX**  
INCORPORATED

290 E. HELLEN ROAD  
PALATINE, ILLINOIS 60067  
PHONE: 1-847-359-2790  
WEB: HTTP://WWW.LUMEX.COM

LIGHT DUTY RADIAL LEAD ARRESTOR, 350VDC.

**RELIABILITY NOTE**  
OUR MANY YEARS OF EXPERIENCE DATA ACCUMULATION INDICATE THAT SOLDER HEAT IS A MAJOR CAUSE OF EARLY AND FUTURE FAILURE. PLEASE PAY ATTENTION TO YOUR SOLDERING PROCESS.

DRAWN BY: CHECKED BY: APPROVED BY: DATE: 6-10-99

KS/BC

PAGE: 1 OF 1

SCALE: N/A