

## DC to 40 GHz MMIC Medium Power Voltage Controlled Attenuator

### Features

- Wideband operation: DC to 40 GHz
- Low Insertion Loss (<3 dB)
- Good Input/Output Match
- Medium Attenuation (max. 17 dB)
- Size: 1640 x 920 mm

### Description

The MMS005AA is a medium-power DC-40 GHz PHEMT FET attenuator. The performance of the device is controlled by two bias voltages,  $V_{series}$  and  $V_{shunt}$ . The bias voltages control the match and attenuation of the device when varied between -1V and +0.5V DC. For additional information please refer to the tables of recommended bias settings optimized for flat insertion loss and flat attenuation.

### Application

The MMS005AA MMIC voltage controlled attenuator is ideal for high frequency and broadband applications in test equipment, commercial and military systems. The attenuator is especially suited for applications needing a moderate amount of adjustable attenuation and fast attenuation control from DC to millimeter frequencies. The device is also useful as a general purpose building block in communications systems.

### Key Characteristics: $Z_0=50\Omega$

Parameter	Description	Min	Typ	Max
Attenuation (dB)	DC to 40 GHz	0	-	17
Flatness ( $\pm$ dB)	DC to 40 GHz	-	1	-
Insertion Loss (dB)	DC to 40 GHz	-	-	3
S11 (dB)	DC to 40 GHz	-	-10	-8
S22 (dB)	DC to 40 GHz	-	-10	-8
P1dB (dBm)	1dB Gain Compression 0 to 15 dB Attenuation	8	-	-

## Optimized for Flat Attenuation (Typical)

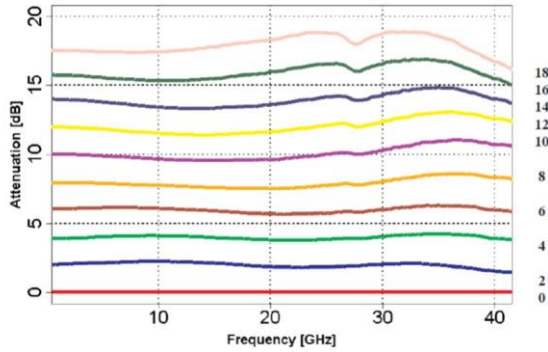
**MMS005AA Attenuation**

*Typical on wafer measured performance*

Vseries (V)	Vshunt (V)	Att. (dB)*
-0.625	0.343	18.3
-0.625	-0.287	15.9
-0.625	-0.1	13.6
-0.616	-0.456	11.6
-0.608	-0.501	9.6
-0.601	-0.544	7.5
-0.595	-0.583	5.7
-0.569	-0.622	3.8
-0.55	-0.7	1.8
0.5	-1	0

## Optimized for Flat Insertion Loss (Typical)

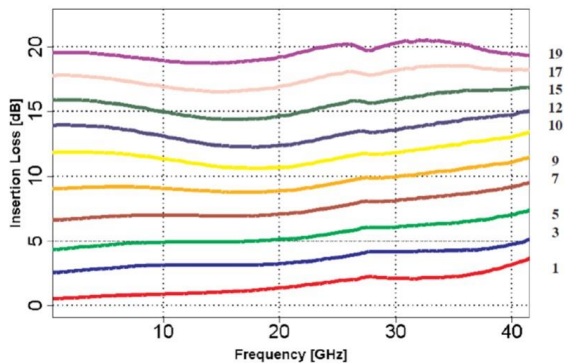
**MMS005AA Insertion Loss**

*Typical on wafer measured performance*

Vseries (V)	Vshunt (V)	Att. (dB)*
-650	0	19.2
-0.65	-0.312	16.9
-0.65	-0.413	14.6
-0.65	-0.475	12.4
-0.641	-0.513	10.7
-0.618	-0.549	8.9
0.595	-0.583	7.1
-0.568	-0.624	5.1
-0.55	-0.7	3.3
0.5	-1	1.4

Note: (\*) Midband

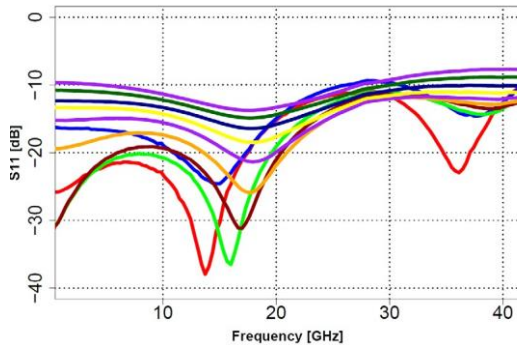
**MMS005AA S11**

*Typical on wafer measured performance*

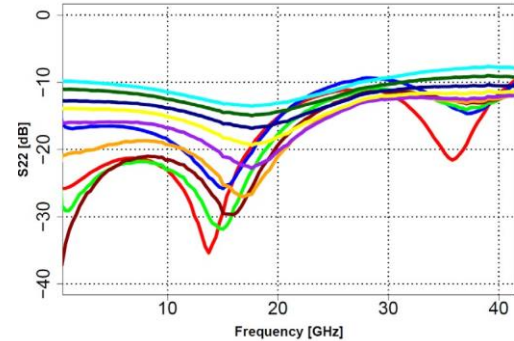
**MMS005AA S22**

*Typical on wafer measured performance*

**Table 1: Supplemental Specifications**

Parameter	Description	Min	Typ	Max
Vseries	Attenuation Control Voltage	-2V	-	0.5V
Vshunt	Attenuation Control Voltage	-2V	-	0.5V
Dcin	DC feedback circuit input	0 V	0.25 V	1 V
Dcout	DC feedback circuit output	0 V	0.25 V	1 V
GND	Backside Ground Plane	-	-	22dBm
Tch	Channel Temperature	-	-	150°C
Θch	Thermal Resistance (Tcase=85°C)	-	60o C/Watt	-

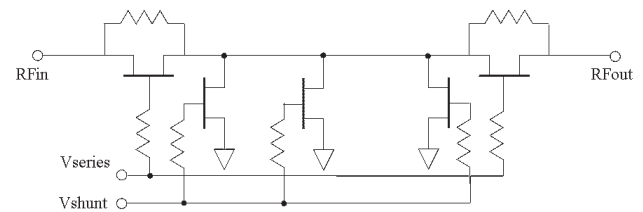
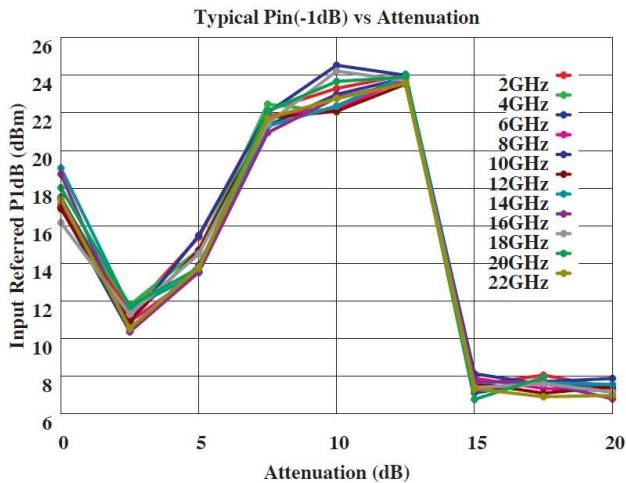
**Typical Pin (1dB) vs Attenuation**
**MMS005AA Simplified Schematic Diagram**

*Typical on evaluated package measured performance*

**Pick-up and Chip Handling:**

This MMIC has exposed air bridges on the top surface. **Do not pick up chip with vacuum on the die center**; handle from edges or use a collet.

**ESD Handling and Bonding:**

**This MMIC is ESD sensitive**; preventive measures should be taken during handling, die attach, and bonding.

**Epoxy die attach is recommended.** Please review our application note MM-APP-0001 handling and die attach recommendations, on our website for more handling, die attach and bonding information.

### DC Feedback Circuit for Variable Attenuator:

The following feedback circuit does a good job of providing the series and shunt biases to the variable attenuator for a user-selected amount of attenuation.

The circuit references a 1/3 scale version of the microwave attenuator, which is used for the DC feedback loop. Because the devices are 1/3 the size of the unscaled attenuator, the reference impedance is 3 times larger (150W instead of 50W).

The circuit uses two ordinary opamps to provide the bias control voltages to the attenuator. Opamp OA1 senses the input impedance of the attenuator and adjusts the series FET gate voltage  $V_{series}$  so that the impedance looking into the attenuator is 150W. The input impedance can be adjusted with the potentiometer shown in the schematic (Figure 8). When this feedback loop is at DC equilibrium the voltage at  $DC_{in}$  will be  $V_{ref}/2$ .

The second opamp OA2 adjusts the shunt FET gate voltage so that the DC output voltage  $DC_{out}$  is equal to the voltage at the opamp negative input terminal. When 0V is applied to the negative input terminal of OA2, the attenuation is maximized.

Conversely, if  $V_{ref}/2$  is applied at the negative input of OA2 then the attenuation is minimized.

A voltage divider with the shunt resistor terminated by the voltage  $V_{ref}$  makes for a convenient conversion of voltage to attenuation. If the input to the divider  $V_{atten}$  is set to 0 volts then the negative input of OA2 will have a value of  $V_{ref}/2$  and the attenuator will have minimum attenuation.

Conversely, if  $V_{atten}$  is set to  $-V_{ref}$  then the negative input of OA2 is set 0V and the attenuator will have maximum attenuation. This makes the calculation of  $V_{atten}$  easy and requires a minimum number of parts.

### Scaled DC Attenuator

Circuit (1/3 scale attenuator)

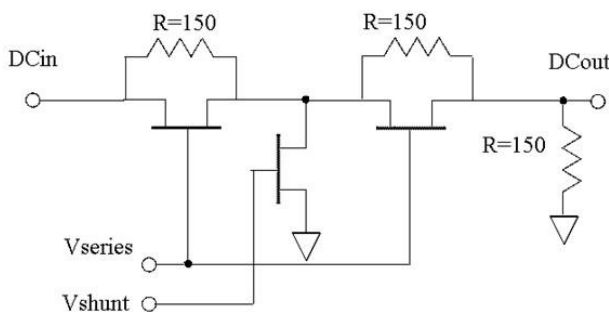

The DC feedback circuit to adjust the attenuator

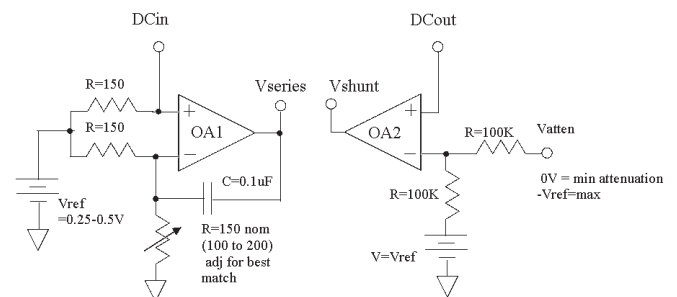

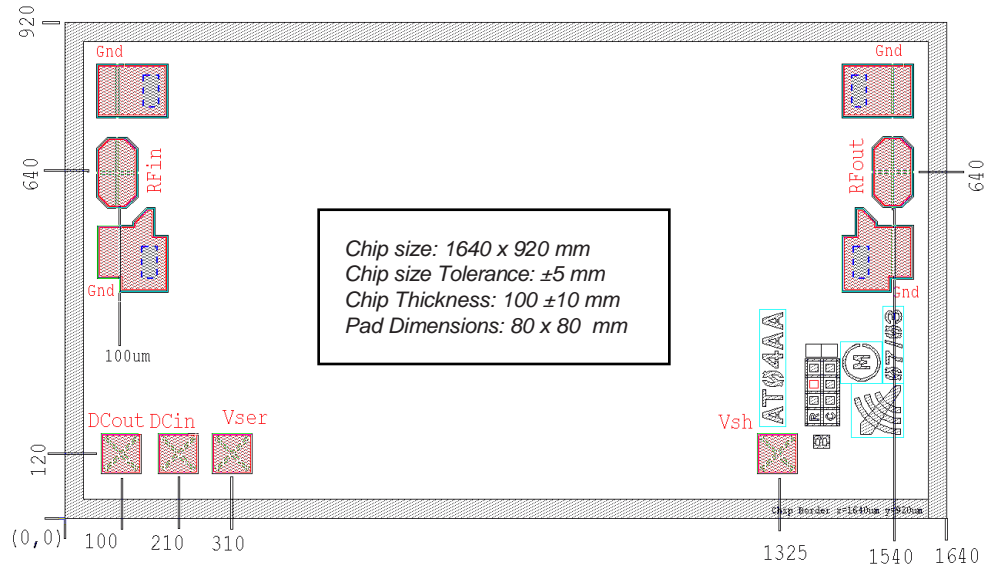
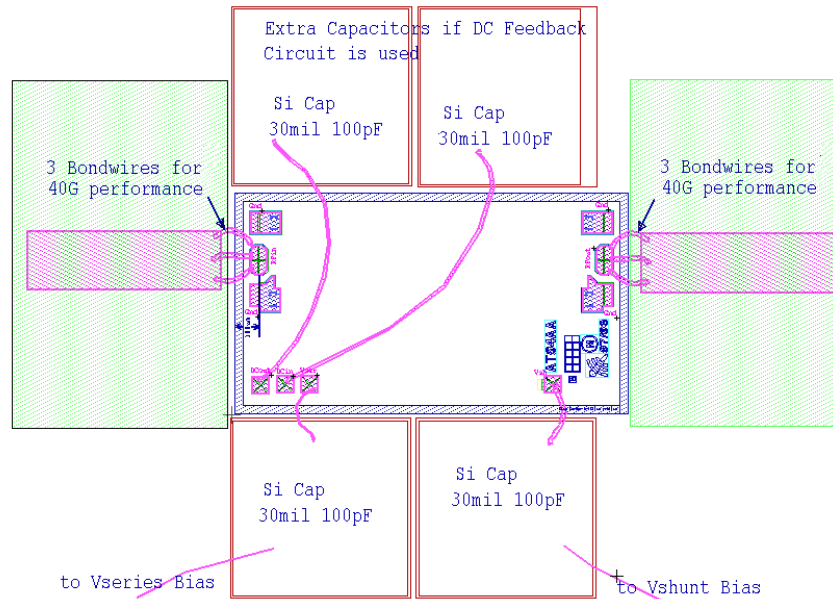
**Physical Characteristics of MMS005AA**

**Assembly Diagram of MMS005AA**

---

Information contained in this document is proprietary to Microsem. This document may not be modified in any way without the express written consent of Microsemi. Product processing does not necessarily include testing of all parameters. Microsemi reserves the right to change the configuration and performance of the product and to discontinue product at any time.

---

**Microsemi Corporate Headquarters**

One Enterprise, Aliso Viejo CA 92656 USA  
Within the USA: +1 (949) 380-6100  
Sales: +1 (949) 380-6136  
Fax: +1 (949) 215-4996

Microsemi Corporation (Nasdaq: MSCC) offers a comprehensive portfolio of semiconductor and system solutions for communications, defense and security, aerospace, and industrial markets. Products include high-performance and radiation-hardened analog mixed-signal integrated circuits, FPGAs, SoCs, and ASICs; power management products; timing and synchronization devices and precise time solutions, setting the world's standard for time; voice processing devices; RF solutions; discrete components; security technologies and scalable anti-tamper products; Power-over-Ethernet ICs and midspans; as well as custom design capabilities and services. Microsemi is headquartered in Aliso Viejo, Calif. and has approximately 3,400 employees globally. Learn more at [www.microsemi.com](http://www.microsemi.com).

---

© 2014 Microsemi Corporation. All rights reserved. Microsemi and the Microsemi logo are trademarks of Microsemi Corporation. All other trademarks and service marks are the property of their respective owners.