

LM231B – 2323 Middle Power LED



Introduction

Features

- Beam Angle : 120°
- Precondition : JEDEC Level 2a
- Dimension : 2.3 x 2.3 x 0.7 mm
- ESD withstand Voltage : up to ± 5 KV [HBM]
- Reliability Test : LM-80 qualified

Applications

- INDOOR LIGHTING : Ambient Light, LED tube, Down light, LED bulb and Ceiling Light

SAMSUNG ELECTRONICS

95, Samsung2-Ro, Giheung-Gu,
Yongin-City, Gyeonggi-Do 446-711, KOREA

Contents

1. Product Code Information	-----	3
2. Luminous Flux Characteristics	-----	10
3. Characteristics	-----	12
4. Typical Characteristics Graph	-----	13
5. Outline Drawing & Dimension	-----	19
6. Reliability Test Items & Conditions	-----	20
7. Solder Conditions	-----	21
8. Tape & Reel	-----	22
9. Label Structure	-----	23
10. Packing Structure	-----	24
11. Kitting Rule	-----	26
12. Precaution For Use	-----	41
13. Hazard Substance Analysis Report	-----	44
14. Revision History	-----	64



1. Product Code Information

1) Luminous Flux Bins ($T_s = 25^\circ\text{C}$)

Nominal CCT	Product Code	Flux Rank	Sorting Condition $I_m @65\text{mA}$	
			Flux Bin	Intensity Range (cd)
				Flux Range (Φ_{v_s}, I_m)
2700K	SPMWHT223MD5WAW0S0 SPMWHT223MD5WAWKS0 SPMWHT223MD5WAWMS0	S0	S1	19.81 ~ 22.78
			S2	22.78 ~ 26.20
			S3	26.20 ~ 30.13
3000K	SPMWHT223MD5WAV0S0 SPMWHT223MD5WAVKS0 SPMWHT223MD5WAVMS0	S0	S1	19.81 ~ 22.78
			S2	22.78 ~ 26.20
			S3	26.20 ~ 30.13
3500K	SPMWHT223MD5WAU0S0 SPMWHT223MD5WAUKS0 SPMWHT223MD5WAUMS0	S0	S1	19.81 ~ 22.78
			S2	22.78 ~ 26.20
			S3	26.20 ~ 30.13
4000K	SPMWHT223MD5WAT0S0 SPMWHT223MD5WATKS0 SPMWHT223MD5WATMS0	S0	S1	20.55 ~ 23.56
			S2	23.56 ~ 27.09
			S3	27.09 ~ 31.16
5000K	SPMWHT223MD5WAR0S0 SPMWHT223MD5WARKS0 SPMWHT223MD5WARMS0	S0	S1	20.55 ~ 23.56
			S2	23.56 ~ 27.09
			S3	27.09 ~ 31.16
5700K	SPMWHT223MD5WAQ0S0 SPMWHT223MD5WAQKS0 SPMWHT223MD5WAQMS0	S0	S1	20.55 ~ 23.56
			S2	23.56 ~ 27.09
			S3	27.09 ~ 31.16
6500K	SPMWHT223MD5WAP0S0 SPMWHT223MD5WAPKS0 SPMWHT223MD5WAPMS0	S0	S1	20.55 ~ 23.56
			S2	23.56 ~ 27.09
			S3	27.09 ~ 31.16

Notes:

SAMSUNG ELECTRONICS maintains a tolerance of $\pm 5\%$ on Luminous Flux measurements

2) Color Bins ($T_s = 25^\circ\text{C}$)

1) Color Binning

Nominal CCT	Product Code	Color Rank	Chromaticity Bins
2700K	SPMWHT223MD5WAW0S0	W0(Whole bin)	W1, W2, W3, W4, W5, W6, W7, W8, W9, WA, WB, WC, WD, WE, WF, WG
	SPMWHT223MD5WAWKS0	WK(Kitting bin)	-
	SPMWHT223MD5WAWMS0	WM(Quarter bin)	W6, W7, WA, WB
3000K	SPMWHT223MD5WAV0S0	V0(Whole bin)	V1, V2, V3, V4, V5, V6, V7, V8, V9, VA, VB, VC, VD, VE, VF, VG
	SPMWHT223MD5WAVKS0	VK(Kitting bin)	-
	SPMWHT223MD5WAVMS0	VM(Quarter bin)	V6, V7, VA, VB
3500K	SPMWHT223MD5WAU0S0	U0(Whole bin)	U1, U2, U3, U4, U5, U6, U7, U8, U9, UA, UB, UC, UD, UE, UF, UG
	SPMWHT223MD5WAUKS0	UK(Kitting bin)	-
	SPMWHT223MD5WAUMS0	UM(Quarter bin)	U6, U7, UA, UB
4000K	SPMWHT223MD5WAT0S0	T0(Whole bin)	T1, T2, T3, T4, T5, T6, T7, T8, T9, TA, TB, TC, TD, TE, TF, TG
	SPMWHT223MD5WATKS0	TK(Kitting bin)	-
	SPMWHT223MD5WATMS0	TM(Quarter bin)	T6, T7, TA, TB



1) Color Binning(Continued)

Nominal CCT	Product Code	Color Rank	Chromaticity Bins
5000K	SPMWHT223MD5WAR0S0	R0(Whole bin)	R1, R2, R3, R4, R5, R6, R7, R8
	SPMWHT223MD5WARKS0	RK(Kitting bin)	-
	SPMWHT223MD5WARMS0	RM(Quarter bin)	R6, R7, RA, RB
5700K	SPMWHT223MD5WAQ0S0	Q0(Whole bin)	Q1, Q2, Q3, Q4, Q5, Q6, Q7, Q8
	SPMWHT223MD5WAQKS0	QK(Kitting bin)	-
	SPMWHT223MD5WAQMS0	QM(Quarter bin)	Q6, Q7, QA, QB
6500K	SPMWHT223MD5WAP0S0	P0(Whole bin)	P1, P2, P3, P4, P5, P6, P7, P8
	SPMWHT223MD5WAPKS0	PK(Kitting bin)	-
	SPMWHT223MD5WAPMS0	PM(Quarter bin)	P6, P7, PA, PB

2) Chromaticity Region & Coordinates

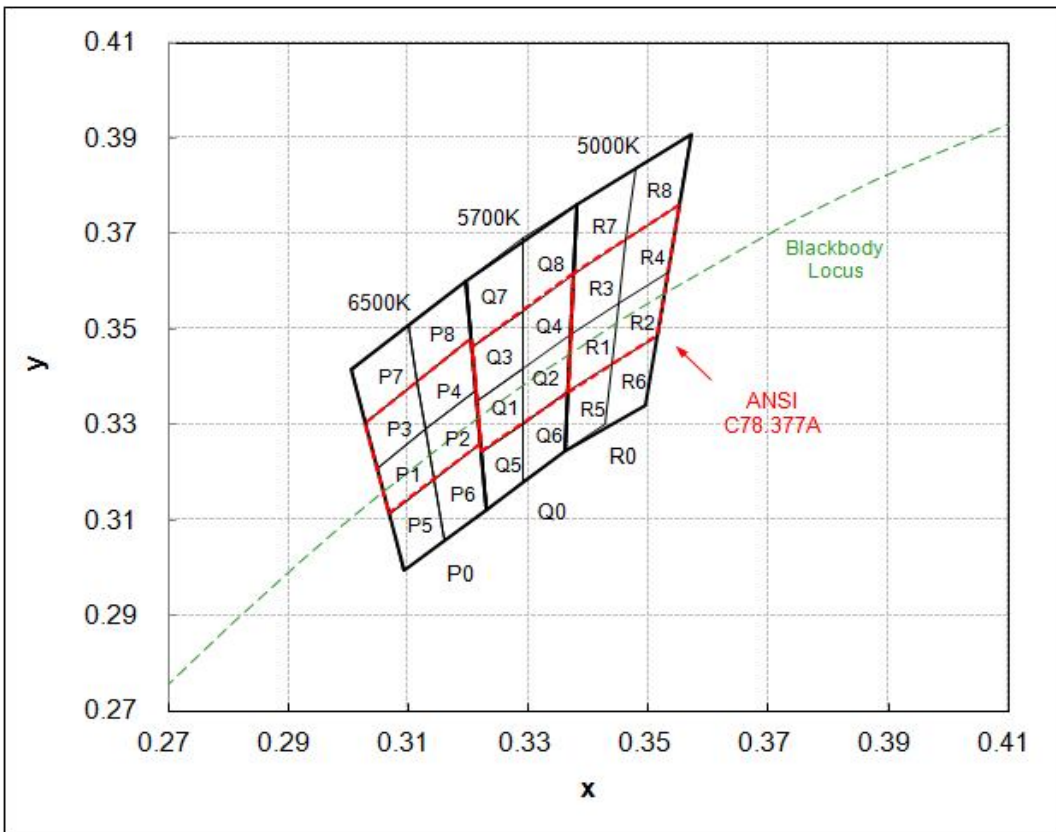
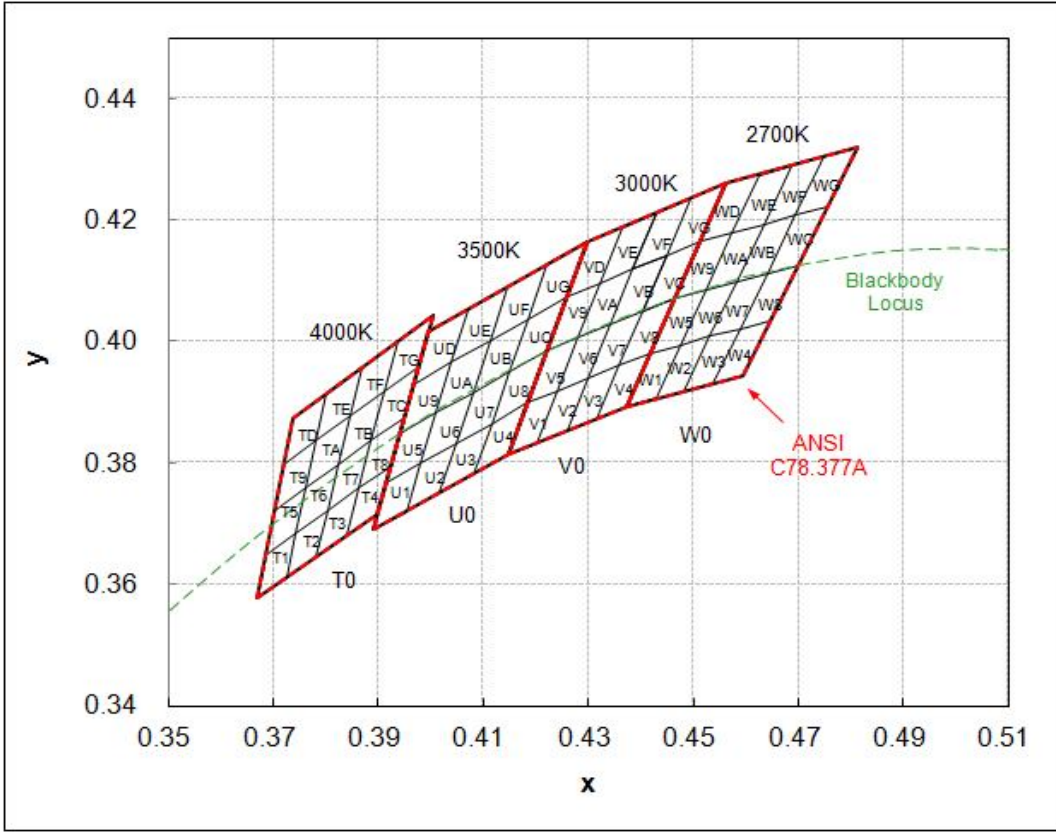

2) Chromaticity Region & Coordinates (Continued)

Region	CIE X	CIE Y	Region	CIE X	CIE Y
W rank (2700K)					
W1	0.4373	0.3893	W9	0.4465	0.4071
	0.4418	0.3981		0.4513	0.4164
	0.4475	0.3994		0.4573	0.4178
	0.4428	0.3906		0.4523	0.4085
W2	0.4428	0.3906	WA	0.4523	0.4085
	0.4475	0.3994		0.4573	0.4178
	0.4532	0.4008		0.4634	0.4193
	0.4483	0.3919		0.4582	0.4099
W3	0.4483	0.3919	WB	0.4582	0.4099
	0.4532	0.4008		0.4634	0.4193
	0.4589	0.4021		0.4695	0.4207
	0.4538	0.3931		0.4641	0.4112
W4	0.4538	0.3931	WC	0.4641	0.4112
	0.4589	0.4021		0.4695	0.4207
	0.4646	0.4034		0.4756	0.4221
	0.4593	0.3944		0.4700	0.4126
W5	0.4418	0.3981	WD	0.4513	0.4164
	0.4465	0.4071		0.4562	0.4260
	0.4523	0.4085		0.4624	0.4274
	0.4475	0.3994		0.4573	0.4178
W6	0.4475	0.3994	WE	0.4573	0.4178
	0.4523	0.4085		0.4624	0.4274
	0.4582	0.4099		0.4687	0.4289
	0.4532	0.4008		0.4634	0.4193
W7	0.4532	0.4008	WF	0.4634	0.4193
	0.4582	0.4099		0.4687	0.4289
	0.4641	0.4112		0.4750	0.4304
	0.4589	0.4021		0.4695	0.4207
W8	0.4589	0.4021	WG	0.4695	0.4207
	0.4641	0.4112		0.4750	0.4304
	0.4700	0.4126		0.4813	0.4319
	0.4646	0.4034		0.4756	0.4221

Region	CIE X	CIE Y	Region	CIE X	CIE Y
V rank (3000K)					
V1	0.4147	0.3814	V9	0.4221	0.3984
	0.4183	0.3898		0.4259	0.4073
	0.4242	0.3919		0.4322	0.4096
	0.4203	0.3833		0.4281	0.4006
V2	0.4203	0.3833	VA	0.4281	0.4006
	0.4242	0.3919		0.4322	0.4096
	0.4300	0.3939		0.4385	0.4119
	0.4259	0.3853		0.4342	0.4028
V3	0.4259	0.3853	VB	0.4342	0.4028
	0.4300	0.3939		0.4385	0.4119
	0.4359	0.3960		0.4449	0.4141
	0.4316	0.3873		0.4403	0.4049
V4	0.4316	0.3873	VC	0.4403	0.4049
	0.4359	0.3960		0.4449	0.4141
	0.4418	0.3981		0.4513	0.4164
	0.4373	0.3893		0.4465	0.4071
V5	0.4183	0.3898	VD	0.4259	0.4073
	0.4221	0.3984		0.4299	0.4165
	0.4281	0.4006		0.4364	0.4188
	0.4242	0.3919		0.4322	0.4096
V6	0.4242	0.3919	VE	0.4322	0.4096
	0.4281	0.4006		0.4364	0.4188
	0.4342	0.4028		0.4430	0.4212
	0.4300	0.3939		0.4385	0.4119
V7	0.4300	0.3939	VF	0.4385	0.4119
	0.4342	0.4028		0.4430	0.4212
	0.4403	0.4049		0.4496	0.4236
	0.4359	0.3960		0.4449	0.4141
V8	0.4359	0.3960	VG	0.4449	0.4141
	0.4403	0.4049		0.4496	0.4236
	0.4465	0.4071		0.4562	0.4260
	0.4418	0.3981		0.4513	0.4164

2) Chromaticity Region & Coordinates (Continued)

Region	CIE X	CIE Y	Region	CIE X	CIE Y
U rank (3500K)					
U1	0.3889	0.3690	U9	0.3941	0.3848
	0.3915	0.3768		0.3968	0.3930
	0.3981	0.3800		0.4040	0.3966
	0.3953	0.3720		0.4010	0.3882
U2	0.3953	0.3720	UA	0.4010	0.3882
	0.3981	0.3800		0.4040	0.3966
	0.4048	0.3832		0.4113	0.4001
	0.4017	0.3751		0.4080	0.3916
U3	0.4017	0.3751	UB	0.4080	0.3916
	0.4048	0.3832		0.4113	0.4001
	0.4116	0.3865		0.4186	0.4037
	0.4082	0.3782		0.4150	0.3950
U4	0.4082	0.3782	UC	0.4150	0.3950
	0.4116	0.3865		0.4186	0.4037
	0.4183	0.3898		0.4259	0.4073
	0.4147	0.3814		0.4221	0.3984
U5	0.3915	0.3768	UD	0.3968	0.3930
	0.3941	0.3848		0.3996	0.4015
	0.4010	0.3882		0.4071	0.4052
	0.3981	0.3800		0.4040	0.3966
U6	0.3981	0.3800	UE	0.4040	0.3966
	0.4010	0.3882		0.4071	0.4052
	0.4080	0.3916		0.4146	0.4089
	0.4048	0.3832		0.4113	0.4001
U7	0.4048	0.3832	UF	0.4113	0.4001
	0.4080	0.3916		0.4146	0.4089
	0.4150	0.3950		0.4222	0.4127
	0.4116	0.3865		0.4186	0.4037
U8	0.4116	0.3865	UG	0.4186	0.4037
	0.4150	0.3950		0.4222	0.4127
	0.4221	0.3984		0.4299	0.4165
	0.4183	0.3898		0.4259	0.4073

Region	CIE X	CIE Y	Region	CIE X	CIE Y
T rank (4000K)					
T1	0.367	0.3578	T9	0.3702	0.3722
	0.3726	0.3612		0.3763	0.376
	0.3744	0.3685		0.3782	0.3837
	0.3686	0.3649		0.3719	0.3797
T2	0.3726	0.3612	TA	0.3763	0.3760
	0.3783	0.3646		0.3825	0.3798
	0.3804	0.3721		0.3847	0.3877
	0.3744	0.3685		0.3782	0.3837
T3	0.3783	0.3646	TB	0.3825	0.3798
	0.3840	0.3681		0.3887	0.3836
	0.3863	0.3758		0.3912	0.3917
	0.3804	0.3721		0.3847	0.3877
T4	0.384	0.3681	TC	0.3887	0.3837
	0.3898	0.3716		0.395	0.3875
	0.3924	0.3794		0.3978	0.3958
	0.3863	0.3758		0.3912	0.3917
T5	0.3686	0.3649	TD	0.3719	0.3797
	0.3744	0.3685		0.3782	0.3837
	0.3763	0.376		0.3802	0.3916
	0.3702	0.3722		0.3736	0.3874
T6	0.3744	0.3685	TE	0.3782	0.3837
	0.3804	0.3721		0.3847	0.3877
	0.3825	0.3798		0.3869	0.3958
	0.3763	0.376		0.3802	0.3916
T7	0.3804	0.3721	TF	0.3847	0.3877
	0.3863	0.3758		0.3912	0.3917
	0.3887	0.3836		0.3937	0.4001
	0.3825	0.3798		0.3869	0.3958
T8	0.3863	0.3758	TG	0.3912	0.3917
	0.3924	0.3794		0.3978	0.3958
	0.395	0.3875		0.4006	0.4044
	0.3887	0.3836		0.3937	0.4001



2) Chromaticity Region & Coordinates (Continued)

Region	CIE X	CIE Y	Region	CIE X	CIE Y
R rank (5000K)					
R1	0.3371	0.3490	R5	0.3366	0.3369
	0.3451	0.3554		0.3440	0.3428
	0.3440	0.3427		0.3429	0.3307
	0.3366	0.3369		0.3361	0.3245
R2	0.3451	0.3554	R6	0.3440	0.3428
	0.3533	0.3620		0.3515	0.3487
	0.3515	0.3487		0.3495	0.3339
	0.3440	0.3427		0.3429	0.3307
R3	0.3376	0.3616	R7	0.3381	0.3762
	0.3463	0.3687		0.3480	0.3840
	0.3451	0.3554		0.3463	0.3687
	0.3371	0.3490		0.3376	0.3616
R4	0.3463	0.3687	R8	0.3480	0.3840
	0.3551	0.3760		0.3571	0.3907
	0.3533	0.3620		0.3551	0.3760
	0.3451	0.3554		0.3463	0.3687
Q rank (5700K)					
Q1	0.3215	0.3350	Q5	0.3222	0.3243
	0.3290	0.3417		0.3290	0.3300
	0.3290	0.3300		0.3290	0.3180
	0.3222	0.3243		0.3231	0.3120
Q2	0.3290	0.3417	Q6	0.3290	0.3300
	0.3371	0.3490		0.3366	0.3369
	0.3366	0.3369		0.3361	0.3245
	0.3290	0.3300		0.3290	0.3180
Q3	0.3207	0.3462	Q7	0.3196	0.3602
	0.3290	0.3538		0.3290	0.3690
	0.3290	0.3417		0.3290	0.3538
	0.3215	0.3350		0.3207	0.3462
Q4	0.3290	0.3538	Q8	0.3290	0.3690
	0.3376	0.3616		0.3381	0.3762
	0.3371	0.3490		0.3376	0.3616
	0.3290	0.3417		0.3290	0.3538

Region	CIE X	CIE Y	Region	CIE X	CIE Y
P rank (6500K)					
P1	0.3068	0.3113	P5	0.3093	0.2993
	0.3144	0.3186		0.3161	0.3059
	0.3130	0.3290		0.3144	0.3186
	0.3048	0.3207		0.3068	0.3113
P2	0.3144	0.3186	P6	0.3161	0.3059
	0.3221	0.3261		0.3231	0.3120
	0.3213	0.3373		0.3221	0.3261
	0.3130	0.3290		0.3144	0.3186
P3	0.3048	0.3207	P7	0.3028	0.3304
	0.3130	0.3290		0.3115	0.3391
	0.3115	0.3391		0.3099	0.3509
	0.3028	0.3304		0.3005	0.3415
P4	0.3130	0.3290	P8	0.3115	0.3391
	0.3213	0.3373		0.3205	0.3481
	0.3205	0.3481		0.3196	0.3602
	0.3115	0.3391		0.3099	0.3509

Notes:

SAMSUNG ELECTRONICS maintains ± 0.005 tolerance of CCx, CCy

2. Luminous Flux Characteristics ($T_s = 25^\circ\text{C}$)

Nominal CCT	Minimum CRI	If(mA)	Vf(V)	Power(W)	Flux(lm)	lm/W
2700K	80	50	2.80	0.14	18.1	129
		60	2.83	0.17	21.6	127
		65	2.86	0.19	23.2	125
		70	2.89	0.20	24.8	123
		80	2.92	0.23	28.3	121
		90	2.95	0.27	31.6	119
		100	2.97	0.30	34.6	116
		150	3.09	0.46	50.1	108
3000K	80	50	2.80	0.14	18.4	131
		60	2.83	0.17	21.9	129
		65	2.86	0.19	23.6	127
		70	2.89	0.20	25.3	125
		80	2.92	0.23	28.8	123
		90	2.95	0.27	32.1	121
		100	2.97	0.30	35.2	118
		150	3.09	0.46	51.0	110
3500K	80	50	2.80	0.14	18.6	133
		60	2.83	0.17	22.2	131
		65	2.86	0.19	23.9	129
		70	2.89	0.20	25.6	126
		80	2.92	0.23	29.2	125
		90	2.95	0.27	32.5	123
		100	2.97	0.30	35.6	120
		150	3.09	0.46	51.6	111
4000K	80	50	2.80	0.14	19.1	136
		60	2.83	0.17	22.8	134
		65	2.86	0.19	24.5	132
		70	2.89	0.20	26.2	130
		80	2.92	0.23	29.9	128
		90	2.95	0.27	33.3	126
		100	2.97	0.30	36.5	123
		150	3.09	0.46	52.9	114

Notes:

Luminous Flux(Φ_v , lm) values are for representative reference only



2. Luminous Flux Characteristics (Continued)

Nominal CCT	Minimum CRI	If(mA)	Vf(V)	Power(W)	Flux(lm)	lm/W
5000K	80	50	2.80	0.14	19.3	138
		60	2.83	0.17	23.1	136
		65	2.86	0.19	24.8	133
		70	2.89	0.20	26.5	131
		80	2.92	0.23	30.3	130
		90	2.95	0.27	33.7	127
		100	2.97	0.30	37.0	124
		150	3.09	0.46	53.6	116
5700K	80	50	2.80	0.14	19.3	137
		60	2.83	0.17	23.0	135
		65	2.86	0.19	24.7	133
		70	2.89	0.20	26.4	131
		80	2.92	0.23	30.1	129
		90	2.95	0.27	33.6	127
		100	2.97	0.30	36.8	124
		150	3.09	0.46	53.4	115
6500K	80	50	2.80	0.14	19.3	137
		60	2.83	0.17	23.0	135
		65	2.86	0.19	24.7	133
		70	2.89	0.20	26.4	131
		80	2.92	0.23	30.1	129
		90	2.95	0.27	33.6	127
		100	2.97	0.30	36.8	124
		150	3.09	0.46	53.4	115

Notes:

Luminous Flux(Φ_v , lm) values are for representative reference only

3. Characteristics

1) Absolute Maximum Rating

Item	Symbol	Rating	Condition
Operating temperature range	T_{op}	-40 °C ~ +85 °C	-
Storage temperature range	T_{stg}	-40 °C ~ +100 °C	-
LED junction temperature	T_J	110 °C	-
Forward Current	I_F	150 mA	-
Peak Pulsed Forward Current	I_{FP}	300 mA	Duty 1/10 pulse width 10ms
Thermal resistance	$R_{th, j-s}$	20 °C/W	Junction to solder point
Assembly Process Temperature	-	260 °C, < 10sec	-
ESD	-	5kV	HBM

2) Electro-optical Characteristics

Item	Unit	Nominal CCT	Product Code	Rank	Min	Typ	Max		
Forward Voltage ¹⁾ (V_F) (@65 mA, $T_s = 25^\circ\text{C}$)	V	-	-	WA	AZ	2.70	-	2.80	
					A1	2.80	-	2.90	
					A2	2.90	-	3.00	
					A3	3.00	-	3.10	
					A4	3.10	-	3.20	
Luminous Flux ²⁾ (Φ_v) (@65 mA, $T_s = 25^\circ\text{C}$)	lm	2700K (W☆)	*WAW☆S0	S1	19.81	-	22.78		
				S2	22.78	-	26.20		
				S3	26.20	-	30.13		
		3000K (V☆)	*WAV☆S0	S1	19.81	-	22.78		
				S2	22.78	-	26.20		
				S3	26.20	-	30.13		
		3500K (U☆)	*WAU☆S0	S1	19.81	-	22.78		
				S2	22.78	-	26.20		
				S3	26.20	-	30.13		
		4000K (T☆)	*WAT☆S0	S1	20.55	-	23.56		
				S2	23.56	-	27.09		
				S3	27.09	-	31.16		
		5000K (R☆)	*WAR☆S0	S1	20.55	-	23.56		
				S2	23.56	-	27.09		
				S3	27.09	-	31.16		
		5700K (Q☆)	*WAQ☆S0	S1	20.55	-	23.56		
				S2	23.56	-	27.09		
				S3	27.09	-	31.16		
		6500K (P☆)	*WAP☆S0	S1	20.55	-	23.56		
				S2	23.56	-	27.09		
				S3	27.09	-	31.16		
		Reverse Voltage (@5 mA, $T_s = 25^\circ\text{C}$)	V	-	-	-	0.7	-	1.2
		Color Rendering Index ³⁾ (R_a)	-	-	-	5	80	-	-
		Special CRI ⁴⁾ (R9)	-	-	-	-	0	-	-

Notes:

1)~4) SAMSUNG ELECTRONICS maintains a tolerance of $V_F:\pm 0.1$ V, $\Phi_v:\pm 5$ %, $R_a:\pm 3.0$, R9 ± 6.5 on measurements

5) " * " is Product Code of "SPMWHT223MD5"

4. Typical Characteristics Graph (@65mA, $T_s = 25^\circ\text{C}$)

1) Spectrum Distribution

[CCT : 2700K & 3000K]

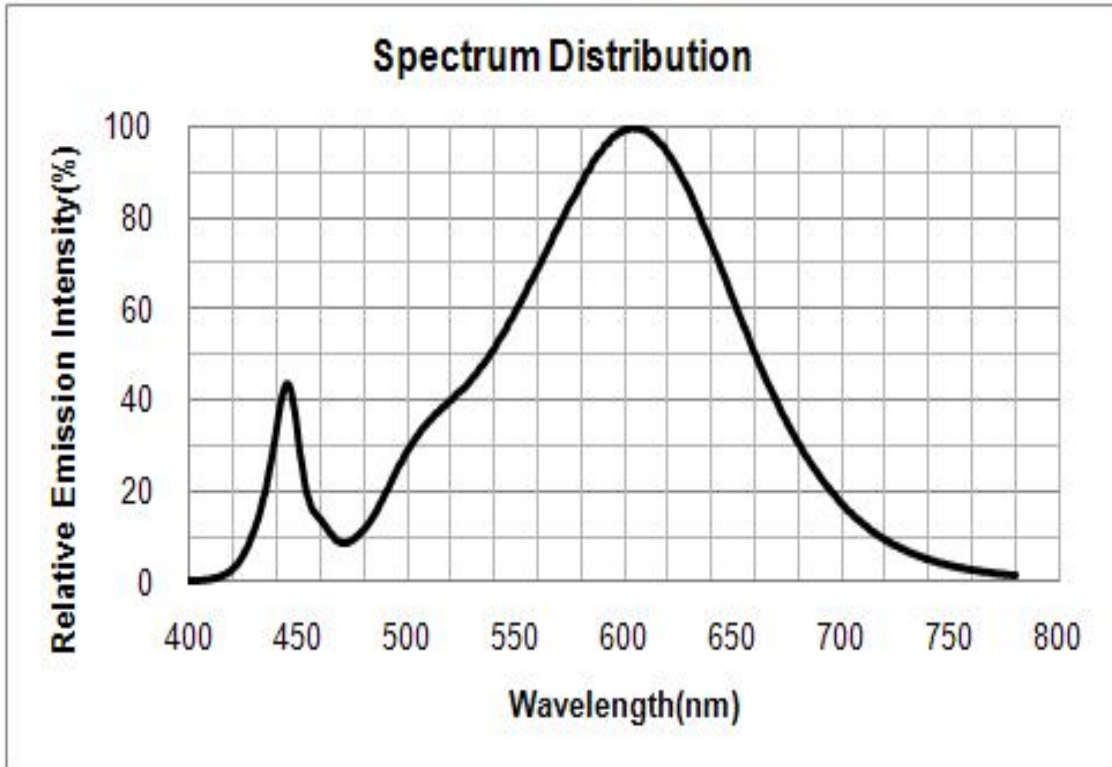

[CCT : 3500K & 4000K]

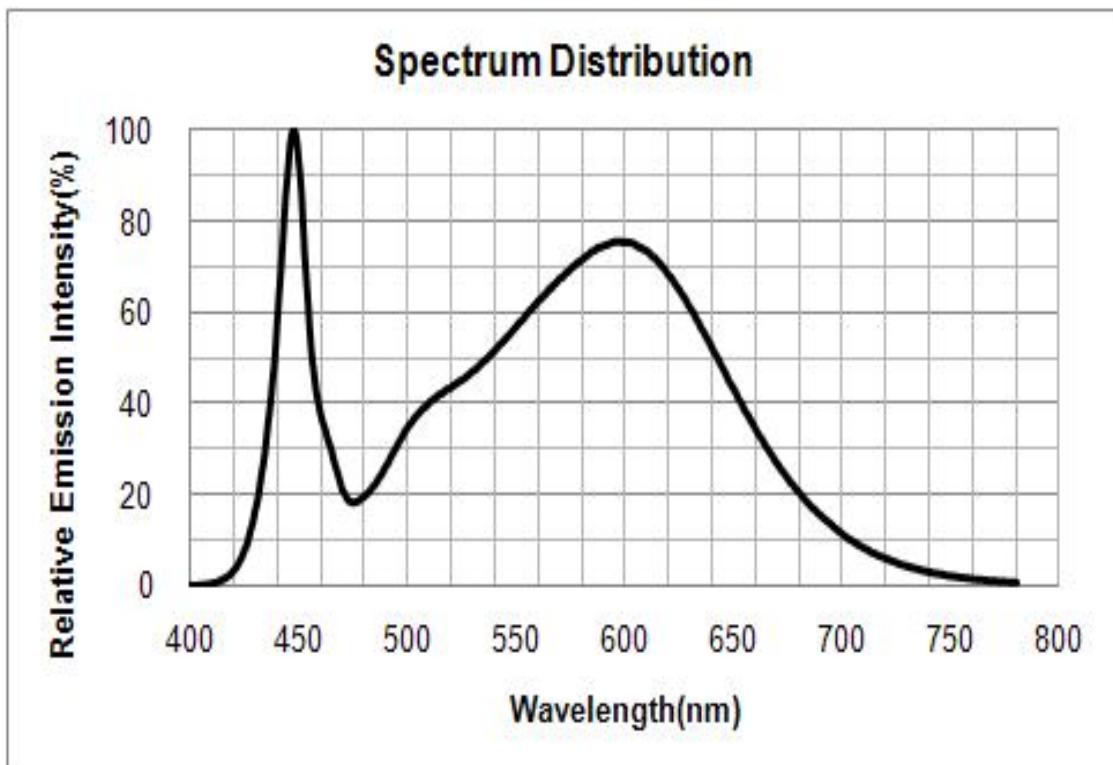

[CCT : 5000K]

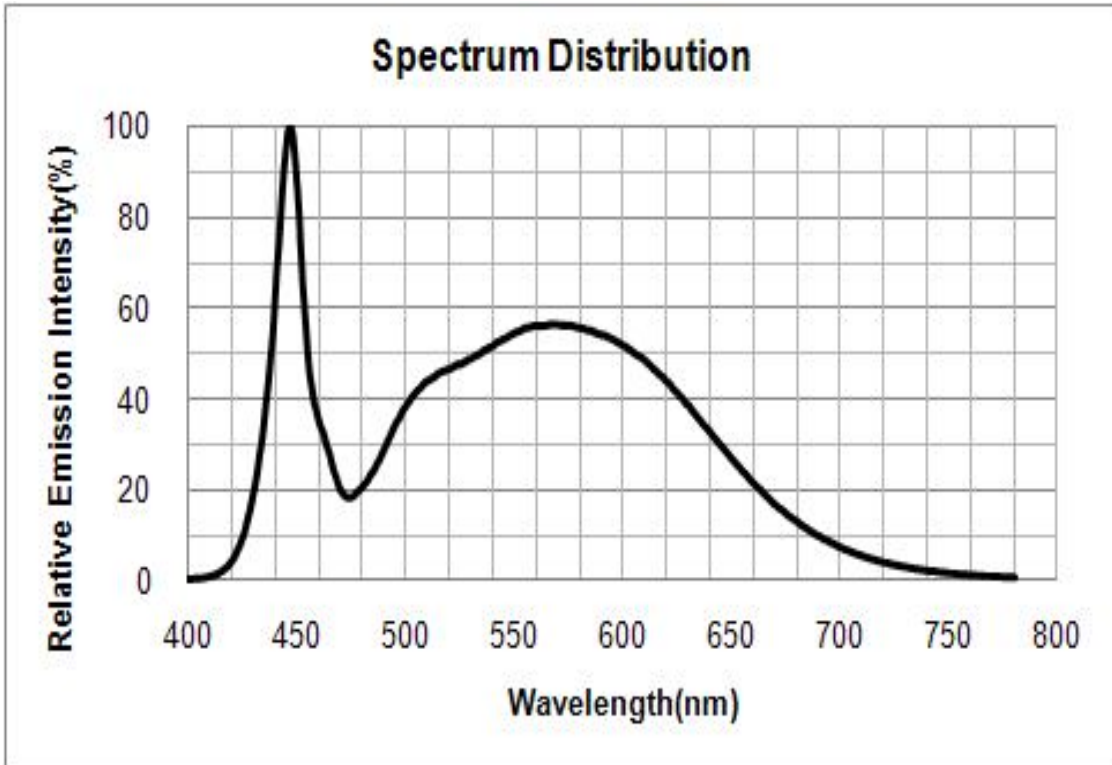

[CCT : 5700K~6500K]

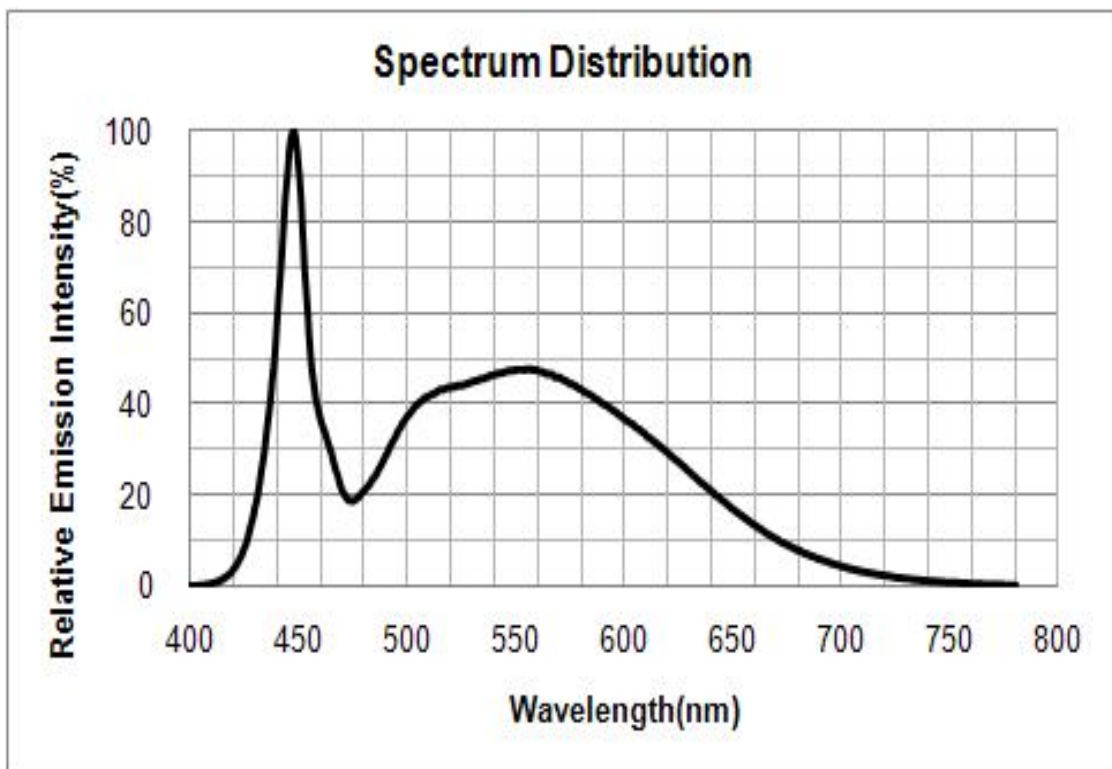

2) Forward Current Characteristics ($T_s = 25^\circ\text{C}$)

[Relative Luminous Flux vs. Forward Current]

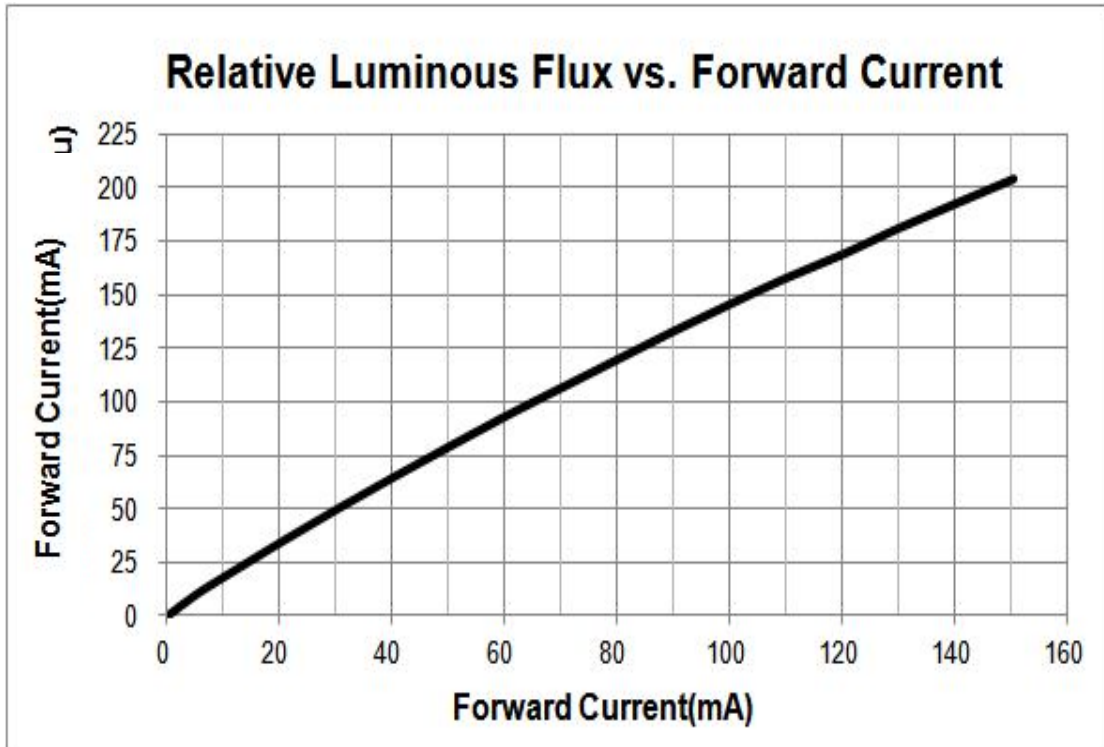

[Forward Current vs. Forward Voltage]

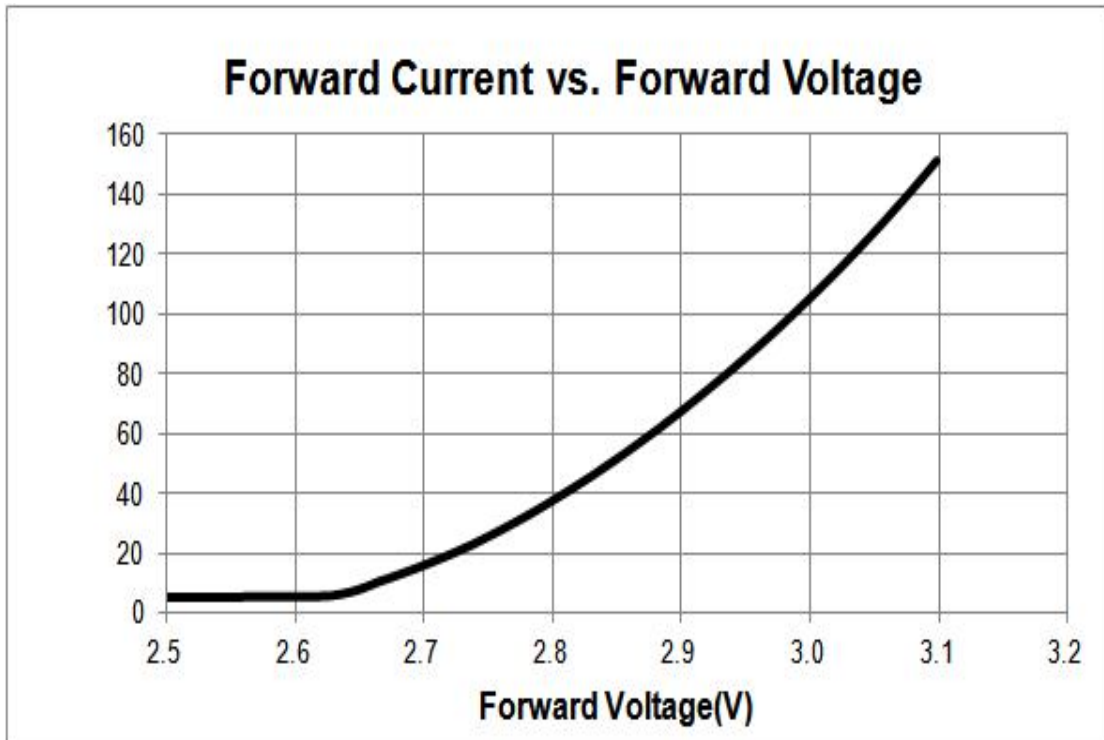

3) Temperature Characteristics (@65mA)

[Relative Luminous Flux vs. Ts]

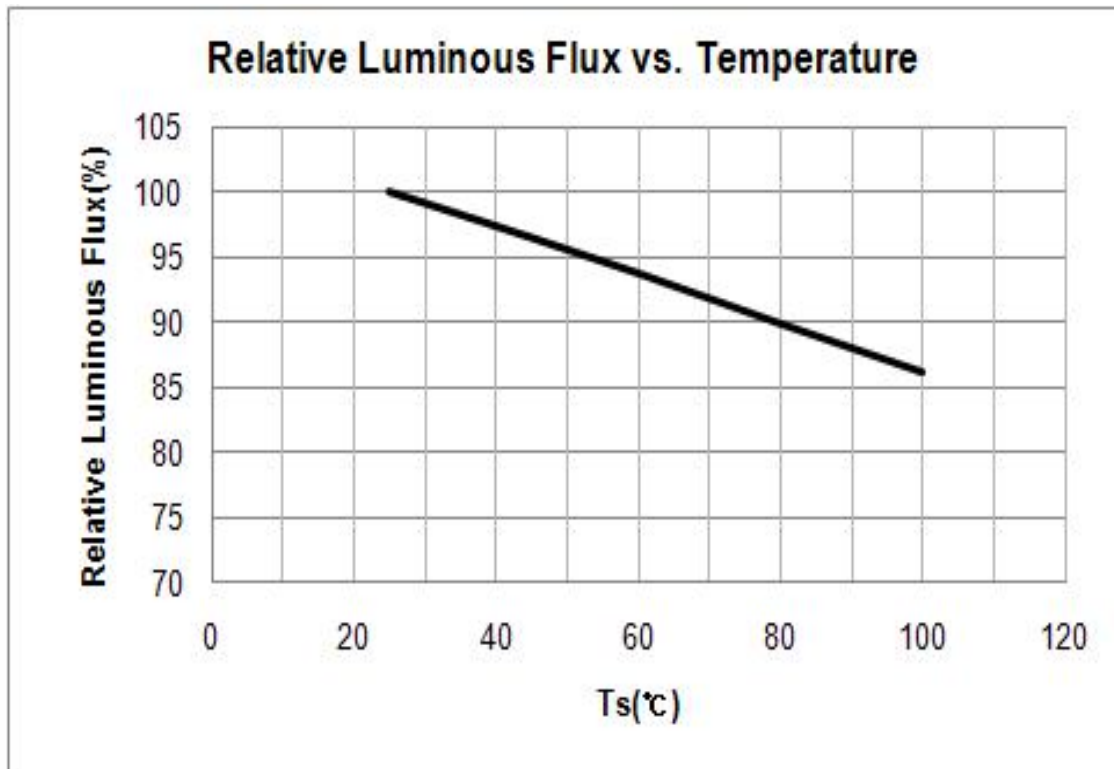

[Forward Voltage vs. Ts]

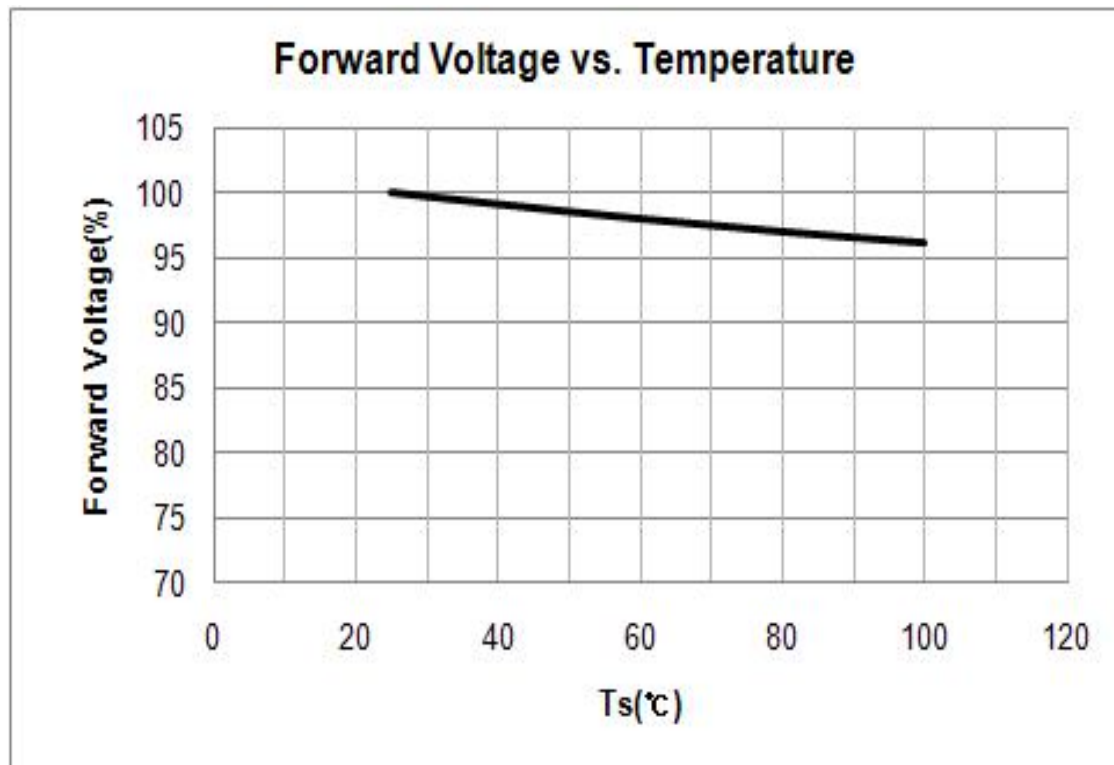

[Color Δx , Δy vs. T_s]

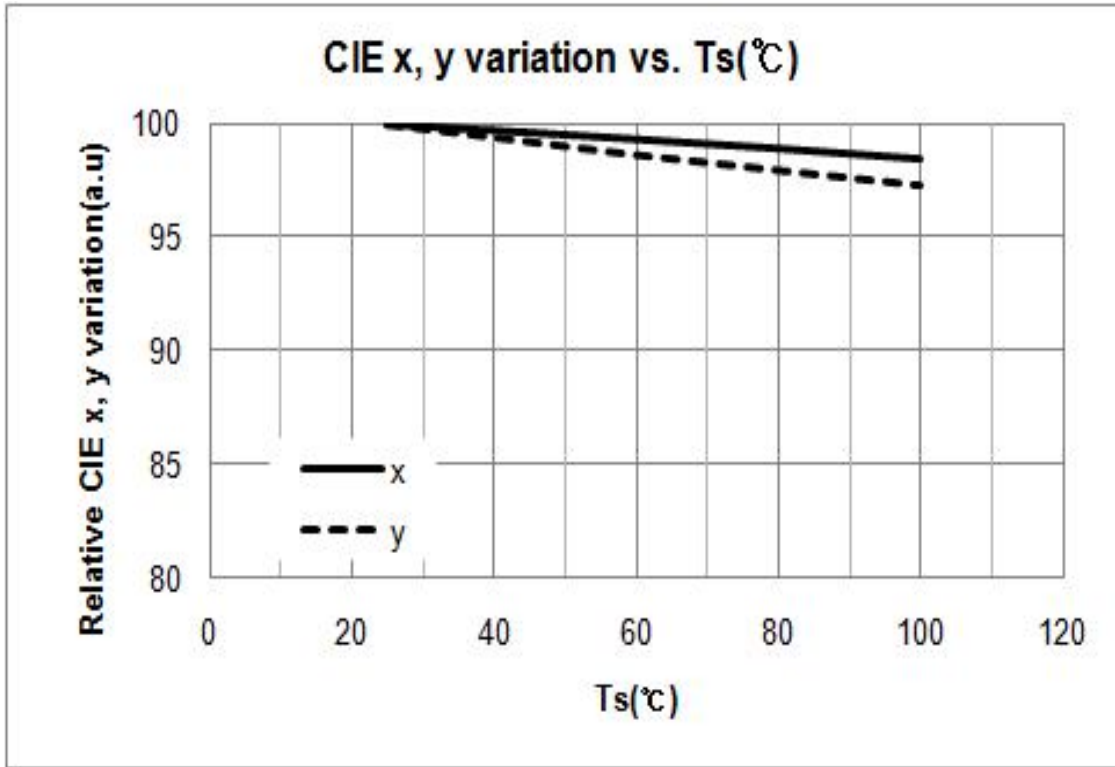

4) Color shift Characteristics ($T_s = 25^\circ\text{C}$)

[Forward Current vs. Color Δx , Δy]

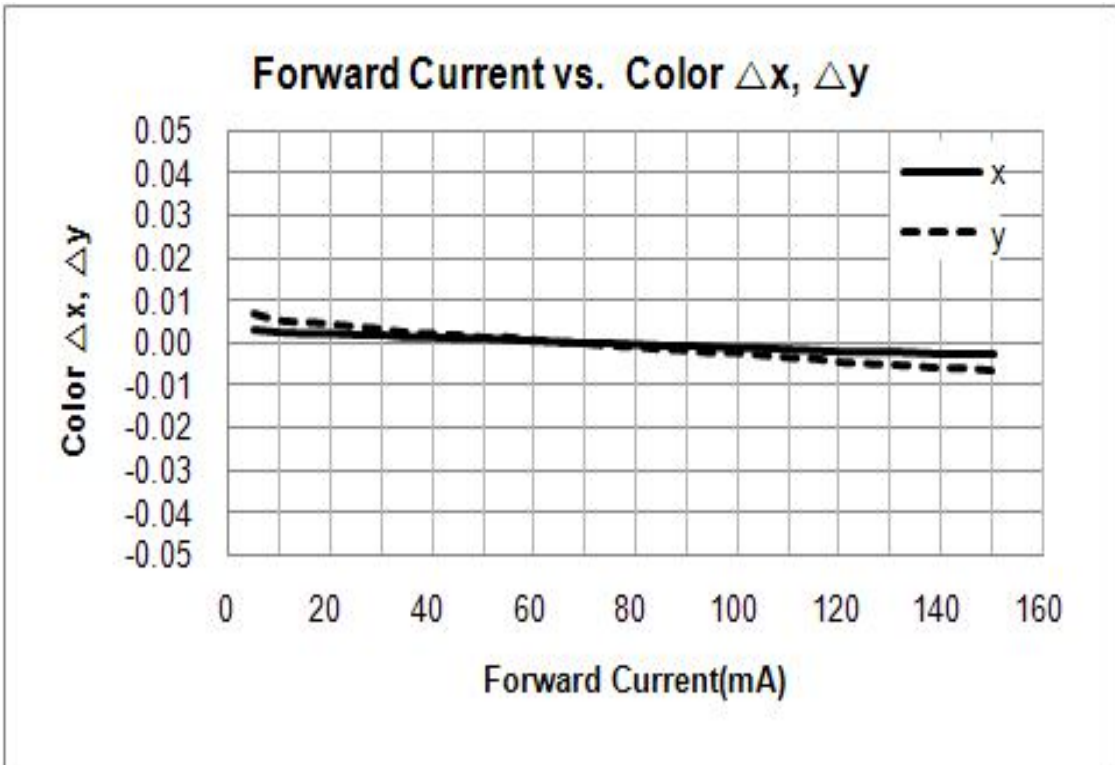

5) Derating Curve

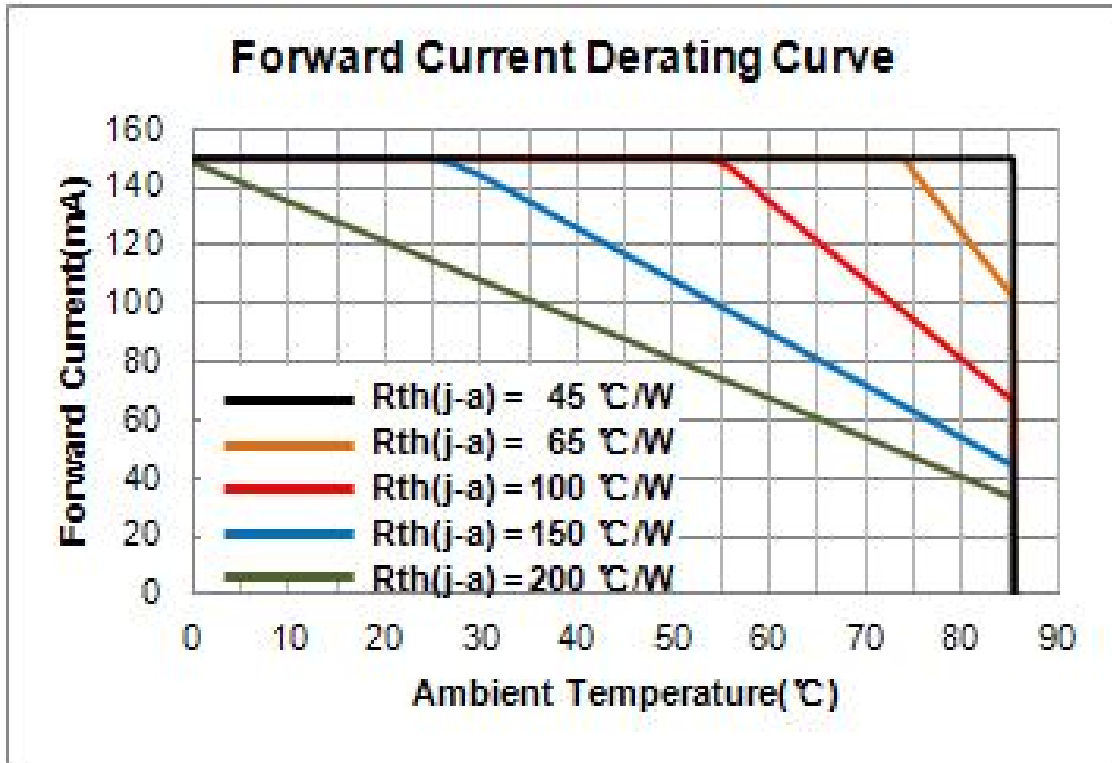

6) Beam Angle Characteristics (@65mA, $T_s = 25^\circ\text{C}$)

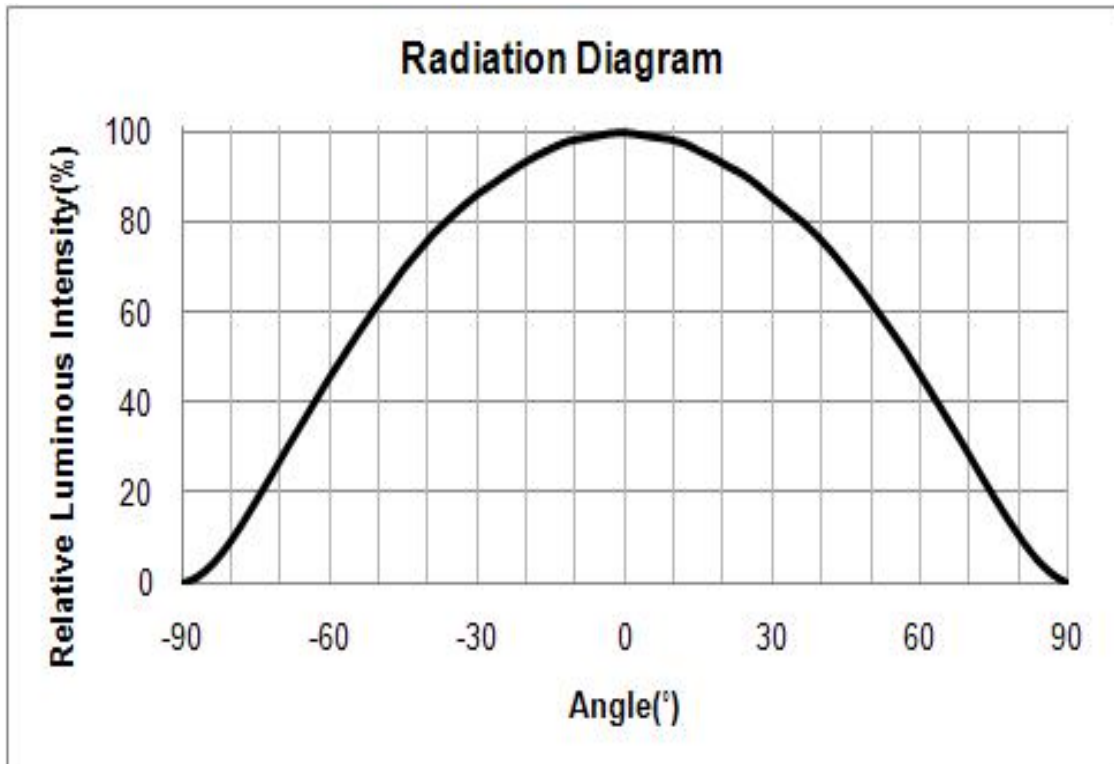

5. Outline Drawing & Dimension

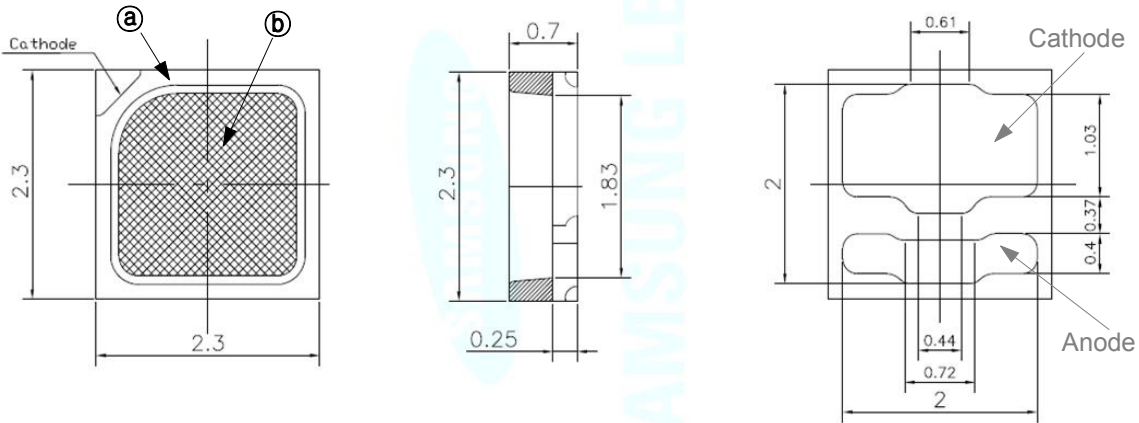

1. Tolerance is ± 0.1 mm
2. The maximum compressing force is 15N on the silicone ①
3. Do not place pressure on the encapsulation resin ②

Recommended Land Pattern

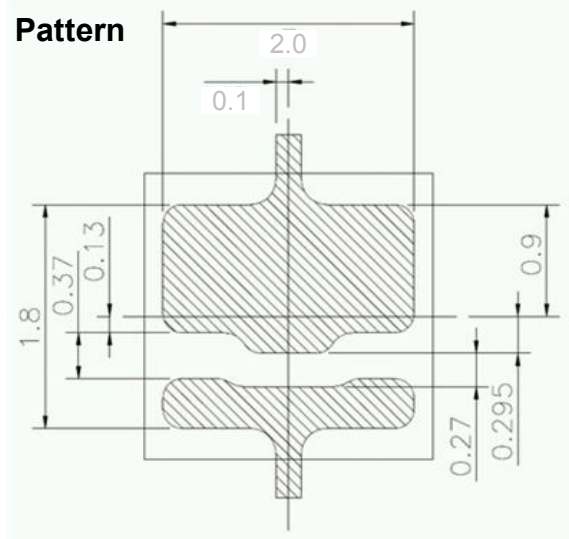

Notes:

- 1) This LED has built-in ESD protection device(s) connected in parallel to LED Chip(s).
- 2) Ts point & measurement method
 - ① Measure the nearest point to the thermal pad. If necessary, remove PSR of PCB to reach Ts point.
 - ② Thermal pad must be soldered to the PCB to dissipate heat properly. Otherwise, LED can be damaged.
- 3) Precautions
 - ① The pressure on the LEDs will influence to the reliability of the LEDs. Precautions should be taken to avoid the strong pressure on the LEDs. Do not put stress on the LEDs during heating.
 - ② Re-soldering should not be done after the LEDs have been soldered. If re-soldering is unavoidable, LED's characteristics should be carefully checked before and after such repair.
 - ③ Do not stack assembled PCBs together. Since materials of LEDs is soft, abrasion between two PCB assembled with LED might cause catastrophic failure of the LEDs.

6. Reliability Test Items & Conditions

1) Test Items and Results

Test Item	Test Conditions	Test Hours/Cycles	Sample No	
MSL Test	125°C, 24hrs → 60°C, 60%RH, 120hrs → Peak 260±5°C, 220°C over time 60sec, 3 cycles	1 cycle	11	
Room Temperature Life Test	25°C±3°C, DC 150mA	1,000 hrs	22	
High Temperature Life Test	85°C±3°C, DC 150mA	1,000 hrs	22	
High Temperature Humidity Life Test	85°C±3°C, 85%±2%RH, DC 150mA	1,000 hrs	22	
Low Temperature Life Test	-40°C±3°C, DC 150mA	1,000 hrs	22	
Powered Temperature Cycle Test	-45°C/20min ↔ 85°C/20min, Sweep 100min cycle on/off: each 5min, DC 150mA	100 cycles	22	
Thermal Shock	-45°C/15min ↔ 125°C/15min, → Hot plate 180°C	500 cycles	100	
High Temperature Storage	Ta=120°C±3°C	1,000 hrs	11	
Low Temperature Storage	Ta=-40°C±3°C	1,000 hrs	11	
ESD(HBM)		R1 : 10MΩ, R2 : 1.5KΩ, C : 100pF, V = ±5kV	5 times	5
ESD(MM)		R1 : 10MΩ, R2 : 0, C : 200pF, V = ±0.5kV	5 times	5
Vibration Test	20~2000~20 Hz 200 m/s ² , Sweep 4 min X, Y, Z 3 direction, each 1 cycle	4 cycles	11	
Mechanical Shock Test	1500G, 0.5ms, 3 shocks each X-Y-Z axis	5 cycles	11	

2) Criteria for Judging the Damage

Item	Symbol	Test Condition	Limit	
			Min	Max
Forward Voltage	V _F	I _F = 65 mA	Init. Value*0.9	Init. Value*1.1
Luminous Flux	Φ _v	I _F = 65 mA	Init. Value*0.7	Init. Value*1.1

7. Solder Conditions

1) Reflow Conditions (Pb Free)

Reflow Frequency : 2 times max.

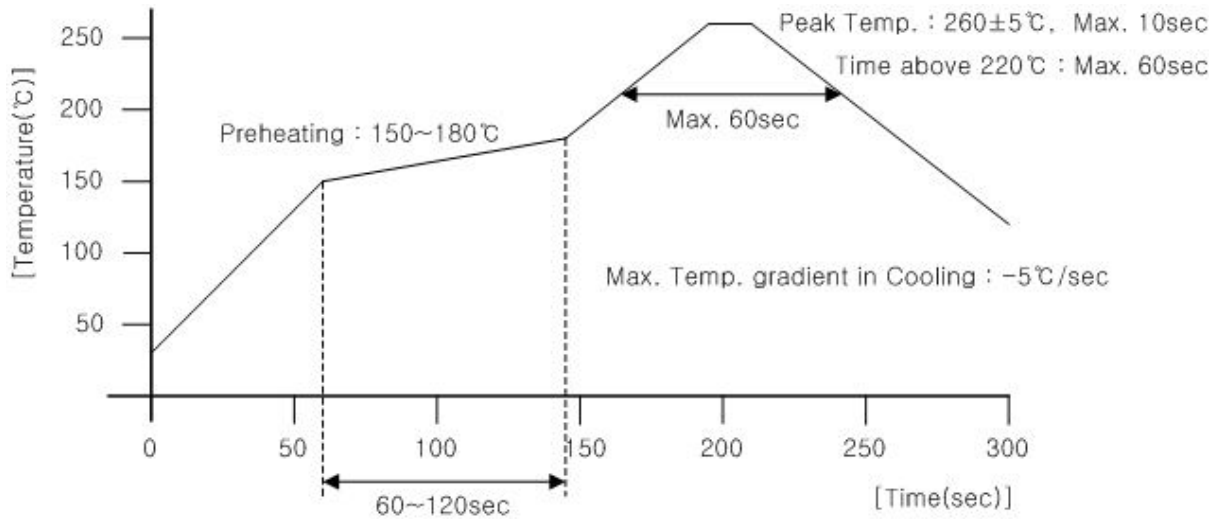

2) For Manual Soldering

Not more than 5 seconds @Max. 300°C, under soldering iron.

8. Tape & Reel

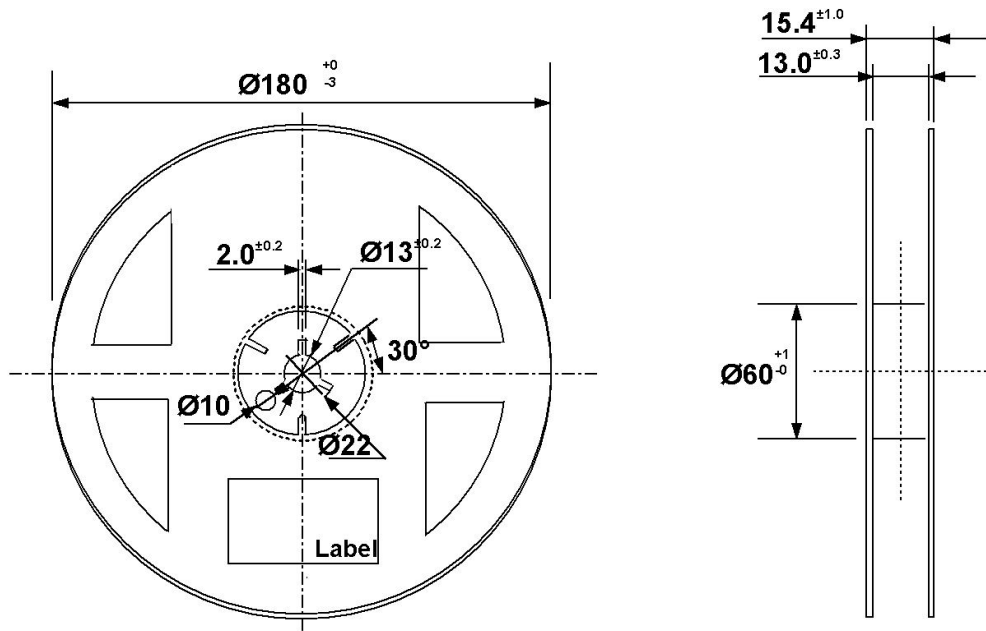
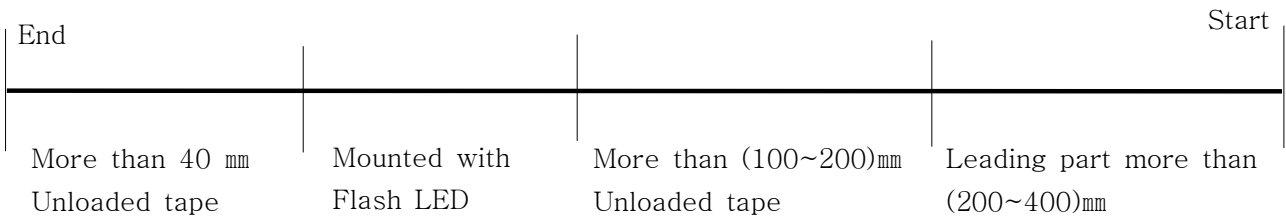
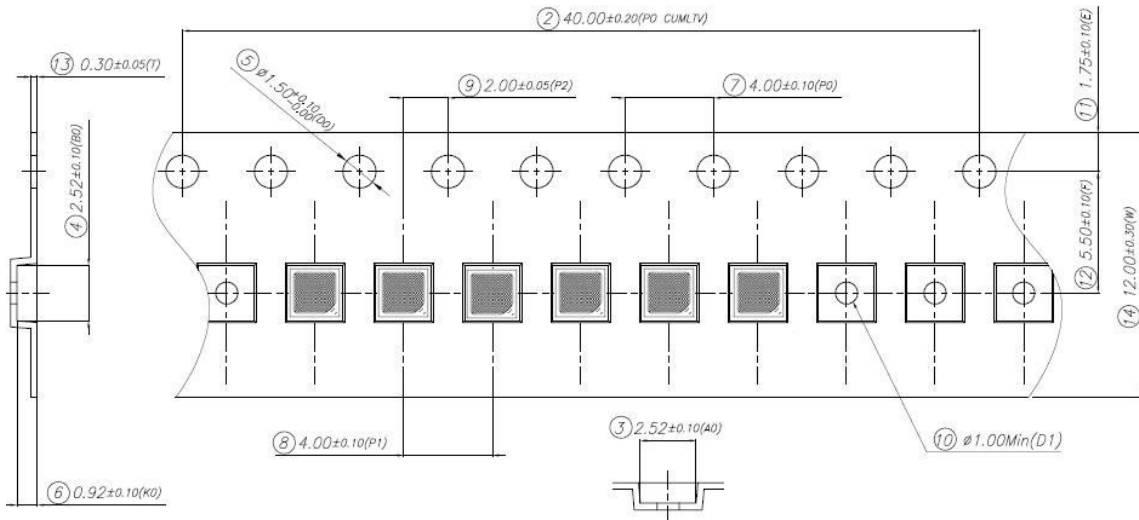

Tolerance ± 0.2 , Unit:mm

- (1) Quantity : The quantity/reel to be 4,000 pcs.
- (2) Cumulative Tolerance : Cumulative tolerance/10 pitches to be ± 0.2 mm
- (3) Adhesion Strength of Cover Tape : Adhesion strength to be 0.1-0.7 N when the cover tape is turned off from the carrier tape at 10 °C angle to be the carrier tape.
- (4) Packaging : P/N, Manufacturing data code no. and quantity to be indicated on a damp proof package.

9. Label Structure

1) Label Structure

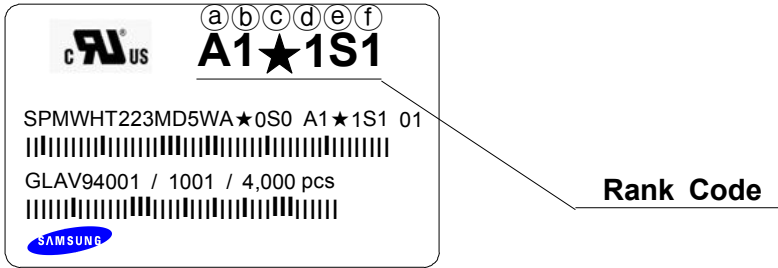

N.B) Denoted rank is the only example.

'★' means All kind of Chromaticity Coordinate Rank.

Rank Code

- ⒶⒷ : Forward Voltage(V_F) Rank (refer to page. 12)
- ⒸⒹ : Chromaticity Coordinate Rank (refer to page. 7~9)
- ⒺⒻ : Luminous Intensity(cd) Rank (refer to page. 3)

2) LOT Number

The Lot number is composed of the following characters

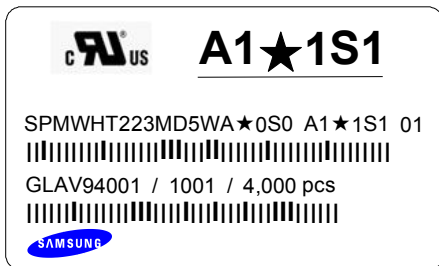

①②③④⑤⑥⑦⑧⑨ / 1ⒶⒷⒸ / 4,000 PCS

- ① : Production Site (S:SAMSUNG ELECTRONICS, G:GOSIN CHINA)
- ② : L (LED)
- ③ : Product State (A:Normality, B:Bulk, C:First Production, R:Reproduction, S:Sample)
- ④ : Year (V:2011, W:2012, X:2013...)
- ⑤ : Month (1 ~ 9, A, B)
- ⑥ : Day (1 ~ 9, A, B ~ V)
- ⑦⑧⑨ : SAMSUNG ELECTRONICS LED Product number (1 ~ 999)
- ⒶⒷⒸ : Reel Number (1 ~ 999)



10. Packing Structure

1) Packing Process

Reel

A1★1S1
 SPMWHT223MD5WA★0S0 A1★1S1 01
 GLAV94001 / 1001 / 4,000 pcs

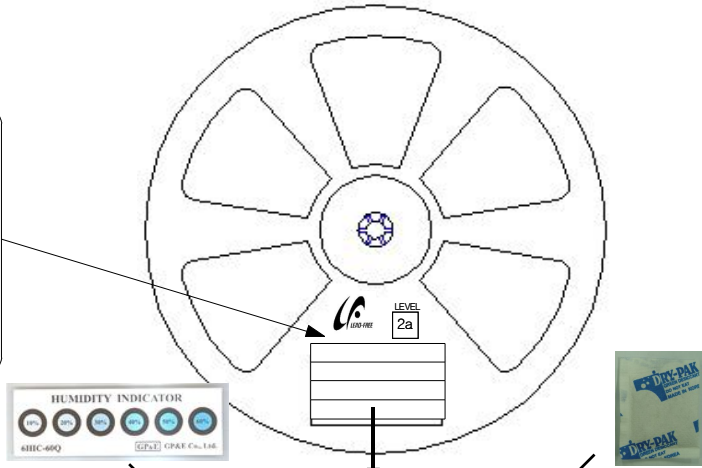

Aluminum Vinyl Bag

A1★1S1
 SPMWHT223MD5WA★0S0 A1★1S1 01
 GLAV94001 / 1001 / 4,000 pcs

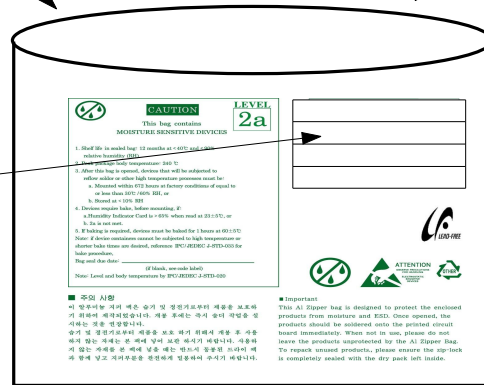

Material : Paper(SW3B(B))

TYPE	SIZE(mm)		
	L	W	H
7inch	245	220	182

① SIDE

A1★1S1
 SPMWHT223MD5WA★0S0 A1★1S1 01
 GLAV94001 / 1001 / 40,000 pcs
 [Box Label]

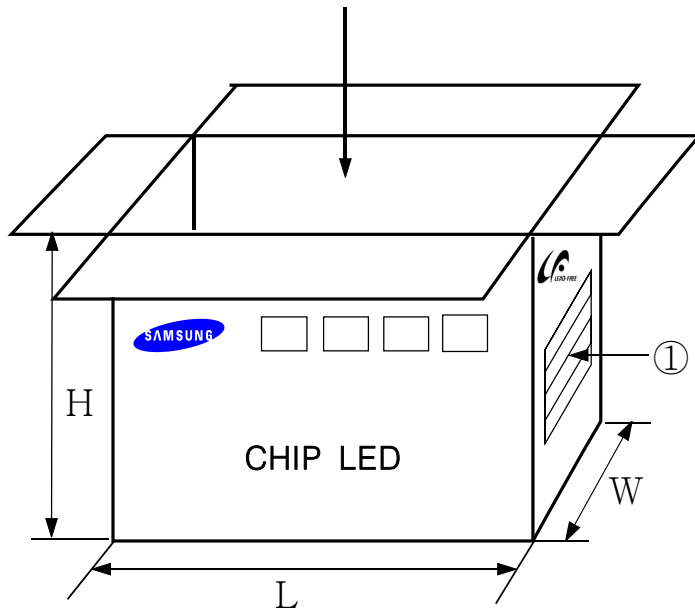

2) Aluminum Packing Bag



CAUTION

This bag contains
MOISTURE SENSITIVE DEVICES

LEVEL

2a

1. Shelf life in sealed bag: 12 months at <math>< 40^{\circ}\text{C}</math> and <math>< 90\%</math> relative humidity (RH)
2. Peak package body temperature: 240 °C
3. After this bag is opened, devices that will be subjected to reflow solder or other high temperature processes must be:
 - a. Mounted within 672 hours at factory conditions of equal to or less than 30°C / 60% RH, or
 - b. Stored at <math>< 10\%</math> RH
4. Devices require bake, before mounting, if:
 - a. Humidity Indicator Card is > 65% when read at 23±5°C, or
 - b. 2a is not met.
5. If baking is required, devices must be baked for 1 hours at 60±5°C

Note: if device containers cannot be subjected to high temperature or shorter bake times are desired, reference IPC/JEDEC J-STD-033 for bake procedure,

Bag seal due date: _____
(if blank, see code label)

Note: Level and body temperature by IPC/JEDEC J-STD-020





A1★1S1

SPMWHT223MD5WA★0S0 A1★1S1 01

GLAV94001 / 1001 / 4,000 pcs







■ 주의 사항

이 알루미늄 지퍼 백은 습기 및 정전기로부터 제품을 보호하기 위하여 제작되었습니다. 개봉 후에는 즉시 솔더 작업을 실시하는 것을 권장합니다.

습기 및 정전기로부터 제품을 보호 하기 위해서 개봉 후 사용하지 않는 자재는 본 팩에 넣어 보관 하시기 바랍니다. 사용하지 않는 자재를 본 팩에 넣을 때는 반드시 동봉된 드라이 팩과 함께 넣고 지퍼부분을 완전하게 밀봉하여 주시기 바랍니다.

■ Important

This Al Zipper bag is designed to protect the enclosed products from moisture and ESD. Once opened, the products should be soldered onto the printed circuit board immediately. When not in use, please do not leave the products unprotected by the Al Zipper Bag. To repack unused products., please ensure the zip-lock is completely sealed with the dry pack left inside.

Silica gel & Humidity Indicator Card in Aluminum Vinyl Bag

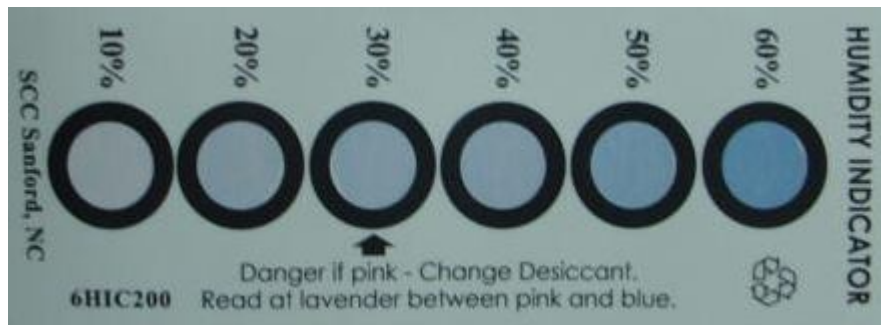

11. Kitting Rule

1) Kitting bin Concept – 2700K, 3000K, 3500K and 4000K

1. This item is included to ☆K models.
2. Under agreement between customer and SAMSUNG ELECTRONICS, SAMSUNG can supply kitting bin(V_F , Color, lm).
3. A forward voltage(V_F) of kitting bin is combined by a pair of same V_F rank such as (A1+A1), (A2+A2), (A3+A3), (A4+A4) or (AZ+AZ).
4. A Chromaticity Coordinates of kitting bin is mixed by kitting procedure.(below kitting simulation)
Especially, one of 1, 2, 3, or 4 rank can be mixed with other rank, or can be used alone.
5. A luminous flux(lm) is average by kitting procedure.(below kitting simulation)
For example Kitting lm is average S1 and S2 [Kitting $lm = (S1+S2)/2$]
6. '□' means one of the W(2700K), V(3000K), U(3500K) and T(4000K) a segment of the CCT rank.

[Kitting example]

Target

D	E	F	G
9	A	B	C
5	6	7	8
1	2	3	4

User can get the green box position by kitting combination.

Kitting Combination : +

D	E	F	G	D	E	F	G
9	A	B	C	9	A	B	C
5	6	7	8	5	6	7	8
1	2	3	4	1	2	3	4

D	E	F	G	D	E	F	G
9	A	B	C	9	A	B	C
5	6	7	8	5	6	7	8
1	2	3	4	1	2	3	4

D	E	F	G	D	E	F	G
9	A	B	C	9	A	B	C
5	6	7	8	5	6	7	8
1	2	3	4	1	2	3	4

D	E	F	G	D	E	F	G
9	A	B	C	9	A	B	C
5	6	7	8	5	6	7	8
1	2	3	4	1	2	3	4

D	E	F	G	D	E	F	G
9	A	B	C	9	A	B	C
5	6	7	8	5	6	7	8
1	2	3	4	1	2	3	4

D	E	F	G	D	E	F	G
9	A	B	C	9	A	B	C
5	6	7	8	5	6	7	8
1	2	3	4	1	2	3	4

D	E	F	G	D	E	F	G
9	A	B	C	9	A	B	C
5	6	7	8	5	6	7	8
1	2	3	4	1	2	3	4

D	E	F	G	D	E	F	G
9	A	B	C	9	A	B	C
5	6	7	8	5	6	7	8
1	2	3	4	1	2	3	4

D	E	F	G	D	E	F	G
9	A	B	C	9	A	B	C
5	6	7	8	5	6	7	8
1	2	3	4	1	2	3	4

D	E	F	G	D	E	F	G
9	A	B	C	9	A	B	C
5	6	7	8	5	6	7	8
1	2	3	4	1	2	3	4

D	E	F	G	D	E	F	G
9	A	B	C	9	A	B	C
5	6	7	8	5	6	7	8
1	2	3	4	1	2	3	4

D	E	F	G	D	E	F	G
9	A	B	C	9	A	B	C
5	6	7	8	5	6	7	8
1	2	3	4	1	2	3	4



[Kitting combination – 2700K, 3000K, 3500K and 4000K]

-	RANK 1	RANK 2	RANK 1	RANK 2	RANK 1	RANK 2	RANK 1	RANK 2	RANK 1	RANK 2	RANK 1	RANK 2
1	A3□7S1	A3□7S1	A4□BS1	A4□BS1								
2	A3□7S1	A3□7S2	A4□BS1	A4□BS2								
3	A3□7S1	A3□7S3	A4□BS1	A4□BS3								
4	A3□7S2	A3□7S1	A4□BS2	A4□BS1								
5	A3□7S2	A3□7S2	A4□BS2	A4□BS2								
6	A3□7S2	A3□7S3	A4□BS2	A4□BS3								
7	A3□7S3	A3□7S1	A4□BS3	A4□BS1								
8	A3□7S3	A3□7S2	A4□BS3	A4□BS2								
9	A3□7S3	A3□7S3	A4□BS3	A4□BS3								
10	A4□7S1	A4□7S1	AZ□BS1	AZ□BS1								
11	A4□7S1	A4□7S2	AZ□BS1	AZ□BS2								
12	A4□7S1	A4□7S3	AZ□BS1	AZ□BS3								
13	A4□7S2	A4□7S1	AZ□BS2	AZ□BS1								
14	A4□7S2	A4□7S2	AZ□BS2	AZ□BS2								
15	A4□7S2	A4□7S3	AZ□BS2	AZ□BS3								
16	A4□7S3	A4□7S1	AZ□BS3	AZ□BS1								
17	A4□7S3	A4□7S2	AZ□BS3	AZ□BS2								
18	A4□7S3	A4□7S3	AZ□BS3	AZ□BS3								
19	AZ□7S1	AZ□7S1										
20	AZ□7S1	AZ□7S2										
21	AZ□7S1	AZ□7S3										
22	AZ□7S2	AZ□7S1										
23	AZ□7S2	AZ□7S2										
24	AZ□7S2	AZ□7S3										
25	AZ□7S3	AZ□7S1										
26	AZ□7S3	AZ□7S2										
27	AZ□7S3	AZ□7S3										
28	A1□BS1	A1□BS1										
29	A1□BS1	A1□BS2										
30	A1□BS1	A1□BS3										
31	A1□BS2	A1□BS1										
32	A1□BS2	A1□BS2										
33	A1□BS2	A1□BS3										
34	A1□BS3	A1□BS1										
35	A1□BS3	A1□BS2										
36	A1□BS3	A1□BS3										
37	A2□BS1	A2□BS1										
38	A2□BS1	A2□BS2										
39	A2□BS1	A2□BS3										
40	A2□BS2	A2□BS1										
41	A2□BS2	A2□BS2										
42	A2□BS2	A2□BS3										
43	A2□BS3	A2□BS1										
44	A2□BS3	A2□BS2										
45	A2□BS3	A2□BS3										
46	A3□BS1	A3□BS1										
47	A3□BS1	A3□BS2										
48	A3□BS1	A3□BS3										
49	A3□BS2	A3□BS1										
50	A3□BS2	A3□BS2										
51	A3□BS2	A3□BS3										
52	A3□BS3	A3□BS1										
53	A3□BS3	A3□BS2										
54	A3□BS3	A3□BS3										

2) Kitting bin Concept – 5000K, 5700K and 6500K

1. This item is included to ☆K models.
2. Under agreement between customer and SAMSUNG ELECTRONICS, SAMSUNG can supply kitting bin(V_F , Color, lm).
3. A forward voltage(V_F) of kitting bin is combined by a pair of same V_F rank such as (A1+A1), (A2+A2), (A3+A3), (A4+A4) or (AZ+AZ).
4. A Chromaticity Coordinates of kitting bin is mixed by kitting procedure.(below kitting simulation) Especially, one of 1, 2, 3, or 4 rank can be mixed with other rank, or can be used alone.
5. A luminous flux(lm) is average by kitting procedure.(below kitting simulation)
For example Kitting lm is average S1 and S2 [Kitting lm = $(S1+S2)/2$]
6. 'O' means one of the R(5000K), Q(5700K) and P(6500K) a segment of the CCT rank.

[Kitting example]

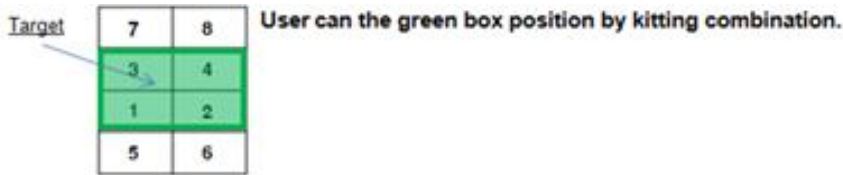

Kitting Combination :  + 

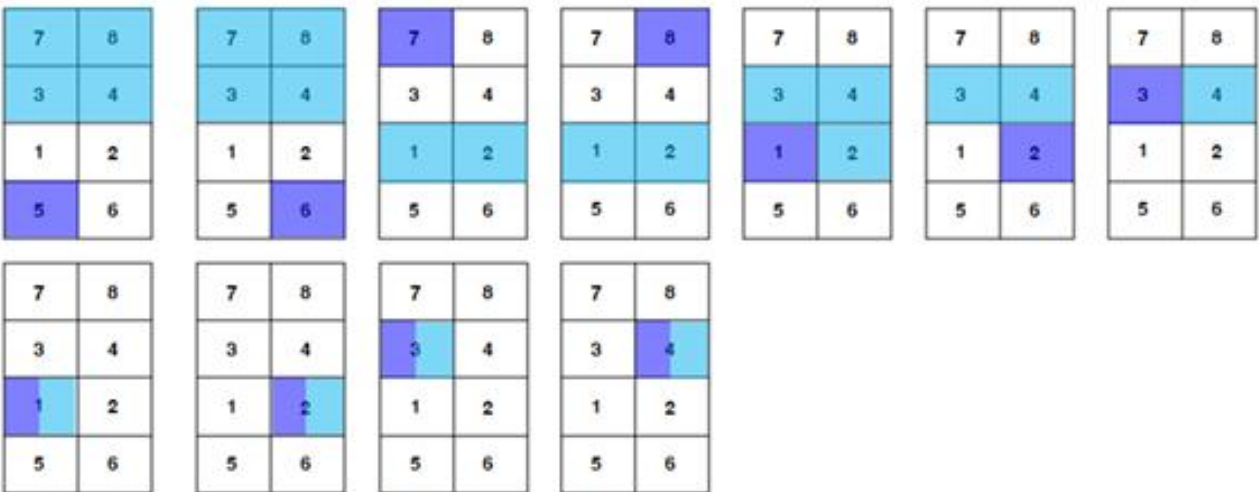



[Kitting combination – 5000K, 5700K and 6500K]

-	RANK 1	RANK 2	RANK 1	RANK 2	RANK 1	RANK 2	RANK 1	RANK 2	RANK 1	RANK 2	RANK 1	RANK 2
1	A1O5S1	A1O7S1	A2O5S1	A2O8S1	A3O5S1	A3O3S1	A4O5S1	A4O4S1	AZO6S1	AZO7S1	A1O6S1	A1O8S1
2	A1O5S1	A1O7S2	A2O5S1	A2O8S2	A3O5S1	A3O3S2	A4O5S1	A4O4S2	AZO6S1	AZO7S2	A1O6S1	A1O8S2
3	A1O5S1	A1O7S3	A2O5S1	A2O8S3	A3O5S1	A3O3S3	A4O5S1	A4O4S3	AZO6S1	AZO7S3	A1O6S1	A1O8S3
4	A1O5S2	A1O7S1	A2O5S2	A2O8S1	A3O5S2	A3O3S1	A4O5S2	A4O4S1	AZO6S2	AZO7S1	A1O6S2	A1O8S1
5	A1O5S2	A1O7S2	A2O5S2	A2O8S2	A3O5S2	A3O3S2	A4O5S2	A4O4S2	AZO6S2	AZO7S2	A1O6S2	A1O8S2
6	A1O5S2	A1O7S3	A2O5S2	A2O8S3	A3O5S2	A3O3S3	A4O5S2	A4O4S3	AZO6S2	AZO7S3	A1O6S2	A1O8S3
7	A1O5S3	A1O7S1	A2O5S3	A2O8S1	A3O5S3	A3O3S1	A4O5S3	A4O4S1	AZO6S3	AZO7S1	A1O6S3	A1O8S1
8	A1O5S3	A1O7S2	A2O5S3	A2O8S2	A3O5S3	A3O3S2	A4O5S3	A4O4S2	AZO6S3	AZO7S2	A1O6S3	A1O8S2
9	A1O5S3	A1O7S3	A2O5S3	A2O8S3	A3O5S3	A3O3S3	A4O5S3	A4O4S3	AZO6S3	AZO7S3	A1O6S3	A1O8S3
10	A2O5S1	A2O7S1	A3O5S1	A3O8S1	A4O5S1	A4O3S1	AZO5S1	AZO4S1	A1O6S1	A1O3S1	A2O6S1	A2O8S1
11	A2O5S1	A2O7S2	A3O5S1	A3O8S2	A4O5S1	A4O3S2	AZO5S1	AZO4S2	A1O6S1	A1O3S2	A2O6S1	A2O8S2
12	A2O5S1	A2O7S3	A3O5S1	A3O8S3	A4O5S1	A4O3S3	AZO5S1	AZO4S3	A1O6S1	A1O3S3	A2O6S1	A2O8S3
13	A2O5S2	A2O7S1	A3O5S2	A3O8S1	A4O5S2	A4O3S1	AZO5S2	AZO4S1	A1O6S2	A1O3S1	A2O6S2	A2O8S1
14	A2O5S2	A2O7S2	A3O5S2	A3O8S2	A4O5S2	A4O3S2	AZO5S2	AZO4S2	A1O6S2	A1O3S2	A2O6S2	A2O8S2
15	A2O5S2	A2O7S3	A3O5S2	A3O8S3	A4O5S2	A4O3S3	AZO5S2	AZO4S3	A1O6S2	A1O3S3	A2O6S2	A2O8S3
16	A2O5S3	A2O7S1	A3O5S3	A3O8S1	A4O5S3	A4O3S1	AZO5S3	AZO4S1	A1O6S3	A1O3S1	A2O6S3	A2O8S1
17	A2O5S3	A2O7S2	A3O5S3	A3O8S2	A4O5S3	A4O3S2	AZO5S3	AZO4S2	A1O6S3	A1O3S2	A2O6S3	A2O8S2
18	A2O5S3	A2O7S3	A3O5S3	A3O8S3	A4O5S3	A4O3S3	AZO5S3	AZO4S3	A1O6S3	A1O3S3	A2O6S3	A2O8S3
19	A3O5S1	A3O7S1	A4O5S1	A4O8S1	AZO5S1	AZO3S1	A1O6S1	A1O7S1	A2O6S1	A2O3S1	A3O6S1	A3O8S1
20	A3O5S1	A3O7S2	A4O5S1	A4O8S2	AZO5S1	AZO3S2	A1O6S1	A1O7S2	A2O6S1	A2O3S2	A3O6S1	A3O8S2
21	A3O5S1	A3O7S3	A4O5S1	A4O8S3	AZO5S1	AZO3S3	A1O6S1	A1O7S3	A2O6S1	A2O3S3	A3O6S1	A3O8S3
22	A3O5S2	A3O7S1	A4O5S2	A4O8S1	AZO5S2	AZO3S1	A1O6S2	A1O7S1	A2O6S2	A2O3S1	A3O6S2	A3O8S1
23	A3O5S2	A3O7S2	A4O5S2	A4O8S2	AZO5S2	AZO3S2	A1O6S2	A1O7S2	A2O6S2	A2O3S2	A3O6S2	A3O8S2
24	A3O5S2	A3O7S3	A4O5S2	A4O8S3	AZO5S2	AZO3S3	A1O6S2	A1O7S3	A2O6S2	A2O3S3	A3O6S2	A3O8S3
25	A3O5S3	A3O7S1	A4O5S3	A4O8S1	AZO5S3	AZO3S1	A1O6S3	A1O7S1	A2O6S3	A2O3S1	A3O6S3	A3O8S1
26	A3O5S3	A3O7S2	A4O5S3	A4O8S2	AZO5S3	AZO3S2	A1O6S3	A1O7S2	A2O6S3	A2O3S2	A3O6S3	A3O8S2
27	A3O5S3	A3O7S3	A4O5S3	A4O8S3	AZO5S3	AZO3S3	A1O6S3	A1O7S3	A2O6S3	A2O3S3	A3O6S3	A3O8S3
28	A4O5S1	A4O7S1	AZO5S1	AZO8S1	A1O5S1	A1O4S1	A2O6S1	A2O7S1	A3O6S1	A3O3S1	A4O6S1	A4O8S1
29	A4O5S1	A4O7S2	AZO5S1	AZO8S2	A1O5S1	A1O4S2	A2O6S1	A2O7S2	A3O6S1	A3O3S2	A4O6S1	A4O8S2
30	A4O5S1	A4O7S3	AZO5S1	AZO8S3	A1O5S1	A1O4S3	A2O6S1	A2O7S3	A3O6S1	A3O3S3	A4O6S1	A4O8S3
31	A4O5S2	A4O7S1	AZO5S2	AZO8S1	A1O5S2	A1O4S1	A2O6S2	A2O7S1	A3O6S2	A3O3S1	A4O6S2	A4O8S1
32	A4O5S2	A4O7S2	AZO5S2	AZO8S2	A1O5S2	A1O4S2	A2O6S2	A2O7S2	A3O6S2	A3O3S2	A4O6S2	A4O8S2
33	A4O5S2	A4O7S3	AZO5S2	AZO8S3	A1O5S2	A1O4S3	A2O6S2	A2O7S3	A3O6S2	A3O3S3	A4O6S2	A4O8S3
34	A4O5S3	A4O7S1	AZO5S3	AZO8S1	A1O5S3	A1O4S1	A2O6S3	A2O7S1	A3O6S3	A3O3S1	A4O6S3	A4O8S1
35	A4O5S3	A4O7S2	AZO5S3	AZO8S2	A1O5S3	A1O4S2	A2O6S3	A2O7S2	A3O6S3	A3O3S2	A4O6S3	A4O8S2
36	A4O5S3	A4O7S3	AZO5S3	AZO8S3	A1O5S3	A1O4S3	A2O6S3	A2O7S3	A3O6S3	A3O3S3	A4O6S3	A4O8S3
37	AZO5S1	AZO7S1	A1O5S1	A1O3S1	A2O5S1	A2O4S1	A3O6S1	A3O7S1	A4O6S1	A4O3S1	AZO6S1	AZO8S1
38	AZO5S1	AZO7S2	A1O5S1	A1O3S2	A2O5S1	A2O4S2	A3O6S1	A3O7S2	A4O6S1	A4O3S2	AZO6S1	AZO8S2
39	AZO5S1	AZO7S3	A1O5S1	A1O3S3	A2O5S1	A2O4S3	A3O6S1	A3O7S3	A4O6S1	A4O3S3	AZO6S1	AZO8S3
40	AZO5S2	AZO7S1	A1O5S2	A1O3S1	A2O5S2	A2O4S1	A3O6S2	A3O7S1	A4O6S2	A4O3S1	AZO6S2	AZO8S1
41	AZO5S2	AZO7S2	A1O5S2	A1O3S2	A2O5S2	A2O4S2	A3O6S2	A3O7S2	A4O6S2	A4O3S2	AZO6S2	AZO8S2
42	AZO5S2	AZO7S3	A1O5S2	A1O3S3	A2O5S2	A2O4S3	A3O6S2	A3O7S3	A4O6S2	A4O3S3	AZO6S2	AZO8S3
43	AZO5S3	AZO7S1	A1O5S3	A1O3S1	A2O5S3	A2O4S1	A3O6S3	A3O7S1	A4O6S3	A4O3S1	AZO6S3	AZO8S1
44	AZO5S3	AZO7S2	A1O5S3	A1O3S2	A2O5S3	A2O4S2	A3O6S3	A3O7S2	A4O6S3	A4O3S2	AZO6S3	AZO8S2
45	AZO5S3	AZO7S3	A1O5S3	A1O3S3	A2O5S3	A2O4S3	A3O6S3	A3O7S3	A4O6S3	A4O3S3	AZO6S3	AZO8S3
46	A1O5S1	A1O8S1	A2O5S1	A2O3S1	A3O5S1	A3O4S1	A4O6S1	A4O7S1	AZO6S1	AZO3S1	A1O6S1	A1O4S1
47	A1O5S1	A1O8S2	A2O5S1	A2O3S2	A3O5S1	A3O4S2	A4O6S1	A4O7S2	AZO6S1	AZO3S2	A1O6S1	A1O4S2
48	A1O5S1	A1O8S3	A2O5S1	A2O3S3	A3O5S1	A3O4S3	A4O6S1	A4O7S3	AZO6S1	AZO3S3	A1O6S1	A1O4S3
49	A1O5S2	A1O8S1	A2O5S2	A2O3S1	A3O5S2	A3O4S1	A4O6S2	A4O7S1	AZO6S2	AZO3S1	A1O6S2	A1O4S1
50	A1O5S2	A1O8S2	A2O5S2	A2O3S2	A3O5S2	A3O4S2	A4O6S2	A4O7S2	AZO6S2	AZO3S2	A1O6S2	A1O4S2
51	A1O5S2	A1O8S3	A2O5S2	A2O3S3	A3O5S2	A3O4S3	A4O6S2	A4O7S3	AZO6S2	AZO3S3	A1O6S2	A1O4S3
52	A1O5S3	A1O8S1	A2O5S3	A2O3S1	A3O5S3	A3O4S1	A4O6S3	A4O7S1	AZO6S3	AZO3S1	A1O6S3	A1O4S1
53	A1O5S3	A1O8S2	A2O5S3	A2O3S2	A3O5S3	A3O4S2	A4O6S3	A4O7S2	AZO6S3	AZO3S2	A1O6S3	A1O4S2
54	A1O5S3	A1O8S3	A2O5S3	A2O3S3	A3O5S3	A3O4S3	A4O6S3	A4O7S3	AZO6S3	AZO3S3	A1O6S3	A1O4S3



[Kitting combination – 5000K, 5700K and 6500K]

-	RANK 1	RANK 2	RANK 1	RANK 2	RANK 1	RANK 2	RANK 1	RANK 2	RANK 1	RANK 2	RANK 1	RANK 2
1	A2O6S1	A2O4S1	A3O7S1	A3O1S1	A4O7S1	A4O2S1	AZO8S1	AZO1S1	A1O1S1	A1O2S1	A2O1S1	A2O3S1
2	A2O6S1	A2O4S2	A3O7S1	A3O1S2	A4O7S1	A4O2S2	AZO8S1	AZO1S2	A1O1S1	A1O2S2	A2O1S1	A2O3S2
3	A2O6S1	A2O4S3	A3O7S1	A3O1S3	A4O7S1	A4O2S3	AZO8S1	AZO1S3	A1O1S1	A1O2S3	A2O1S1	A2O3S3
4	A2O6S2	A2O4S1	A3O7S2	A3O1S1	A4O7S2	A4O2S1	AZO8S2	AZO1S1	A1O1S2	A1O2S1	A2O1S2	A2O3S1
5	A2O6S2	A2O4S2	A3O7S2	A3O1S2	A4O7S2	A4O2S2	AZO8S2	AZO1S2	A1O1S2	A1O2S2	A2O1S2	A2O3S2
6	A2O6S2	A2O4S3	A3O7S2	A3O1S3	A4O7S2	A4O2S3	AZO8S2	AZO1S3	A1O1S2	A1O2S3	A2O1S2	A2O3S3
7	A2O6S3	A2O4S1	A3O7S3	A3O1S1	A4O7S3	A4O2S1	AZO8S3	AZO1S1	A1O1S3	A1O2S1	A2O1S3	A2O3S1
8	A2O6S3	A2O4S2	A3O7S3	A3O1S2	A4O7S3	A4O2S2	AZO8S3	AZO1S2	A1O1S3	A1O2S2	A2O1S3	A2O3S2
9	A2O6S3	A2O4S3	A3O7S3	A3O1S3	A4O7S3	A4O2S3	AZO8S3	AZO1S3	A1O1S3	A1O2S3	A2O1S3	A2O3S3
10	A3O6S1	A3O4S1	A4O7S1	A4O1S1	AZO7S1	AZO2S1	A1O8S1	A1O2S1	A2O1S1	A2O2S1	A3O1S1	A3O3S1
11	A3O6S1	A3O4S2	A4O7S1	A4O1S2	AZO7S1	AZO2S2	A1O8S1	A1O2S2	A2O1S1	A2O2S2	A3O1S1	A3O3S2
12	A3O6S1	A3O4S3	A4O7S1	A4O1S3	AZO7S1	AZO2S3	A1O8S1	A1O2S3	A2O1S1	A2O2S3	A3O1S1	A3O3S3
13	A3O6S2	A3O4S1	A4O7S2	A4O1S1	AZO7S2	AZO2S1	A1O8S2	A1O2S1	A2O1S2	A2O2S1	A3O1S2	A3O3S1
14	A3O6S2	A3O4S2	A4O7S2	A4O1S2	AZO7S2	AZO2S2	A1O8S2	A1O2S2	A2O1S2	A2O2S2	A3O1S2	A3O3S2
15	A3O6S2	A3O4S3	A4O7S2	A4O1S3	AZO7S2	AZO2S3	A1O8S2	A1O2S3	A2O1S2	A2O2S3	A3O1S2	A3O3S3
16	A3O6S3	A3O4S1	A4O7S3	A4O1S1	AZO7S3	AZO2S1	A1O8S3	A1O2S1	A2O1S3	A2O2S1	A3O1S3	A3O3S1
17	A3O6S3	A3O4S2	A4O7S3	A4O1S2	AZO7S3	AZO2S2	A1O8S3	A1O2S2	A2O1S3	A2O2S2	A3O1S3	A3O3S2
18	A3O6S3	A3O4S3	A4O7S3	A4O1S3	AZO7S3	AZO2S3	A1O8S3	A1O2S3	A2O1S3	A2O2S3	A3O1S3	A3O3S3
19	A4O6S1	A4O4S1	AZO7S1	AZO1S1	A1O8S1	A1O1S1	A2O8S1	A2O2S1	A3O1S1	A3O2S1	A4O1S1	A4O3S1
20	A4O6S1	A4O4S2	AZO7S1	AZO1S2	A1O8S1	A1O1S2	A2O8S1	A2O2S2	A3O1S1	A3O2S2	A4O1S1	A4O3S2
21	A4O6S1	A4O4S3	AZO7S1	AZO1S3	A1O8S1	A1O1S3	A2O8S1	A2O2S3	A3O1S1	A3O2S3	A4O1S1	A4O3S3
22	A4O6S2	A4O4S1	AZO7S2	AZO1S1	A1O8S2	A1O1S1	A2O8S2	A2O2S1	A3O1S2	A3O2S1	A4O1S2	A4O3S1
23	A4O6S2	A4O4S2	AZO7S2	AZO1S2	A1O8S2	A1O1S2	A2O8S2	A2O2S2	A3O1S2	A3O2S2	A4O1S2	A4O3S2
24	A4O6S2	A4O4S3	AZO7S2	AZO1S3	A1O8S2	A1O1S3	A2O8S2	A2O2S3	A3O1S2	A3O2S3	A4O1S2	A4O3S3
25	A4O6S3	A4O4S1	AZO7S3	AZO1S1	A1O8S3	A1O1S1	A2O8S3	A2O2S1	A3O1S3	A3O2S1	A4O1S3	A4O3S1
26	A4O6S3	A4O4S2	AZO7S3	AZO1S2	A1O8S3	A1O1S2	A2O8S3	A2O2S2	A3O1S3	A3O2S2	A4O1S3	A4O3S2
27	A4O6S3	A4O4S3	AZO7S3	AZO1S3	A1O8S3	A1O1S3	A2O8S3	A2O2S3	A3O1S3	A3O2S3	A4O1S3	A4O3S3
28	AZO6S1	AZO4S1	A1O7S1	A1O2S1	A2O8S1	A2O1S1	A3O8S1	A3O2S1	A4O1S1	A4O2S1	AZO1S1	AZO3S1
29	AZO6S1	AZO4S2	A1O7S1	A1O2S2	A2O8S1	A2O1S2	A3O8S1	A3O2S2	A4O1S1	A4O2S2	AZO1S1	AZO3S2
30	AZO6S1	AZO4S3	A1O7S1	A1O2S3	A2O8S1	A2O1S3	A3O8S1	A3O2S3	A4O1S1	A4O2S3	AZO1S1	AZO3S3
31	AZO6S2	AZO4S1	A1O7S2	A1O2S1	A2O8S2	A2O1S1	A3O8S2	A3O2S1	A4O1S2	A4O2S1	AZO1S2	AZO3S1
32	AZO6S2	AZO4S2	A1O7S2	A1O2S2	A2O8S2	A2O1S2	A3O8S2	A3O2S2	A4O1S2	A4O2S2	AZO1S2	AZO3S2
33	AZO6S2	AZO4S3	A1O7S2	A1O2S3	A2O8S2	A2O1S3	A3O8S2	A3O2S3	A4O1S2	A4O2S3	AZO1S2	AZO3S3
34	AZO6S3	AZO4S1	A1O7S3	A1O2S1	A2O8S3	A2O1S1	A3O8S3	A3O2S1	A4O1S3	A4O2S1	AZO1S3	AZO3S1
35	AZO6S3	AZO4S2	A1O7S3	A1O2S2	A2O8S3	A2O1S2	A3O8S3	A3O2S2	A4O1S3	A4O2S2	AZO1S3	AZO3S2
36	AZO6S3	AZO4S3	A1O7S3	A1O2S3	A2O8S3	A2O1S3	A3O8S3	A3O2S3	A4O1S3	A4O2S3	AZO1S3	AZO3S3
37	A1O7S1	A1O1S1	A2O7S1	A2O2S1	A3O8S1	A3O1S1	A4O8S1	A4O2S1	AZO1S1	AZO2S1	A1O1S1	A1O4S1
38	A1O7S1	A1O1S2	A2O7S1	A2O2S2	A3O8S1	A3O1S2	A4O8S1	A4O2S2	AZO1S1	AZO2S2	A1O1S1	A1O4S2
39	A1O7S1	A1O1S3	A2O7S1	A2O2S3	A3O8S1	A3O1S3	A4O8S1	A4O2S3	AZO1S1	AZO2S3	A1O1S1	A1O4S3
40	A1O7S2	A1O1S1	A2O7S2	A2O2S1	A3O8S2	A3O1S1	A4O8S2	A4O2S1	AZO1S2	AZO2S1	A1O1S2	A1O4S1
41	A1O7S2	A1O1S2	A2O7S2	A2O2S2	A3O8S2	A3O1S2	A4O8S2	A4O2S2	AZO1S2	AZO2S2	A1O1S2	A1O4S2
42	A1O7S2	A1O1S3	A2O7S2	A2O2S3	A3O8S2	A3O1S3	A4O8S2	A4O2S3	AZO1S2	AZO2S3	A1O1S2	A1O4S3
43	A1O7S3	A1O1S1	A2O7S3	A2O2S1	A3O8S3	A3O1S1	A4O8S3	A4O2S1	AZO1S3	AZO2S1	A1O1S3	A1O4S1
44	A1O7S3	A1O1S2	A2O7S3	A2O2S2	A3O8S3	A3O1S2	A4O8S3	A4O2S2	AZO1S3	AZO2S2	A1O1S3	A1O4S2
45	A1O7S3	A1O1S3	A2O7S3	A2O2S3	A3O8S3	A3O1S3	A4O8S3	A4O2S3	AZO1S3	AZO2S3	A1O1S3	A1O4S3
46	A2O7S1	A2O1S1	A3O7S1	A3O2S1	A4O8S1	A4O1S1	AZO8S1	AZO2S1	A1O1S1	A1O3S1	A2O1S1	A2O4S1
47	A2O7S1	A2O1S2	A3O7S1	A3O2S2	A4O8S1	A4O1S2	AZO8S1	AZO2S2	A1O1S1	A1O3S2	A2O1S1	A2O4S2
48	A2O7S1	A2O1S3	A3O7S1	A3O2S3	A4O8S1	A4O1S3	AZO8S1	AZO2S3	A1O1S1	A1O3S3	A2O1S1	A2O4S3
49	A2O7S2	A2O1S1	A3O7S2	A3O2S1	A4O8S2	A4O1S1	AZO8S2	AZO2S1	A1O1S2	A1O3S1	A2O1S2	A2O4S1
50	A2O7S2	A2O1S2	A3O7S2	A3O2S2	A4O8S2	A4O1S2	AZO8S2	AZO2S2	A1O1S2	A1O3S2	A2O1S2	A2O4S2
51	A2O7S2	A2O1S3	A3O7S2	A3O2S3	A4O8S2	A4O1S3	AZO8S2	AZO2S3	A1O1S2	A1O3S3	A2O1S2	A2O4S3
52	A2O7S3	A2O1S1	A3O7S3	A3O2S1	A4O8S3	A4O1S1	AZO8S3	AZO2S1	A1O1S3	A1O3S1	A2O1S3	A2O4S1
53	A2O7S3	A2O1S2	A3O7S3	A3O2S2	A4O8S3	A4O1S2	AZO8S3	AZO2S2	A1O1S3	A1O3S2	A2O1S3	A2O4S2
54	A2O7S3	A2O1S3	A3O7S3	A3O2S3	A4O8S3	A4O1S3	AZO8S3	AZO2S3	A1O1S3	A1O3S3	A2O1S3	A2O4S3



[Kitting combination – 5000K, 5700K and 6500K]

-	RANK 1	RANK 2	RANK 1	RANK 2	RANK 1	RANK 2	RANK 1	RANK 2	RANK 1	RANK 2	RANK 1	RANK 2
1	A3O1S1	A3O4S1	A4O2S1	A4O3S1	AZO2S1	AZO4S1	A1O1S1	A1O1S1	A2O2S1	A2O2S1	A3O3S1	A3O3S1
2	A3O1S1	A3O4S2	A4O2S1	A4O3S2	AZO2S1	AZO4S2	A1O1S1	A1O1S2	A2O2S1	A2O2S2	A3O3S1	A3O3S2
3	A3O1S1	A3O4S3	A4O2S1	A4O3S3	AZO2S1	AZO4S3	A1O1S1	A1O1S3	A2O2S1	A2O2S3	A3O3S1	A3O3S3
4	A3O1S2	A3O4S1	A4O2S2	A4O3S1	AZO2S2	AZO4S1	A1O1S2	A1O1S1	A2O2S2	A2O2S1	A3O3S2	A3O3S1
5	A3O1S2	A3O4S2	A4O2S2	A4O3S2	AZO2S2	AZO4S2	A1O1S2	A1O1S2	A2O2S2	A2O2S2	A3O3S2	A3O3S2
6	A3O1S2	A3O4S3	A4O2S2	A4O3S3	AZO2S2	AZO4S3	A1O1S2	A1O1S3	A2O2S2	A2O2S3	A3O3S2	A3O3S3
7	A3O1S3	A3O4S1	A4O2S3	A4O3S1	AZO2S3	AZO4S1	A1O1S3	A1O1S1	A2O2S3	A2O2S1	A3O3S3	A3O3S1
8	A3O1S3	A3O4S2	A4O2S3	A4O3S2	AZO2S3	AZO4S2	A1O1S3	A1O1S2	A2O2S3	A2O2S2	A3O3S3	A3O3S2
9	A3O1S3	A3O4S3	A4O2S3	A4O3S3	AZO2S3	AZO4S3	A1O1S3	A1O1S3	A2O2S3	A2O2S3	A3O3S3	A3O3S3
10	A4O1S1	A4O4S1	AZO2S1	AZO3S1	A1O3S1	A1O4S1	A2O1S1	A2O1S1	A3O2S1	A3O2S1	A4O3S1	A4O3S1
11	A4O1S1	A4O4S2	AZO2S1	AZO3S2	A1O3S1	A1O4S2	A2O1S1	A2O1S2	A3O2S1	A3O2S2	A4O3S1	A4O3S2
12	A4O1S1	A4O4S3	AZO2S1	AZO3S3	A1O3S1	A1O4S3	A2O1S1	A2O1S3	A3O2S1	A3O2S3	A4O3S1	A4O3S3
13	A4O1S2	A4O4S1	AZO2S2	AZO3S1	A1O3S2	A1O4S1	A2O1S2	A2O1S1	A3O2S2	A3O2S1	A4O3S2	A4O3S1
14	A4O1S2	A4O4S2	AZO2S2	AZO3S2	A1O3S2	A1O4S2	A2O1S2	A2O1S2	A3O2S2	A3O2S2	A4O3S2	A4O3S2
15	A4O1S2	A4O4S3	AZO2S2	AZO3S3	A1O3S2	A1O4S3	A2O1S2	A2O1S3	A3O2S2	A3O2S3	A4O3S2	A4O3S3
16	A4O1S3	A4O4S1	AZO2S3	AZO3S1	A1O3S3	A1O4S1	A2O1S3	A2O1S1	A3O2S3	A3O2S1	A4O3S3	A4O3S1
17	A4O1S3	A4O4S2	AZO2S3	AZO3S2	A1O3S3	A1O4S2	A2O1S3	A2O1S2	A3O2S3	A3O2S2	A4O3S3	A4O3S2
18	A4O1S3	A4O4S3	AZO2S3	AZO3S3	A1O3S3	A1O4S3	A2O1S3	A2O1S3	A3O2S3	A3O2S3	A4O3S3	A4O3S3
19	AZO1S1	AZO4S1	A1O2S1	A1O4S1	A2O3S1	A2O4S1	A3O1S1	A3O1S1	A4O2S1	A4O2S1	AZO3S1	AZO3S1
20	AZO1S1	AZO4S2	A1O2S1	A1O4S2	A2O3S1	A2O4S2	A3O1S1	A3O1S2	A4O2S1	A4O2S2	AZO3S1	AZO3S2
21	AZO1S1	AZO4S3	A1O2S1	A1O4S3	A2O3S1	A2O4S3	A3O1S1	A3O1S3	A4O2S1	A4O2S3	AZO3S1	AZO3S3
22	AZO1S2	AZO4S1	A1O2S2	A1O4S1	A2O3S2	A2O4S1	A3O1S2	A3O1S1	A4O2S2	A4O2S1	AZO3S2	AZO3S1
23	AZO1S2	AZO4S2	A1O2S2	A1O4S2	A2O3S2	A2O4S2	A3O1S2	A3O1S2	A4O2S2	A4O2S2	AZO3S2	AZO3S2
24	AZO1S2	AZO4S3	A1O2S2	A1O4S3	A2O3S2	A2O4S3	A3O1S2	A3O1S3	A4O2S2	A4O2S3	AZO3S2	AZO3S3
25	AZO1S3	AZO4S1	A1O2S3	A1O4S1	A2O3S3	A2O4S1	A3O1S3	A3O1S1	A4O2S3	A4O2S1	AZO3S3	AZO3S1
26	AZO1S3	AZO4S2	A1O2S3	A1O4S2	A2O3S3	A2O4S2	A3O1S3	A3O1S2	A4O2S3	A4O2S2	AZO3S3	AZO3S2
27	AZO1S3	AZO4S3	A1O2S3	A1O4S3	A2O3S3	A2O4S3	A3O1S3	A3O1S3	A4O2S3	A4O2S3	AZO3S3	AZO3S3
28	A1O2S1	A1O3S1	A2O2S1	A2O4S1	A3O3S1	A3O4S1	A4O1S1	A4O1S1	AZO2S1	AZO2S1	A1O4S1	A1O4S1
29	A1O2S1	A1O3S2	A2O2S1	A2O4S2	A3O3S1	A3O4S2	A4O1S1	A4O1S2	AZO2S1	AZO2S2	A1O4S1	A1O4S2
30	A1O2S1	A1O3S3	A2O2S1	A2O4S3	A3O3S1	A3O4S3	A4O1S1	A4O1S3	AZO2S1	AZO2S3	A1O4S1	A1O4S3
31	A1O2S2	A1O3S1	A2O2S2	A2O4S1	A3O3S2	A3O4S1	A4O1S2	A4O1S1	AZO2S2	AZO2S1	A1O4S2	A1O4S1
32	A1O2S2	A1O3S2	A2O2S2	A2O4S2	A3O3S2	A3O4S2	A4O1S2	A4O1S2	AZO2S2	AZO2S2	A1O4S2	A1O4S2
33	A1O2S2	A1O3S3	A2O2S2	A2O4S3	A3O3S2	A3O4S3	A4O1S2	A4O1S3	AZO2S2	AZO2S3	A1O4S2	A1O4S3
34	A1O2S3	A1O3S1	A2O2S3	A2O4S1	A3O3S3	A3O4S1	A4O1S3	A4O1S1	AZO2S3	AZO2S1	A1O4S3	A1O4S1
35	A1O2S3	A1O3S2	A2O2S3	A2O4S2	A3O3S3	A3O4S2	A4O1S3	A4O1S2	AZO2S3	AZO2S2	A1O4S3	A1O4S2
36	A1O2S3	A1O3S3	A2O2S3	A2O4S3	A3O3S3	A3O4S3	A4O1S3	A4O1S3	AZO2S3	AZO2S3	A1O4S3	A1O4S3
37	A2O2S1	A2O3S1	A3O2S1	A3O4S1	A4O3S1	A4O4S1	AZO1S1	AZO1S1	A1O3S1	A1O3S1	A2O4S1	A2O4S1
38	A2O2S1	A2O3S2	A3O2S1	A3O4S2	A4O3S1	A4O4S2	AZO1S1	AZO1S2	A1O3S1	A1O3S2	A2O4S1	A2O4S2
39	A2O2S1	A2O3S3	A3O2S1	A3O4S3	A4O3S1	A4O4S3	AZO1S1	AZO1S3	A1O3S1	A1O3S3	A2O4S1	A2O4S3
40	A2O2S2	A2O3S1	A3O2S2	A3O4S1	A4O3S2	A4O4S1	AZO1S2	AZO1S1	A1O3S2	A1O3S1	A2O4S2	A2O4S1
41	A2O2S2	A2O3S2	A3O2S2	A3O4S2	A4O3S2	A4O4S2	AZO1S2	AZO1S2	A1O3S2	A1O3S2	A2O4S2	A2O4S2
42	A2O2S2	A2O3S3	A3O2S2	A3O4S3	A4O3S2	A4O4S3	AZO1S2	AZO1S3	A1O3S2	A1O3S3	A2O4S2	A2O4S3
43	A2O2S3	A2O3S1	A3O2S3	A3O4S1	A4O3S3	A4O4S1	AZO1S3	AZO1S1	A1O3S3	A1O3S1	A2O4S3	A2O4S1
44	A2O2S3	A2O3S2	A3O2S3	A3O4S2	A4O3S3	A4O4S2	AZO1S3	AZO1S2	A1O3S3	A1O3S2	A2O4S3	A2O4S2
45	A2O2S3	A2O3S3	A3O2S3	A3O4S3	A4O3S3	A4O4S3	AZO1S3	AZO1S3	A1O3S3	A1O3S3	A2O4S3	A2O4S3
46	A3O2S1	A3O3S1	A4O2S1	A4O4S1	AZO3S1	AZO4S1	A1O2S1	A1O2S1	A2O3S1	A2O3S1	A3O4S1	A3O4S1
47	A3O2S1	A3O3S2	A4O2S1	A4O4S2	AZO3S1	AZO4S2	A1O2S1	A1O2S2	A2O3S1	A2O3S2	A3O4S1	A3O4S2
48	A3O2S1	A3O3S3	A4O2S1	A4O4S3	AZO3S1	AZO4S3	A1O2S1	A1O2S3	A2O3S1	A2O3S3	A3O4S1	A3O4S3
49	A3O2S2	A3O3S1	A4O2S2	A4O4S1	AZO3S2	AZO4S1	A1O2S2	A1O2S1	A2O3S2	A2O3S1	A3O4S2	A3O4S1
50	A3O2S2	A3O3S2	A4O2S2	A4O4S2	AZO3S2	AZO4S2	A1O2S2	A1O2S2	A2O3S2	A2O3S2	A3O4S2	A3O4S2
51	A3O2S2	A3O3S3	A4O2S2	A4O4S3	AZO3S2	AZO4S3	A1O2S2	A1O2S3	A2O3S2	A2O3S3	A3O4S2	A3O4S3
52	A3O2S3	A3O3S1	A4O2S3	A4O4S1	AZO3S3	AZO4S1	A1O2S3	A1O2S1	A2O3S3	A2O3S1	A3O4S3	A3O4S1
53	A3O2S3	A3O3S2	A4O2S3	A4O4S2	AZO3S3	AZO4S2	A1O2S3	A1O2S2	A2O3S3	A2O3S2	A3O4S3	A3O4S2
54	A3O2S3	A3O3S3	A4O2S3	A4O4S3	AZO3S3	AZO4S3	A1O2S3	A1O2S3	A2O3S3	A2O3S3	A3O4S3	A3O4S3



[Kitting combination - 5000K, 5700K and 6500K]

-	RANK 1	RANK 2	RANK 1	RANK 2	RANK 1	RANK 2	RANK 1	RANK 2	RANK 1	RANK 2	RANK 1	RANK 2
1	A4O4S1	A4O4S1										
2	A4O4S1	A4O4S2										
3	A4O4S1	A4O4S3										
4	A4O4S2	A4O4S1										
5	A4O4S2	A4O4S2										
6	A4O4S2	A4O4S3										
7	A4O4S3	A4O4S1										
8	A4O4S3	A4O4S2										
9	A4O4S3	A4O4S3										
10	AZO4S1	AZO4S1										
11	AZO4S1	AZO4S2										
12	AZO4S1	AZO4S3										
13	AZO4S2	AZO4S1										
14	AZO4S2	AZO4S2										
15	AZO4S2	AZO4S3										
16	AZO4S3	AZO4S1										
17	AZO4S3	AZO4S2										
18	AZO4S3	AZO4S3										
19												
20												
21												
22												
23												
24												
25												
26												
27												
28												
29												
30												
31												
32												
33												
34												
35												
36												
37												
38												
39												
40												
41												
42												
43												
44												
45												
46												
47												
48												
49												
50												
51												
52												
53												
54												



3) Kitting bin Packing process

Reel

Kitting 'A'

A1T★S1
 SPMWHT221M▲5WA★0S0 A1★1S1 01
 GLAW94001 / 1001 / 4,000 pcs

Kitting 'B'

A1T★S2
 SPMWHT221M▲5WA★0S0 A1★1S1 01
 GLAW94001 / 1001 / 4,000 pcs

※ '★' means All kind of Chromaticity Coordinate Rank.

Aluminum Vinyl Bag

Kitting 'A'

A1T★S1
 SPMWHT221M▲5WA★0S0 A1★1S1 01
 GLAW94001 / 1001 / 4,000 pcs

Kitting 'B'

A1T★S2
 SPMWHT221M▲5WA★0S0 A1★1S1 01
 GLAW94001 / 1001 / 4,000 pcs

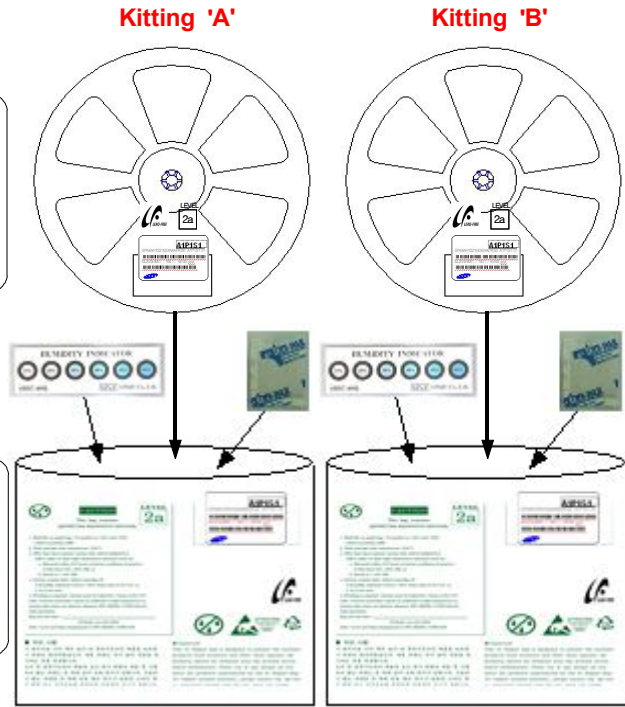

Inner Box

Kitting 'A'

A1T★S1
 SPMWHT221M▲5WA★0S0 A1★1S1 01
 GLAW94001 / 1001 / 4,000 pcs

Kitting 'B'

A1T★S2
 SPMWHT221M▲5WA★0S0 A1★1S1 01
 GLAW94001 / 1001 / 4,000 pcs

Material : Paper(SW3B(B))

TYPE	SIZE(mm)		
	a	b	c
7inch	215	285	44

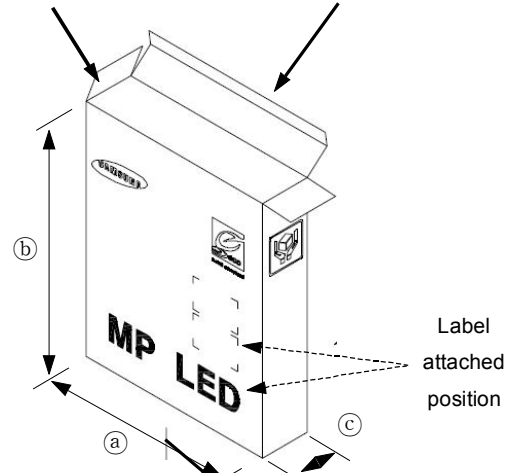

Outer Box

Kitting 'A'

A1T★S1
 SPMWHT221M▲5WA★0S0 A1★1S1 01
 GLAW94001 / 1001 / 4,000 pcs
 [BOX Label]

Kitting 'B'

A1T★S2
 SPMWHT221M▲5WA★0S0 A1★1S1 01
 GLAW94001 / 1001 / 4,000 pcs
 [BOX Label]

Material : Paper(SW3B(B))

TYPE	SIZE(mm)		
	a	b	c
7inch	250	302	227

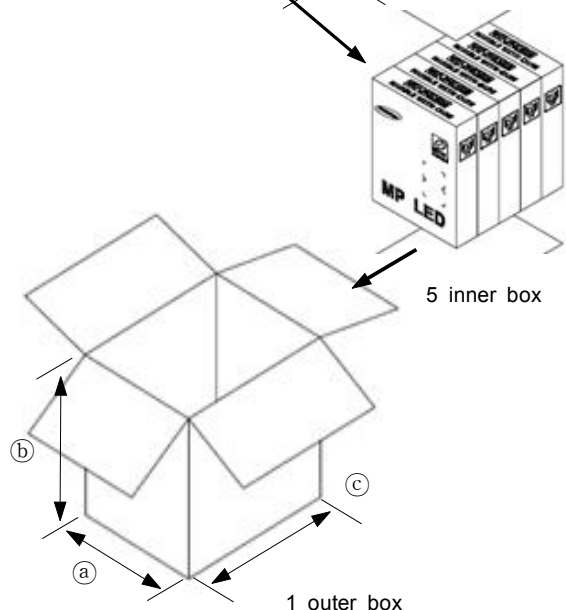

12. Precaution for use

- 1) For over-current-proof function, customers are recommended to apply resistors to prevent sudden change of the current caused by slight shift of the voltage.

과전류 방지를 위해 전압의 미세한 이동에 의해 야기되는 전류의 순간 변화를 방지하기 위해 저항 등의 설치를 권장함.

- 2) This device should not be used in any type of fluid such as water, oil, organic solvent, etc. When washing is required, IPA is recommended to use.

제품은 물, 오일, 유기물과 같은 액체 타입에서의 사용은 제한되며, 세정이 필요할 시에는 IPA 사용을 권장함.

- 3) When the LEDs illuminate, operating current should be decided after considering the ambient maximum temperature.

LED의 발광 시, 동작 전류는 주변 최고온도를 고려하여 결정되어야 함.

- 4) LEDs must be stored in a clean environment.

If the LEDs are to be stored for 3 months or more after being shipped from Samsung Electronics, they should be packed by a sealed container with nitrogen gas injected.(Shelf life of sealed bags: 12 months, temp. ~40°C, ~90%RH)

LED의 보관은 청정한 환경에서 보존되어야 하며, 만약 삼성전자로부터 공급받는 후 3개월 또는 그 이상 보관이 필요하다면 질소 가스를 동봉한 보존용기에 보관되어야 함. (보존 bag의 수명 : 12 개월, 보존 온도 ~40°C, 습도 ~90%RH)

- 5) After storage bag is open, device subjected to soldering, solder reflow, or other high temperature processes must be:

보존 Bag이 개봉된 후에, 납땀이나 reflow등의 높은 온도에 노출되는 제품은 다음의 사항에 부합되어야 함.

- a. Mounted within 672 hours(28 days) at an assembly line with a condition of no more than 30°C/60%RH,

a. 제품은 30°C/60%RH보다 같거나 낮은 조립조건에서 672시간(28일)이내에 조립해야 함.

- b. Stored at <10%RH.

b. 10% 이하의 상대습도에서 보관되어야 함.

- 6) Repack unused Products with anti-moisture packing, fold to close any opening and then store in a dry place.

사용하지 않은 제품은 방습팩에 넣어 개봉 부위를 닫아서 다시 포장한 후, 건조한 장소에서 보관할 것을 권장함.

7) Devices require baking before mounting, if humidity card reading is $>60\%$ at $23\pm 5^{\circ}\text{C}$.
만약 습도표시카드의 수치가 $23\pm 5^{\circ}\text{C}$ 에서 60% 이상이라면, 제품 실장 전 baking해야 함.

8) Devices must be baked for 1 hour at $65\pm 5^{\circ}\text{C}$, if baking is required.
만약 baking이 필요하다면, 제품은 $65\pm 5^{\circ}\text{C}$ 에서 1시간 정도 baking 되어야 함.

9) The LEDs are sensitive to the static electricity and surge. It is recommended to use a wrist band or anti-electrostatic glove when handling the LEDs.

LED는 정전기 및 서지에 민감한 제품이므로, LED 제품을 다룰 시에는 정전기 방지장갑이나 손목밴드를 사용하기를 권장함.

If voltage exceeding the absolute maximum rating is applied to LEDs, it may cause damage or even destruction to LED devices.

만약 절대 허용치를 초과하는 전압이 LED에 가해지면, LED 소자는 파괴되거나 손상될 수 있음.

Damaged LEDs may show some unusual characteristics such as increase in leak current, lowered turn-on voltage, or abnormal lighting of LEDs at low current.

손상된 제품은 누설전류의 증가, Turn on 전압의 저하, 저 전류에서의 점등불량 등의 이상 거동을 보일 수 있음.

10) VOCs (volatile organic compounds) can be generated from adhesives, flux, hardener or organic additives used in luminaires (fixtures). Transparent LED silicone encapsulant is permeable to those chemicals and they may lead a discoloration of encapsulant when they expose to heat or light.

VOCs(휘발성 유기 화합물)는 등기구에 사용되는 접착제, Flux, 경화제, 유기물 첨가제에서 발생하여 LED 실리콘 봉지체를 투과하고, 빛 또는 열에 노출되었을 때 변색이 발생 할 수 있음.

This phenomenon can cause a significant loss of light emitted(output) from the luminaires(fixture).

이러한 현상은 등기구로부터 나오는 빛의 중대한 손실을 줄 수 있음.

In order to prevent these problems, we recommend you to know the physical properties of materials used in luminaires, They must be selected carefully.

이러한 문제 발생 방지를 위해서, 등기구에 사용되는 자재에 대한 물성을 알고 주의하여 선택 되어야함.

11) Risk of Sulfurization (or Tarnishing)

The LED from Samsung Electronics uses a silver-plated lead frame and its surface color may change to black(or dark colored) when it is exposed to sulfur (S), chlorine (Cl) or other halogen compound

삼성전자의 LED는 Ag(은)을 도금한 리드프레임을 사용함. 이 리드프레임의 표면이 황(S), 염소(Cl), 또는 다른 할로겐 화합물들에 노출시 Ag(은)은 검정(또는 어두운색)으로 바뀔 수 있음.

Sulfurization of the lead frame may cause intensity degradation, change of chromaticity coordinates and, in extreme cases. open circuit. It requires caution.

리드 프레임의 황화(Sulfurization)는 광량 저하, 색좌표 변화 및 심한 경우 회로내의 LED 무등(Open) 불량을 일으킬 수도 있으니 주의가 필요함.

Due to possible sulfurization of lead frame, LED should not be used and stored together with oxidizing substances made of materials in a following list,

: Rubber, Plain paper, lead solder cream and so on.

리드 프레임 황화(Sulfurization)의 근원이 될 수 있으니 LED는 아래의 목록으로 만들어진 산화성 물질들과 함께 저장, 사용이 불가함 : 고무, 일반 종이, 납땜 크림 등

13. Hazard Substance Analysis - SGS



Test Report No. F690101/LF-CTSAYAA12-41400

Issued Date: 2012. 11. 26 Page 1 of 6

To: SAMSUNG ELECTRONICS CO., LTD.
 24 Nongseo-dong
 Giheung-gu
 Yongin-si
 Gyeonggi-do
 Korea

The following merchandise was submitted and identified by the client as :

SGS File No. : AYAA12-41400
Product Name : LED Package
Item No./Part No. : N/A
Client Reference Data : 2323 WHITE PKG
Received Date : 2012. 11. 19
Test Period : 2012. 11. 20 to 2012. 11. 26
Test Results : For further details, please refer to following page(s)
Test Performed : SGS Korea tested the sample(s) selected by applicant with following results.
Test Comments : By the applicant's specific request, the sampling and testing was performed only for the part indicated in the photo without disassembly.
Report Comments : By the applicant's request, item No.s/part No.s & client reference information are stated/added on report.

Timothy Jeon
 Jinhee Kim
 Cindy Park
 Jerry Jung/ Testing Person

SGS Korea Co., Ltd.

 Jeff Jang / Chemical Lab Mgr

This document is issued by the Company subject to its General Conditions of Service printed on each test available on request or accessible at <http://www.sgs.com/ServiceandConditions.aspx> and for electronic format documents, subject to Terms and Conditions for Electronic Documents at <http://www.sgs.com/ServiceandConditions.aspx>. Attention is drawn to the limitation of liability, identification and production issues defined therein. Any holder of this document is advised that information under its control reflects the Company's findings at the time of its intervention only and within the limits of Clients' instructions, if any. The Company's sole responsibility is to its Client and this document does not exonerate parties to a transaction from exercising all their rights and obligations under the transaction documents. This document cannot be reproduced except in full, without prior written approval of the Company. Any unauthorized alteration, forgery or falsification of the content or appearance of this document is unlawful and offenders may be prosecuted to the fullest extent of the law. Unless otherwise stated the results shown in this test report refer only to the sample(s) tested and such sample(s) are retained for 90 days only.

Test Report No. F690101/LF-CTSAYAA12-41400

Issued Date: 2012. 11. 26 Page 2 of 6

Sample No. : AYAA12-41400.001
Sample Description : LED Package
Item No./Part No. : N/A
Materials : N/A

Heavy Metals

Test Items	Unit	Test Method	MDL	Results
Cadmium (Cd)	mg/kg	With reference to IEC 62321:2008, ICP	0.5	N.D.
Lead (Pb)	mg/kg	With reference to IEC 62321:2008, ICP	5	N.D.
Mercury (Hg)	mg/kg	With reference to IEC 62321:2008, ICP	2	N.D.
Hexavalent Chromium (Cr VI)	mg/kg	With reference to IEC 62321:2008, UV-VIS	1	N.D.

Flame Retardants-PBBs/PBDEs

Test Items	Unit	Test Method	MDL	Results
Monobromobiphenyl	mg/kg	With reference to IEC 62321:2008, GC-MS	5	N.D.
Dibromobiphenyl	mg/kg	With reference to IEC 62321:2008, GC-MS	5	N.D.
Tribromobiphenyl	mg/kg	With reference to IEC 62321:2008, GC-MS	5	N.D.
Tetrabromobiphenyl	mg/kg	With reference to IEC 62321:2008, GC-MS	5	N.D.
Pentabromobiphenyl	mg/kg	With reference to IEC 62321:2008, GC-MS	5	N.D.
Hexabromobiphenyl	mg/kg	With reference to IEC 62321:2008, GC-MS	5	N.D.
Heptabromobiphenyl	mg/kg	With reference to IEC 62321:2008, GC-MS	5	N.D.
Octabromobiphenyl	mg/kg	With reference to IEC 62321:2008, GC-MS	5	N.D.
Nonabromobiphenyl	mg/kg	With reference to IEC 62321:2008, GC-MS	5	N.D.
Decabromobiphenyl	mg/kg	With reference to IEC 62321:2008, GC-MS	5	N.D.
Monobromodiphenyl ether	mg/kg	With reference to IEC 62321:2008, GC-MS	5	N.D.
Dibromodiphenyl ether	mg/kg	With reference to IEC 62321:2008, GC-MS	5	N.D.
Tribromodiphenyl ether	mg/kg	With reference to IEC 62321:2008, GC-MS	5	N.D.
Tetrabromodiphenyl ether	mg/kg	With reference to IEC 62321:2008, GC-MS	5	N.D.
Pentabromodiphenyl ether	mg/kg	With reference to IEC 62321:2008, GC-MS	5	N.D.
Hexabromodiphenyl ether	mg/kg	With reference to IEC 62321:2008, GC-MS	5	N.D.
Heptabromodiphenyl ether	mg/kg	With reference to IEC 62321:2008, GC-MS	5	N.D.
Octabromodiphenyl ether	mg/kg	With reference to IEC 62321:2008, GC-MS	5	N.D.
Nonabromodiphenyl ether	mg/kg	With reference to IEC 62321:2008, GC-MS	5	N.D.
Decabromodiphenyl ether	mg/kg	With reference to IEC 62321:2008, GC-MS	5	N.D.

Halogen Content
NOTE:

- (1) N.D. = Not detected. (<MDL)
- (2) mg/kg = ppm
- (3) MDL = Method Detection Limit
- (4) - = No regulation
- (5) Negative = Undetectable / Positive = Detectable
- (6) ** = Qualitative analysis (No Unit)
- (7) * = Boiling-water-extraction:
 Negative = Absence of CrVI coating
 Positive = Presence of CrVI coating; the detected concentration in boiling-water-extraction solution is equal or greater than 0.02 mg/kg with 50 cm² sample surface area.

This document is issued by the Company subject to its General Conditions of Service printed overleaf available on request or accessible at www.sgs.com/termsandconditions and, for electronic format documents, subject to Terms and Conditions for Electronic Documents at www.sgs.com/termsandconditions. Attention is drawn to the limitation of liability, indemnification and jurisdiction issues defined therein. Any holder of this document is advised that information contained herein reflects the Company's findings at the time of its intervention only and within the limits of Client's instructions, if any. The Company's sole responsibility is to its Client(s); the document does not exonerate parties to a transaction from exercising all their rights and obligations under the transaction documents. This document cannot be reproduced except in full, without prior written approval of the Company. Any unauthorised alteration, forgery or falsification of the content or appearance of this document is unlawful and offenders may be prosecuted to the fullest extent of the law.

Unless otherwise stated, the results shown in this test report refer only to the samples tested and such samples are retained for 90 days only.

SGS Korea Co., Ltd.

 322, The O valley, 555-0, Hoge-dong, Dongan-gu, Anyang-si, Gyeonggi-do, Korea 431-080
 T +82 (0)31 4808 000 F +82 (0)31 4808 050 <http://www.sgs.com> www.kr.sgs.com sgs@sgs.com

F052 Version5

Member of the SGS Group (Société Générale de Surveillance)

Test Report No. F690101/LF-CTSAYAA12-41400

Issued Date: 2012. 11. 26 Page 3 of 6

Sample No. : AYAA12-41400.001
Sample Description : LED Package
Item No./Part No. : N/A
Materials : N/A

Halogen Content

Test Items	Unit	Test Method	MDL	Results
Bromine(Br)	mg/kg	BS EN 14582:2007 , IC	30	N.D.
Chlorine(Cl)	mg/kg	BS EN 14582:2007 , IC	30	N.D.
Fluorine(F)	mg/kg	BS EN 14582:2007 , IC	30	N.D.
Iodine(I)	mg/kg	BS EN 14582:2007 , IC	50	N.D.

Other(s)

Test Items	Unit	Test Method	MDL	Results
PFOS (Perfluorooctane Sulfonates-Acid/Metal Salt/Amide)	mg/kg	US EPA 3540C/3550C, LC/MS	1	N.D.

NOTE:

- (1) N.D. = Not detected.(<MDL)
- (2) mg/kg = ppm
- (3) MDL = Method Detection Limit
- (4) - = No regulation
- (5) Negative = Undetectable / Positive = Detectable
- (6) ** = Qualitative analysis (No Unit)
- (7) * = Boiling-water-extraction:
 Negative = Absence of CrVI coating
 Positive = Presence of CrVI coating; the detected concentration in boiling-water-extraction solution is equal or greater than 0.02 mg/kg with 50 cm2 sample surface area.

This document is issued by the Company subject to its General Conditions of Service printed hereon, available on request or accessible at www.sgs.com for electronic format documents, subject to Terms and Conditions for Electronic Documents at www.sgs.com/eng/electronic_documents.htm. Attention is drawn to the limitation of liability, indemnification and jurisdiction clauses defined therein. Any holder of this document is advised that information contained herein shall be the Company's property at the time of its issuance and may be subject to the terms of the license agreement, if any. The Company's sole responsibility is to its Client and the document does not exonerate parties to a transaction from exercising their rights and obligations under the transaction documents. This document cannot be reproduced except in full, without prior written approval of the Company. Any unauthorized alteration, forgery or falsification of the content or appearance of this document is unlawful and offenders may be prosecuted to the fullest extent of the law. Unless otherwise stated, the results shown in this test report refer only to the samples tested and such samples are retained for 90 days only.

F052 Version5

SGS Korea Co.,Ltd.

 322, The O valley, 555-0, Hoge-dong, Dongan-gu, Anyang-si, Gyeonggi-do, Korea 431-080
 T +82 (0)31 4808 000 F +82 (0)31 4808 050 <http://www.snlab.co.kr> www.kr.sgs.com/ksnslab

Member of the SGS Group (Société Générale de Surveillance)

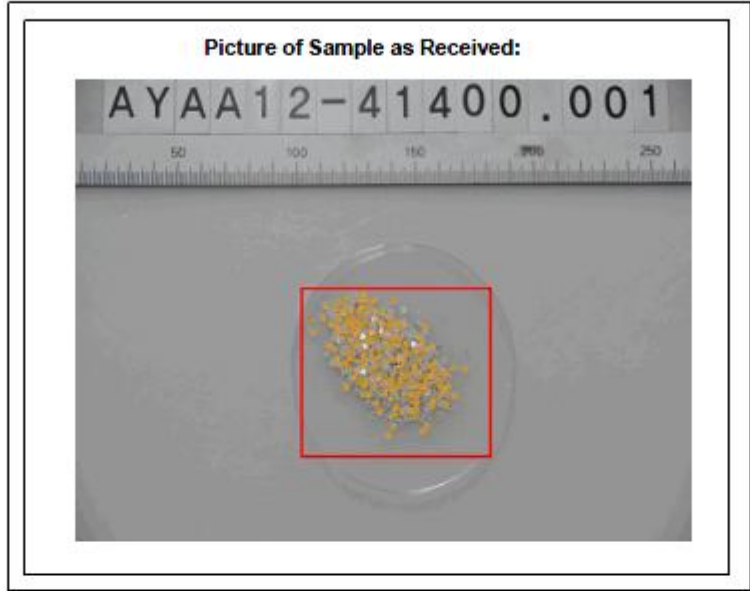

NOTE:

- (1) N.D. = Not detected.(<MDL)
- (2) mg/kg = ppm
- (3) MDL = Method Detection Limit
- (4) - = No regulation
- (5) Negative = Undetectable / Positive = Detectable
- (6) ** = Qualitative analysis (No Unit)
- (7) * = Boiling-water-extraction:
 Negative = Absence of CrVI coating
 Positive = Presence of CrVI coating; the detected concentration in boiling-water-extraction solution is equal or greater than 0.02 mg/kg with 50 cm2 sample surface area.

The document is issued by the Company subject to its General Conditions of Service printed overleaf available on request or accessible at <http://www.sgs.com/ServiceandConditions> and, for electronic format documents, subject to Terms and Conditions for electronic Documents at <http://www.sgs.com/ServiceandConditions>. Attention is drawn to the limitation of liability, indemnification and jurisdiction issues defined therein. Any holder of this document is advised that information contained herein reflects the Company's findings at the time of its intervention only and within the limits of Client's instructions, if any. The Company's sole responsibility is to its Client and the document does not exonerate parties to a transaction from exercising all their rights and obligations under the transaction documents. This document cannot be reproduced except in full, without prior written approval of the Company. Any unauthorized alteration, forgery or falsification of the content or appearance of this document is unlawful and offenders may be prosecuted to the fullest extent of the law. Unless otherwise stated, the results shown in this test report refer only to the sample(s) tested and such sample(s) are retained for 90 days only.



Test Report No. F690101/LF-CTSAYAA12-41400

Issued Date: 2012. 11. 26 Page 5 of 6

Testing Flow Chart for RoHS: Cd/Pb/Hg/Cr⁶⁺ /PBBs&PBDEs Testing

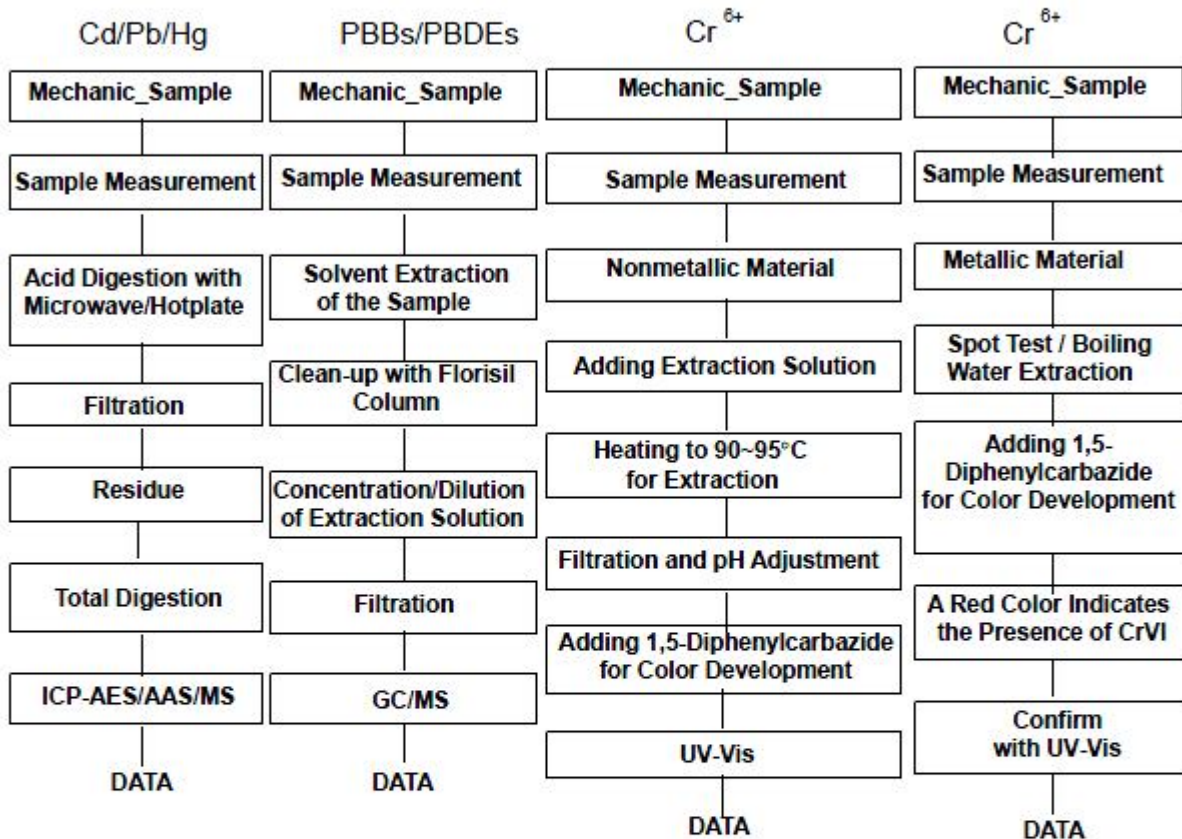

The samples were dissolved totally by pre-conditioning method according to above flow chart for Cd,Pb,Hg.
Section Chief : Gilsae Yi

NOTE:

- (1) N.D. = Not detected.(<MDL)
- (2) mg/kg = ppm
- (3) MDL = Method Detection Limit
- (4) - = No regulation
- (5) Negative = Undetectable / Positive = Detectable
- (6) ** = Qualitative analysis (No Unit)
- (7) * = Boiling-water-extraction:
 Negative = Absence of CrVI coating
 Positive = Presence of CrVI coating; the detected concentration in boiling-water-extraction solution is equal or greater than 0.02 mg/kg with 50 cm² sample surface area.

This document is issued by the Company subject to its General Conditions of Service printed overleaf available on request or accessible at <http://www.samsungled.com/termsandconditions.pdf> and, for electronic format documents, subject to Terms and Conditions for electronic Documents at <http://www.samsungled.com/termsandconditions.pdf>. Attention is drawn to the limitation of liability, indemnification and jurisdiction issues defined therein. Any holder of this document is advised that information contained herein - which is the Company's property at the time of its issuance - may be used within the limits of the law, including, if any, the Company's own responsibility & to its clients and the document does not constitute a transaction from existing at their rights and obligations under the transaction documents. This document cannot be reproduced except in full, without prior written approval of the Company. Any unauthorised alteration, forgery or falsification of the content or appearance of this document is unlawful and offenders may be prosecuted to the fullest extent of the law. Unless otherwise stated, the results shown in this test report refer only to the samples tested and such samples are retained for 90 days only.



Flow Chart for Halogen Test

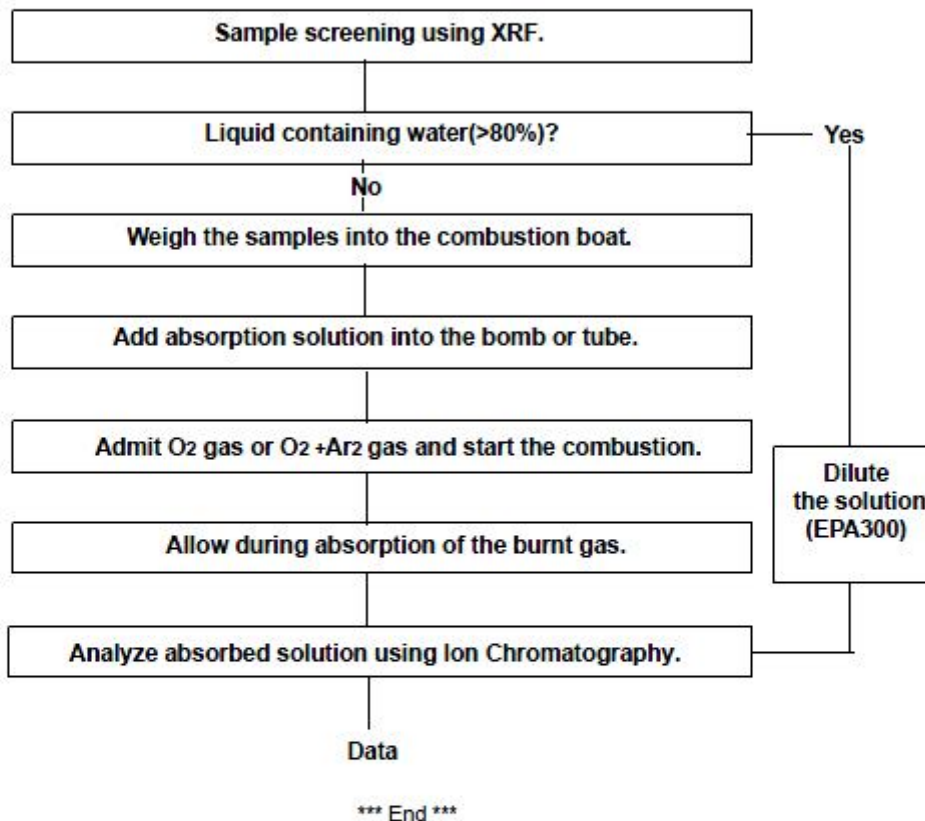

NOTE:

- (1) N.D. = Not detected.(<MDL)
- (2) mg/kg = ppm
- (3) MDL = Method Detection Limit
- (4) - = No regulation
- (5) Negative = Undetectable / Positive = Detectable
- (6) ** = Qualitative analysis (No Unit)
- (7) * = Boiling-water-extraction:
 Negative = Absence of CrVI coating
 Positive = Presence of CrVI coating; the detected concentration in boiling-water-extraction solution is equal or greater than 0.02 mg/kg with 50 cm2 sample surface area.

This document is issued by the Company subject to its General Conditions of Service printed overleaf, available on request or accessible at http://www.samsunglab.com/Conditions_of_Service.pdf and for electronic format documents, subject to Terms and Conditions for Electronic Documents at <http://www.samsunglab.com/conditio>. Attention is drawn to the limitation of liability, indemnification and jurisdiction issues defined therein. Any holder of this document is advised that information contained herein reflects the Company's findings at the time of its issuance only and within the limits of Client's instructions, if any. The Company's sole responsibility is to its Client; the document does not constitute a warranty or an endorsement of any goods or services of any third party. The document is issued under the trademark of the Company. This document cannot be reproduced except in full, without prior written approval of the Company. Any unauthorized alteration, forgery or falsification of the content or appearance of this document is unlawful and offenders may be prosecuted to the fullest extent of the law. Unless otherwise stated, the results shown in this test report refer only to the samples tested and such samples are retained for 90 days only.

13. Hazard Substance Analysis - SVHC(REACH)



Test Report No. F690101/LF-CTSAYAA12-41399 Issued Date: November 26, 2012 Page 1 of 14

To: **SAMSUNG ELECTRONICS CO., LTD.**
San 24, Nongseo-dong
Giheung-gu
Yongin-si
Gyeonggido
Korea

The following sample(s) was/were submitted and identified by/on behalf of the client as:-

Product Name	: LED Package
Item/Part Name	: N/A
Client reference data	: 2323 WHITE PKG
SGS File No.	: AYAA12-41399
Received Date	: November 16, 2012
Test Period	: November 19, 2012 ~ November 26, 2012
Test Performed	: SGS Korea tested the sample(s) selected by applicant with following results
Test Requested	: Eighty-four (84) substances in the Candidate List of Substances of Very High Concern (SVHC) for authorization published by European Chemicals Agency (ECHA) on and before June 18, 2012 regarding Regulation (EC) No 1907/2006 concerning the REACH. Fifty-four (54) substances in the Public Consultation List of potential Substances of Very High Concern (SVHC) published by European Chemicals Agency (ECHA) on September 03, 2012 regarding Regulation (EC) No 1907/2006 concerning the REACH.
Test Method	: Please refer to next page(s).
Test Result(s)	: Please refer to next page(s).
Summary	: According to the specified scope and analytical technique, concentrations of all SVHC are <0.1% in the submitted sample(s).
Comment(s)	: By the applicant's request, item No.s/part No.s & client reference information are stated/added on report.

Timothy Jeon
Cindy park
Jinhee Kim
Sophia Kim
/Testing Person

SGS Korea Co., Ltd

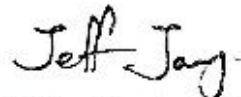

Jeff Jang / Chemical Lab Mgr

This document is issued by the Company subject to its General Conditions of Service printed overleaf, available on request or accessible at <http://www.sgs.com/sgs/termsandconditions> and, for electronic format documents, subject to Terms and Conditions for Electronic Documents at <http://www.sgs.com/sgs/termsandconditions>. Attention is drawn to the limitation of liability, indemnification and jurisdiction issues defined therein. Any holder of this document is advised that all information contained herein reflects the Company's findings at the time of its observation only and without the benefit of a microscope, if any. The Company's sole responsibility is to its Client and this document does not accrue liability to a transaction from or entitle all their rights and obligations under the transaction documents. This document cannot be reproduced except in full, without prior written approval of the Company. Any unauthorized alteration, forgery or falsification of the content or appearance of this document is unlawful and offenders may be prosecuted to the fullest extent of the law. Unless otherwise stated the results shown in the test report refer only to the sample(s) tested and each sample(s) was retained for 30 days only.

F052 Version 5

SGS Korea Co., Ltd.

322, The Ovalley, 555-9, Hogeong-dong, Dongan-gu, Anyang-si, Gyeonggi-do, Korea 431-080
t +82 (0)31 4608 000 f +82 (0)31 4608 050 <http://www.sgslab.co.kr> www.kr.sgs.com/sgslab

Member of the SGS Group (Société Générale de Surveillance)



Test Report No. F690101/LF-CTSAYAA12-41399 Issued Date: November 26, 2012 Page 2 of 14

Test Method:

SGS In-House method - Analyzed by ICP-OES, PLM, UV/VIS, LC/MS ,GC/MS and colorimetric method

Remarks:

1. The chemical analysis of specified SVHC is performed by means of currently available analytical techniques against the following SVHC related documents published by ECHA:
<http://echa.europa.eu/web/guest/candidate-list-table> (Candidate list)
http://echa.europa.eu/en/web/guest/view-article/-/journal_content/512b7526-9dd6-4872-934e-8c298c89ad99 (Potential list)
 These lists are under evaluation by ECHA and may subject to change in the future.
2. In accordance with Regulation (EC) No 1907/2006, any producer or importer of articles shall notify ECHA, in accordance with paragraph 2 of Article 7, if a substance meets the criteria in Article 57 and is identified in accordance with Article 59(1) of the Regulation, if (a) the substance is present in those articles in quantities totaling over one tonne per producer or importer per year; and (b) the substance is present in those articles above a concentration of **0.1%** weight by weight (w/w).
3. Article 33 of Regulation (EC) No 1907/2006 requires supplier of an article containing a substance meeting the criteria in Article 57 and identified in accordance with Article 59(1) in a concentration above **0.1%** weight by weight (w/w) shall provide the recipient of the article with sufficient information, available to the supplier, to allow safe use of the article including, as a minimum, the name of that substance in the Candidate List.
4. SGS adopts the interpretation of ECHA for SVHC in article unless indicated otherwise. Detail explanation is available at the following link:
http://webstage.contribute.sgs.net/corpreach/documents/SGS-CTS_SVHC-paper-EN-11.pdf
5. Test results in this report are based on the tested sample. This report refers to testing result of composite material group by equal weight proportion. The material in each composite test group may come from one article.
6. If a SVHC is found over the reporting limit, client is suggested to identify the component which contains the SVHC and the exact concentration of the SVHC by requesting further quantitative analysis from the laboratory.

The document is issued by the Company subject to its General Conditions of Service printed overleaf, available on request or accessible at <http://www.sgs.com/en/Terms-and-Conditions.sgs> and, for electronic format documents, subject to Terms and Conditions for Electronic Documents at www.sgs.com/extra_electronic_docs. Attention is drawn to the limitation of liability, indemnification and jurisdiction issues outlined therein. Any holder of this document is advised that all or part of the information contained herein reflects the Company's findings at the time of its dissemination only and within the limits of IAB's instructions. It is the Company's sole responsibility as to its Client and this document does not constitute parties to a transaction from ascertaining all their rights and obligations under the transaction documents. This document cannot be reproduced (except in full) without prior written approval of the Company. Any unauthorised alteration, forgery or falsification of the content or appearance of this document is unlawful and offensive and may be prosecuted to the fullest extent of the law. Clients shall ensure that the results shown in this test report refer only to the sample(s) tested and such sample(s) are retained for 90 days only.

F052 Version 5

SGS Korea Co., Ltd.

322, The Ovalley, 555-9, Hoggae-dong, Dongan-gu, Anyang-si, Gyeonggi-do, Korea 431-080
 t +82 (0)31 4608 000 f +82 (0)31 4608 059 <http://www.sgslab.co.kr> www.kr.sgs.com/greenlab

Member of the SGS Group (Société Générale de Surveillance)

Test Report No. F690101/LF-CTSAYAA12-41399

Issued Date: November 26, 2012

Page 3 of 14

Test Result(s)

Substance Name	CAS number	EC number	Concentration (%)	Reporting Limit (%)	Classification
Alkanes, C10-13, chloro (Short Chain Chlorinated Paraffins)	85535-84-8	287-476-5	N.D.	0.05	PBT
Anthracene	120-12-7	204-371-1	N.D.	0.05	PBT
Benzyl butyl phthalate (BBP)	85-68-7	201-622-7	N.D.	0.05	Toxic for Reproduction
Bis(2-ethylhexyl)phthalate (DEHP)	117-81-7	204-211-0	N.D.	0.05	Toxic for Reproduction
Bis(tributyltin)oxide	56-35-9	200-268-0	N.D.	0.05	PBT
Cobalt dichloride*	7646-79-9	231-589-4	N.D.	0.005	Carcinogen Toxic for Reproduction
4,4-Diaminodiphenylmethane	101-77-9	202-974-4	N.D.	0.05	Carcinogen
Diarsenic pentaoxide*	1303-28-2	215-116-9	N.D.	0.005	Carcinogen
Diarsenic trioxide*	1327-53-3	215-481-4	N.D.	0.005	Carcinogen
Dibutyl phthalate (DBP)	84-74-2	201-557-4	N.D.	0.05	Toxic for Reproduction
Hexabromocyclododecane (HBCDD) and all major diastereoisomers identified (α -HBCDD, β -HBCDD, γ -HBCDD)	25637-99-4 and 3194-55-6 (134237-51-7, 134237-50-6, 134237-52-8)	247-148-4 and 221-695-9	N.D.	0.05	PBT
Lead hydrogen arsenate*	7784-40-9	232-064-2	N.D.	0.005	Carcinogen Toxic for Reproduction
Sodium dichromate (Sodium dichromate, dehydrate)	10588-01-9 (7789-12-0)	234-190-3	N.D.	0.005	Carcinogen Mutagen Toxic for Reproduction
5-tert-butyl-2,4,6-trinitro-m-xylene (musk xylene)	81-15-2	201-329-4	N.D.	0.05	vPvB
Triethyl arsenate*	15606-95-8	427-700-2	N.D.	0.005	Carcinogen

This document is issued by the Company subject to its General Conditions of Service printed overleaf, available on request or accessible at <http://www.sgs.com/sgs/TermsandConditions.aspx> and, for electronic formal documents, subject to Terms and Conditions for Electronic Documents at www.sgs.com/sgs/electronic.aspx. Attention is drawn to the limitation of liability, indemnification and jurisdiction issues outlined therein. Any notice of this document is deemed that all printed contained herein reflects the Company's findings at the time of its dissemination only and within the limits of its analytical instructions. It is the Company's sole responsibility as to its Client and this document does not assume liability to a transaction from ascribing all their rights and obligations under the transaction documents. This document cannot be reproduced (except in full, without prior written approval of the Company. Any unauthorized alteration, forgery or falsification of the content or appearance of this document is unlawful and offenders may be prosecuted to the fullest extent of the law. Unless otherwise stated the results shown in this test report refer only to the sample(s) tested and each sample(s) was tested for 30 days only.

F052 Version 5

SGS Korea Co., Ltd.

 322, The Ovalley, 555-9, Hoge-dong, Dongan-gu, Anyang-si, Gyeonggi-do, Korea 431-080
 t +82 (0)31 4608 000 f +82 (0)31 4608 059 <http://www.sgslab.co.kr> www.kr.sgs.com/greenlab

Member of the SGS Group (Società Generale da Sorveglianza)



Test Report No. F690101/LF-CTSAYAA12-41399 Issued Date: November 26, 2012 Page 4 of 14

Substance Name	CAS number	EC number	Concentration (%)	Reporting Limit (%)	Classification
Di-isobutyl phthalate(DIBP)	84-69-5	201-553-2	N.D.	0.05	Toxic for Reproduction
2,4-Dinitrotoluene	121-14-2	204-450-0	N.D.	0.05	Carcinogen
Tris(2-chloroethyl) phosphate	115-96-8	204-118-5	N.D.	0.05	Toxic for Reproduction
Anthracene oil	90640-80-5	292-602-7	N.D.	0.05	PBT; vPvB Carcinogen
Anthracene oil, anthracene paste; distn. Lights	91995-17-4	295-278-5	N.D.	0.05	PBT; vPvB Carcinogen Mutagen
Anthracene oil, anthracene paste, anthracene fraction	91995-15-2	295-275-9	N.D.	0.05	PBT; vPvB Carcinogen Mutagen
Anthracene oil, anthracene-low	90640-82-7	292-604-8	N.D.	0.05	PBT; vPvB Carcinogen Mutagen
Anthracene oil, anthracene paste	90640-81-6	292-603-2	N.D.	0.05	PBT; vPvB Carcinogen Mutagen
Coal tar pitch, high temperature	65996-93-2	266-028-2	N.D.	0.05	PBT; vPvB Carcinogen
Lead sulfochromate yellow (C.I. Pigment Yellow 34)*	1344-37-2	215-693-7	N.D.	0.005	Carcinogen Toxic for Reproduction
Lead chromate molybdate sulfate red (C.I. Pigment Red 104)*	12656-85-8	235-759-9	N.D.	0.005	Carcinogen Toxic for Reproduction
Lead chromate*	7758-97-6	231-846-0	N.D.	0.005	Carcinogen Toxic for Reproduction
Acrylamide	79-06-01	201-173-7	N.D.	0.05	Carcinogen Mutagen

This document is issued by the Company subject to its General Conditions of Service printed therein, available on request or accessible at http://www.sgs.com/sgs/Terms_and_Conditions_sgs.pdf, and for electronic formal documents, subject to Terms and Conditions for Electronic Documents at www.sgs.com/sgs/e-document.htm. Attention is drawn to the limitation of liability, indemnification and jurisdiction issues defined therein. Any holder of this document is advised that the printed contained herein reflects the Company's findings at the time of its issuance only and within the limits of the instructions it sets. The Company's sole responsibility is to its Client and this document does not assume liability to a transaction from which all their rights and obligations under the transaction documents. This document cannot be reproduced (except in full, without prior written approval of the Company) Any unauthorized alteration, forgery or falsification of the content or appearance of this document is unlawful and offenders may be prosecuted to the fullest extent of the law. Unless otherwise stated the results shown in this test report refer only to the sample(s) tested and such sample(s) was/were tested for 30 days only.

F052 Version 5

SGS Korea Co., Ltd.

322, The Ovalley, 555-9, Hoge-dong, Dongan-gu, Anyang-si, Gyeonggi-do, Korea 431-080
 t +82 (0)31 4608 000 f +82 (0)31 4608 059 <http://www.sgslab.co.kr> www.kr.sgs.com/greenlab

Member of the SGS Group (Società Generale di Sorveglianza)



Test Report No. F690101/LF-CTSAYAA12-41399 Issued Date: November 26, 2012 Page 5 of 14

Substance Name	CAS number	EC number	Concentration (%)	Reporting Limit (%)	Classification
Boric acid*	10043-35-3 11113-50-1	233-139-2 234-343-4	N.D.	0.005	Toxic for Reproduction
Disodium tetraborate, anhydrous*	1330-43-4 12179-04-3 1303-96-4	215-540-4	N.D.	0.005	Toxic for Reproduction
Tetraboron disodium heptaoxide, hydrate*	12267-73-1	235-541-3	N.D.	0.005	Toxic for Reproduction
Trichloroethylene	79-01-6	201-167-4	N.D.	0.05	Carcinogen
Sodium chromate*	7775-11-3	231-889-5	N.D.	0.005	Carcinogen Mutagen Toxic for Reproduction
Ammonium dichromate*	7789-09-5	232-143-1	N.D.	0.005	Carcinogen Mutagen Toxic for Reproduction
Potassium dichromate*	7778-50-9	231-906-6	N.D.	0.005	Carcinogen Mutagen Toxic for Reproduction
Potassium chromate*	7789-00-6	232-140-5	N.D.	0.005	Carcinogen Mutagen

The document is issued by the Company subject to its General Conditions of Service printed overleaf, available on request or accessible at <http://www.sgs.com/en/Forms-and-Conditions> and, for electronic format documents, subject to Terms and Conditions for Electronic Documents at www.sgs.com/Forms-and-Conditions. Attention is drawn to the limitation of liability, indemnification and jurisdiction issues defined therein. Any holder of this document is advised that the information contained herein reflects the Company's findings at the time of its intervention only and within the limits of its analytical methods. The Company's sole responsibility is to its Client and this document does not constitute advice to a transaction nor does it release the Client from its obligations under the transaction documents. This document cannot be reproduced (except in full) without prior written approval of the Company. Any unauthorized alteration, forgery or falsification of the content or appearance of this document is unlawful and offenders may be prosecuted to the fullest extent of the law. Unless otherwise stated the results shown in this test report refer only to the sample(s) tested and such sample(s) are released for 90 days only.

F052 Version 5

SGS Korea Co., Ltd.

322, The Ovalley, 555-9, Hogeys-dong, Dongan-gu, Anyang-si, Gyeonggi-do, Korea 431-080
t +82 (0)31 4608 000 f +82 (0)31 4608 050 <http://www.sgslab.co.kr> www.kr.sgs.com/greenlab

Member of the SGS Group (Société Générale de Surveillance)

Substance Name	CAS number	EC number	Concentration (%)	Reporting Limit (%)	Classification
Cobalt(II) sulphate*	10124-43-3	233-334-2	N.D.	0.005	Carcinogen Toxic for Reproduction
Cobalt(II) dinitrate*	10141-05-6	233-402-1	N.D.	0.005	Carcinogen Toxic for Reproduction
Cobalt(II) carbonate*	513-79-1	208-169-4	N.D.	0.005	Carcinogen Toxic for Reproduction
Cobalt(II) diacetate*	71-48-7	200-755-8	N.D.	0.005	Carcinogen Toxic for Reproduction
2-Methoxyethanol	109-86-4	203-713-7	N.D.	0.05	Toxic for Reproduction
2-Ethoxyethanol	110-80-5	203-804-1	N.D.	0.05	Toxic for Reproduction
Chromium trioxide*	1333-82-0	215-607-8	N.D.	0.005	Carcinogen Mutagen
Acids generated from chromium trioxide and their oligomers: Chromic acid Dichromic acid Oligomers of chromic acid and dichromic acid	7738-94-5 13530-68-2	231-801-5 236-881-5	N.D.	0.005	Carcinogen
1-methyl-2-pyrrolidone	872-50-4	212-828-1	N.D.	0.05	Toxic for Reproduction
2-ethoxyethyl acetate	111-15-9	203-839-2	N.D.	0.05	Toxic for Reproduction
1,2-benzenedicarboxylic acid, di-C6-8-branched alkyl esters, C7-rich	71888-89-6	276-158-1	N.D.	0.05	Toxic for Reproduction
1,2-benzenedicarboxylic acid, di-C7-11-branched and linear alkyl esters	68515-42-4	271-084-6	N.D.	0.05	Toxic for Reproduction
1,2,3-trichloropropane	96-18-4	202-486-1	N.D.	0.05	Carcinogen Toxic for Reproduction
Hydrazine	7803-57-8 302-01-2	206-114-9	N.D.	0.05	Carcinogen
Strontium chromate*	7789-06-2	232-142-6	N.D.	0.005	Carcinogen

This document is issued by the Company subject to its General Conditions of Service printed overleaf, available on request or accessible at <http://www.sgs.com/en/Terms-and-Conditions.aspx> and, for electronic format documents, subject to Terms and Conditions for Electronic Documents at <http://www.sgs.com/etms/eDocuments.htm>. Attention is drawn to the limitation of liability, indemnification and jurisdiction issues defined therein. Any notice of this document is deemed to have been provided to the Client at the time of its dissemination only and within the limits of the Client's instructions. It is the Client's sole responsibility as to its Client and this document does not assume liability to a transaction from as a client all their rights and obligations under the transaction documents. This document cannot be reproduced except in full, without prior written approval of the Company. Any unauthorized alteration, forgery or falsification of the content or appearance of this document is unlawful and offenders may be prosecuted to the fullest extent of the law. Unless otherwise stated the results shown in this test report refer only to the sample(s) tested and such sample(s) are referred to as 'Sample(s)' only.

F052 Version 5

SGS Korea Co., Ltd.

 322, The Ovalley, 555-9, Hoge-dong, Dongan-gu, Anyang-si, Gyeonggi-do, Korea 431-080
 t +82 (0)31 4608 000 f +82 (0)31 4608 059 <http://www.sgslab.co.kr> www.kr.sgs.com/sgslab

Member of the SGS Group (Società Generale de Surveillance)

Substance Name	CAS number	EC number	Concentration (%)	Reporting Limit (%)	Classification
1,2-Dichloroethane	107-06-2	203-458-1	N.D.	0.05	Carcinogenic
2,2'-dichloro-4,4'-methylenedianiline (MOCA)	101-14-4	202-918-9	N.D.	0.05	Carcinogenic
2-Methoxyaniline o-Anisidine	90-04-0	201-963-1	N.D.	0.05	Carcinogenic
4-(1,1,3,3-tetramethylbutyl)phenol, (4-tert-Octylphenol)	140-66-9	205-426-2	N.D.	0.05	Equivalent level of concern having probable serious effects to the environment
Aluminosilicate Refractory Ceramic Fibres* (RCF)	650-017-00-8 (Index no.)	-	N.D.	0.005	Carcinogenic
Arsenic acid*	7778-39-4	231-901-9	N.D.	0.005	Carcinogenic
Bis(2-methoxyethyl) ether	111-96-6	203-924-4	N.D.	0.05	Toxic for reproduction
Bis(2-methoxyethyl) phthalate	117-82-8	204-212-6	N.D.	0.05	Toxic for reproduction
Calcium arsenate*	7778-44-1	231-904-5	N.D.	0.005	Carcinogenic
Dichromium tris(chromate)*	24613-89-6	246-356-2	N.D.	0.005	Carcinogenic
Formaldehyde, oligomeric reaction products with aniline (technical MDA)	25214-70-4	500-036-1	N.D.	0.05	Carcinogenic
Lead diazide*	13424-46-9	236-542-1	N.D.	0.005	Toxic for reproduction
Lead dipicrate*	6477-64-1	229-335-2	N.D.	0.005	Toxic for reproduction
Lead styphnate*	15245-44-0	239-290-2	N.D.	0.005	Toxic for reproduction
N,N-dimethylacetamide (DMAC)	127-19-5	204-826-4	N.D.	0.05	Toxic for reproduction
Pentazinc chromate octahydroxide*	49663-84-5	256-418-0	N.D.	0.005	Carcinogenic
Phenolphthalein	77-09-8	201-004-7	N.D.	0.05	Carcinogenic
Potassium hydroxyoctaoxodizincatedichromate*	11103-86-9	234-329-8	N.D.	0.005	Carcinogenic
Trilead diarsenate*	3687-31-8	222-979-5	N.D.	0.005	Carcinogenic Toxic for reproduction
Zirconia Aluminosilicate Refractory Ceramic Fibres (Zr-RCF)*	650-017-00-8 (Index no.)	-	N.D.	0.005	Carcinogenic

This document is issued by the Company subject to its General Conditions of Service printed overleaf, available on request or accessible at <http://www.sgs.com/en/TermsandConditions.aspx> and, for electronic format documents, subject to Terms and Conditions for Electronic Documents at <http://www.sgs.com/en/e-documentation.htm>. Attention is drawn to the limitation of liability, indemnification and jurisdiction issues defined therein. Any holder of this document is advised that information contained herein reflects the Company's findings at the time of its observation only and within the limits of its' instructions. It is the Client's sole responsibility as to the Content and this document does not provide a guarantee or a warranty from or arising at the rights and obligations under the transaction documents. This document cannot be reproduced, stored in full, without prior written approval of the Company. Any unauthorized alteration, forgery or falsification of the content or appearance of the document is unlawful and offenders may be prosecuted to the fullest extent of the law. Unless otherwise stated the results shown in the test report refer only to the samples tested and such samples are retained for 90 days only.

F052 Version 5

SGS Korea Co., Ltd.

322, The Ovalley, 555-B, Hoge-dong, Dongan-gu, Anyang-si, Gyeonggi-do, Korea 431-090
t +82 (0)31 4608 000 f +82 (0)31 4608 050 <http://www.sgslab.co.kr> www.kr.sgs.com/greenlab

Member of the SGS Group (Société Générale de Surveillance)

Substance Name	CAS number	EC number	Concentration (%)	Reporting Limit (%)	Classification
1,2-bis(2-methoxyethoxy)ethane (TEGDME; triglyme)	112-49-2	203-977-3	N.D.	0.05	Toxic for reproduction
1,2-dimethoxyethane;ethylene glycol dimethyl ether (EGDME)	110-71-4	203-794-9	N.D.	0.05	Toxic for reproduction
Diboron trioxide*	1303-86-2	215-125-8	N.D.	0.005	Toxic for reproduction
Formamide	75-12-7	200-842-0	N.D.	0.05	Toxic for reproduction
Lead(II) bis(methanesulfonate)*	17570-76-2	401-750-5	N.D.	0.005	Toxic for reproduction
TGIC(1,3,5-tris(oxiranylmethyl)-1,3,5-triazine-2,4,6-(1H,3H,5H)-trione)	2451-62-9	219-514-3	N.D.	0.05	Mutagenic
β -TGIC (1,3,5-tris[(2S and 2R)-2,3-epoxypropyl]-1,3,5-triazine-2,4,6-(1H,3H,5H)-trione)**	59653-74-6	423-400-0	N.D.	0.05	Mutagenic
4,4'-bis(dimethylamino)benzophenone (Michler's ketone)	90-94-8	202-027-5	N.D.	0.05	Carcinogenic
N,N,N',N'-tetramethyl-4,4'-methylenedianiline (Michler's base)	101-61-1	202-959-2	N.D.	0.05	Carcinogenic
[4-[4,4'-bis(dimethylamino)benzhydrylidene]cyclohexa-2,5-dien-1-ylidene]dimethylammonium chloride (C.I. Basic Violet 3)	548-62-9	208-953-6	N.D.	0.05	Carcinogenic
[4-[[4-anilino-1-naphthyl][4-(dimethylamino)phenyl]methylenecyclohexa-2,5-dien-1-ylidene]dimethylammonium chloride (C.I. Basic Blue 26)	2580-56-5	219-943-6	N.D.	0.05	Carcinogenic
α,α -Bis[4-(dimethylamino)phenyl]-4(phenylamino)naphthalene-1-methanol (C.I. Solvent Blue 4)	6786-83-0	229-851-8	N.D.	0.05	Carcinogenic
4,4'-bis(dimethylamino)-4''-(methylamino)trityl alcohol	561-41-1	209-218-2	N.D.	0.05	Carcinogenic

This document is issued by the Company subject to its General Conditions of Sale (as printed overleaf, available on request or accessible at <http://www.sgs.com/en/TermsandConditions.aspx> and, for electronic format documents, subject to Terms and Conditions for Electronic Documents at www.sgs.com/etms_electronic.aspx. Attention is drawn to the limitation of liability, indemnification and jurisdiction issues defined therein. Any notice of this document's electronic format printed contained herein reflects the Company's findings at the time of its dissemination only and within the limits of valid instructions, if any. The Company's sole responsibility is to its Client and this document does not constitute parties to a transaction from as to which all their rights and obligations under the transaction documents. This document cannot be reproduced (except in full), without prior written approval of the Company. Any unauthorized alteration, forgery or falsification of the content or appearance of this document is unlawful and offenders may be prosecuted to the fullest extent of the law. Unless otherwise stated the results shown in this test report refer only to the sample(s) tested and such sample(s) are related to its/their only.

F052 Version 5

SGS Korea Co., Ltd.

322, The Ovalley, 555-9, Hoggys-dong, Dongan-gu, Anyang-si, Gyeonggi-do, Korea 431-080
t +82 (0)31 4608 000 f +82 (0)31 4608 059 <http://www.sgslab.co.kr> www.kr.sgs.com/greenlab

Member of the SGS Group (Société Générale de Surveillance)



Test Report No. F690101/LF-CTSAYAA12-41399 Issued Date: November 26, 2012 Page 9 of 14

The potential Substances

Substance Name	CAS number	EC number	Concentration (%)	Reporting Limit (%)	Classification
Bis(pentabromophenyl) ether (DecaBDE)	1163-19-5	214-604-9	N.D.	0.05	PBT vPvB
Pentacosafluorotridecanoic acid	72629-94-8	276-745-2	N.D.	0.05	vPvB
Tricosfluorododecanoic acid	307-55-1	206-203-2	N.D.	0.05	vPvB
Henicosfluoroundecanoic acid	2058-94-8	218-165-4	N.D.	0.05	vPvB
Heptacosfluorotetradecanoic acid	376-06-7	206-803-4	N.D.	0.05	vPvB
4-(1,1,3,3-tetramethylbutyl)phenol, ethoxylated - covering well-defined substances and UVCB substances, polymers and homologues	-	-	N.D.	0.05	Equivalent level of concern - probable serious effects on the environment
4-Nonylphenol, branched and linear - substances with a linear and/or branched alkyl chain with a carbon number of 9 covalently bound in position 4 to phenol, covering also UVCB- and well-defined substances which include any of the individual isomers or a combination thereof	-	-	N.D.	0.05	Equivalent level of concern - probable serious effects on the environment
Diazene-1,2-dicarboxamide (C,C'-azodi(formamide))	123-77-3	204-650-8	N.D.	0.05	Equivalent level of concern - probable serious effects on human health
Cyclohexane-1,2-dicarboxylic anhydride (Hexahydrophthalic anhydride - HHPA)	85-42-7	201-604-9	N.D.	0.05	Equivalent level of concern - probable serious effects on human health

The document is issued by the Company subject to its General Conditions of Service printed overleaf, available on request or accessible at <http://www.sgs.com/en/FormsandConditions.aspx> and, for electronic format documents, subject to Terms and Conditions for Electronic Documents at www.sgs.com/FormsandConditions.aspx. Attention is drawn to the limitation of liability, indemnification and jurisdiction issues defined therein. Any notice of this document is deemed to have been provided to the Client at the time of its dissemination only and within the limits of the Client's instructions, if any. The Company's sole responsibility is to its Client and this document does not constitute part of a transaction from which all their rights and obligations under the transaction documents. This document cannot be reproduced except in full, without prior written approval of the Company. Any unauthorised alteration, forgery or falsification of the content or appearance of this document is unlawful and offenders may be prosecuted to the fullest extent of the law. Unless otherwise stated the results shown in this test report refer only to the sample(s) tested and each sample(s) was tested for 30 days only.

F052 Version 5

SGS Korea Co., Ltd.

322, The Ovalley, 555-9, Hoggae-dong, Dongan-gu, Anyang-si, Gyeonggi-do, Korea 431-080
 t +82 (0)31 4608 000 f +82 (0)31 4608 059 <http://www.sgslab.co.kr> www.kr.sgs.com/csr/lab

Member of the SGS Group (Société Générale de Surveillance)

Substance Name	CAS number	EC number	Concentration (%)	Reporting Limit (%)	Classification
Hexahydromethylphthalic anhydride, Hexahydro-4-methylphthalic anhydride, Hexahydro-1-methylphthalic anhydride, Hexahydro-3-methylphthalic anhydride	25550-51-0, 19438-60-9, 48122-14-1, 57110-29-9	247-094-1, 243-072-0, 256-356-4, 260-566-1	N.D.	0.05	Equivalent level of concern - probable serious effects on human health
Methoxy acetic acid	625-45-6	210-894-6	N.D.	0.05	Toxic for reproduction equivalent level of concern -probable serious effects on human health and the environment
1,2-Benzenedicarboxylic acid, dipentylester, branched and linear	84777-06-0	284-032-2	N.D.	0.05	Toxic for reproduction
Diisopentylphthalate (DIPP)	605-50-5	210-088-4	N.D.	0.05	Toxic for reproduction
N-pentyl-isopentylphthalate	-	-	N.D.	0.05	Toxic for reproduction
1,2-Diethoxyethane	629-14-1	211-076-1	N.D.	0.05	Toxic for reproduction
N,N-dimethylformamide; dimethyl formamide	68-12-2	200-679-5	N.D.	0.05	Toxic for reproduction
Dibutyltin dichloride (DBT)	683-18-1	211-670-0	N.D.	0.05	Toxic for reproduction
Acetic acid, lead salt, basic*	51404-69-4	257-175-3	N.D.	0.005	Toxic for reproduction
Basic lead carbonate (trilead bis(carbonate)dihydroxide)*	1319-46-6	215-290-6	N.D.	0.005	Toxic for reproduction
Lead oxide sulfate (basic lead sulfate)*	12036-76-9	234-853-7	N.D.	0.005	Toxic for reproduction
[Phthalato(2-)]dioxotrilead (dibasic lead phthalate)*	69011-06-9	273-688-5	N.D.	0.005	Toxic for reproduction

This document is issued by the Company subject to its General Conditions of Service printed overleaf, available on request or accessible at <http://www.sgs.com/termsandconditions> and, for electronic format documents, subject to Terms and Conditions for Electronic Documents at www.sgs.com/termsandconditions. Attention is drawn to the limitation of liability, indemnification and jurisdiction issues defined therein. Any notice of this document is deemed to be received by the Client at the time of its submission only and within the limits of the Client's jurisdiction, if any. The Company's sole responsibility is to its Client and this document does not assume any liability to a third party from its acting all their rights and obligations under the transaction documents. This document cannot be reproduced except in full, without prior written approval of the Company. Any unauthorized alteration, forgery or falsification of the content or appearance of this document is unlawful and offenders may be prosecuted to the fullest extent of the law. Unless otherwise stated the results shown in this test report refer only to the sample(s) tested and such sample(s) are retained for 30 days only.

F052 Version 5

SGS Korea Co., Ltd.

322, The Ovalley, 555-9, Hogeje-dong, Dongan-gu, Anyang-si, Gyeonggi-do, Korea 431-080
t +82 (0)31 4608 000 f +82 (0)31 4608 050 <http://www.sgs.com> www.kr.sgs.com sgs@sgs.com

Member of the SGS Group (Société Générale de Surveillance)

Substance Name	CAS number	EC number	Concentration (%)	Reporting Limit (%)	Classification
Dioxobis(stearato)trilead*	12578-12-0	235-702-8	N.D.	0.005	Toxic for reproduction
Fatty acids, C16-18, lead salts*	91031-62-8	292-966-7	N.D.	0.005	Toxic for reproduction
Lead bis(tetrafluoroborate)*	13814-96-5	237-486-0	N.D.	0.005	Toxic for reproduction
Lead cyanamidate*	20837-86-9	244-073-9	N.D.	0.005	Toxic for reproduction
Lead dinitrate*	10099-74-8	233-245-9	N.D.	0.005	Toxic for reproduction
Lead oxide (lead monoxide)*	1317-36-8	215-267-0	N.D.	0.005	Toxic for reproduction
Lead tetroxide (orange lead)*	1314-41-6	215-235-6	N.D.	0.005	Toxic for reproduction
Lead titanium trioxide*	12060-00-3	235-038-9	N.D.	0.005	Toxic for reproduction
Lead Titanium Zirconium Oxide*	12626-81-2	235-727-4	N.D.	0.005	Toxic for reproduction
Pentalead tetraoxide sulphate*	12065-90-6	235-067-7	N.D.	0.005	Toxic for reproduction
Pyrochlore, antimony lead yellow*	8012-00-8	232-382-1	N.D.	0.005	Toxic for reproduction
Silicic acid, barium salt, lead-doped*	68784-75-8	272-271-5	N.D.	0.005	Toxic for reproduction
Silicic acid, lead salt*	11120-22-2	234-363-3	N.D.	0.005	Toxic for reproduction
Sulfurous acid, lead salt, dibasic*	62229-08-7	263-467-1	N.D.	0.005	Toxic for reproduction
Tetraethyllead*	78-00-2	201-075-4	N.D.	0.005	Toxic for reproduction
Tetralead trioxide sulphate*	12202-17-4	235-380-9	N.D.	0.005	Toxic for reproduction

This document is issued by the Company subject to its General Conditions of Service printed overleaf, available on request or accessible at http://www.sgs.com/en/TermsandConditions_sgs.pdf, and for electronic format documents, subject to Terms and Conditions for Electronic Documents at www.sgs.com/terms_electronic_sgs. Attention is drawn to the limitation of liability, indemnification and jurisdiction issues defined therein. Any notice of this document is deemed to be given to the Client at the time of its placement only and within the limits of valid instructions, if any. The Company's sole responsibility is to its Client and this document does not assume liability to a transaction from its clients all their rights and obligations under the transaction documents. This document cannot be reproduced (except in full), without prior written approval of the Company. Any unauthorised alteration, forgery or falsification of the content or appearance of this document is unlawful and offenders may be prosecuted to the fullest extent of the law. Unless otherwise stated the results shown in this test report refer only to the sample(s) tested and each sample(s) was tested for its design only.

F052 Version 5

SGS Korea Co., Ltd.

322, The Ovalley, 555-9, Hoggys-dong, Dongan-gu, Anyang-si, Gyeonggi-do, Korea 431-080
t +82 (0)31 4608 000 f +82 (0)31 4608 050 <http://www.sgslab.co.kr> www.kr.sgs.com/greenlab

Member of the SGS Group (Société Générale de Surveillance)

Substance Name	CAS number	EC number	Concentration (%)	Reporting Limit (%)	Classification
Trilead dioxide phosphonate*	12141-20-7	235-252-2	N.D.	0.005	Toxic for reproduction
Furan	110-00-9	203-727-3	N.D.	0.05	Carcinogenic
Propylene oxide; 1,2-epoxypropane; methyloxirane	75-56-9	200-879-2	N.D.	0.05	Carcinogenic Mutagenic
Diethyl sulphate	64-67-5	200-589-6	N.D.	0.05	Carcinogenic Mutagenic
Dimethyl sulphate	77-78-1	201-058-1	N.D.	0.05	Carcinogenic
3-ethyl-2-methyl-2-(3-methylbutyl)-1,3-oxazolidine	143860-04-2	421-150-7	N.D.	0.05	Toxic for reproduction
Dinoseb	88-85-7	201-861-7	N.D.	0.05	Toxic for reproduction
4,4'-methylenedi-o-toluidine	838-88-0	212-658-8	N.D.	0.05	Carcinogenic
4,4'-oxydianiline and its salts	101-80-4	202-977-0	N.D.	0.05	Carcinogenic Mutagenic
4-Aminoazobenzene; 4-Phenylazoaniline	60-09-3	200-453-6	N.D.	0.05	Carcinogenic
4-methyl-m-phenylenediamine (2,4-toluene-diamine)	95-80-7	202-453-1	N.D.	0.05	Carcinogenic
6-methoxy-m-toluidine (p-cresidine)	120-71-8	204-419-1	N.D.	0.05	Carcinogenic
Biphenyl-4-ylamine	92-67-1	202-177-1	N.D.	0.05	Carcinogenic
o-aminoazotoluene	97-56-3	202-591-2	N.D.	0.05	Carcinogenic
o-Toluidine; 2-Aminotoluene	95-53-4	202-429-0	N.D.	0.05	Carcinogenic
N-methylacetamide	79-16-3	201-182-6	N.D.	0.05	Toxic for reproduction
1-bromopropane; n-propyl bromide	106-94-5	203-445-0	N.D.	0.05	Toxic for reproduction

This document is issued by the Company subject to its General Conditions of Service printed overleaf, available on request or accessible at <http://www.sgs.com/en/Terms-and-Conditions.aspx> and, for electronic format documents, subject to Terms and Conditions for Electronic Documents at www.sgs.com/usa/electronic.htm. Attention is drawn to the limitation of liability, indemnification and jurisdiction issues defined therein. Any notice of this document is deemed to have been provided to the Client at the time of its download only and under the terms of said instructions. It is the Client's sole responsibility as to its Client and this document does not assume liability to a transaction from its issuing all their rights and obligations under the transaction documents. This document cannot be reproduced except in full, without prior written approval of the Company. Any unauthorised alteration, forgery or falsification of the content or appearance of this document is unlawful and offenders may be prosecuted to the fullest extent of the law.

F052 Version 5

SGS Korea Co., Ltd.

322, The Chivalley, 555-9, Hoggae-dong, Dongan-gu, Anyang-si, Gyeonggi-do, Korea 431-080
t +82 (0)31 4608 000 f +82 (0)31 4608 059 <http://www.sgslab.co.kr> www.kr.sgs.com/crsenlab

Member of the SGS Group (Société Générale de Surveillance)



Test Report No. F690101/LF-CTSAYAA12-41399 Issued Date: November 26, 2012 Page 13 of 14

Note:

1. RL = Reporting Limit
2. N.D. = Not detected (lower than RL)

N.A. = Not applicable for respective material type.

The submitted sample was found to contain significant amount of specific element(s) of SVHC. Upon further test verification and also information provided from client, the possibility that the element(s) content originate from SVHC is very unlikely, even though their presence cannot be exclude entirely. It may be assumed that the detected element(s) have a non-SVHC source.

3. Definition of classification is listed in Appendix A of this report in accordance with 67/548/EEC and Regulation (EC) No 1907/2006. For detail information, Detail explanation is available at the following link:

<http://echa.europa.eu/web/guest/candidate-list-table> (Candidate list)
http://echa.europa.eu/en/web/guest/view-article/-/journal_content/512b7526-9dd6-4872-934e-8c298c89ad99
 (Potential list)

4. *.The test result is based on the calculation of selected element(s) / marker(s) and to the worst-case scenario. For detail information, please refer to the SGS REACH website: www.reach.sgs.com/substance-of-very-high-concern-analysis-information-page.htm

The client is advised to review the chemical formulation to ascertain above metal substances present in the article.
 RL = 0.005% is evaluated for element (i.e. cobalt, arsenic, lead, sodium, chromium, chromium(VI), silicon, aluminum, zirconium, boron, and potassium respectively), except molybdenum RL=0.0005%

0.1% (w/w) = 1,000 ppm = 1,000 mg/kg

5. **.β-TGIC is one of the isomers for TGIC compounds and hence, tested together. The reported test result is based the proposed ratio as according to ECHA dossier.

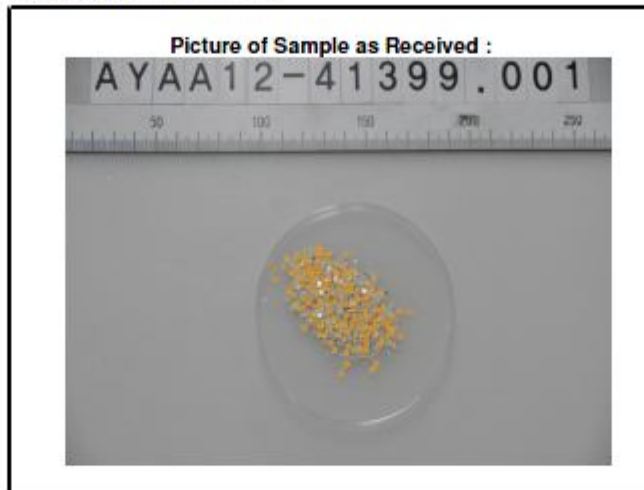

*** End of Report ***

This document is issued by the Company subject to its General Conditions of Sale (as printed overleaf, available on request or accessible at http://www.sgs.com/en/Terms-and-Conditions_sgs.pdf), for electronic format documents, subject to Terms and Conditions for Electronic Documents at www.sgs.com/terms_electronic_docs. Attention is drawn to the limitation of liability, indemnification and jurisdiction issues defined therein. Any notice of this document is deemed to be of primary concern contained herein reflects the Company's findings at the time of its issuance only and within the limits of SGS's instructions. It is the Client's sole responsibility as to its Client and this document does not assume parties to a transaction from as stating all their rights and obligations under the transaction documents. This document cannot be reproduced (except in full), without prior written approval of the Company. Any unauthorized alteration, forgery or falsification of the content or appearance of this document is unlawful and offenders may be prosecuted to the fullest extent of the law. Unless otherwise stated the results shown in this test report refer only to the sample(s) tested and such sample(s) are retained for 90 days only.

Appendix A

Classification	Definition under 67/548/EEC and Regulation (EC) No 1907/2006
Carcinogen Category 1:	<u>Substances known to be carcinogenic to man.</u> There is sufficient evidence to establish a causal association between human exposure to a substance and the development of cancer.
Carcinogen Category 2:	<u>Substances which should be regarded as if they are carcinogenic to man.</u> There is sufficient evidence to provide a strong presumption that human exposure to a substance may result in the development of cancer. Generally on the basis of: - appropriate long-term animal studies - other relevant information.
Mutagen Category 1:	<u>Substances known to be mutagenic to man.</u> There is sufficient evidence to establish a causal association between human exposure to a substance and heritable genetic damage.
Mutagen Category 2:	<u>Substances which should be regarded as if they are mutagenic to man.</u> There is sufficient evidence to provide a strong presumption that human exposure to the substance may result in the development of heritable genetic damage, generally on the basis of: - appropriate animal studies, - other relevant information.
Toxic to Reproduction Category 1:	<u>Substances known to impair fertility in humans.</u> There is sufficient evidence to establish a causal relationship between human exposure to the substance and impaired fertility. <u>Substances known to cause developmental toxicity in humans.</u> There is sufficient evidence to establish a causal relationship between human exposure to the substance and subsequent developmental toxic effects in the progeny.
Toxic to Reproduction Category 2:	<u>Substances which should be regarded as if they impair fertility in humans.</u> There is sufficient evidence to provide a strong presumption that human exposure to the substance may result in impaired fertility on the basis of: - clear evidence in animal studies of impaired fertility in the absence of toxic effects, or, evidence of impaired fertility occurring at around the same dose levels as other toxic effects but which is not a secondary nonspecific consequence of the other toxic effects, - other relevant information. <u>Substances which should be regarded as if they cause developmental toxicity to humans.</u> There is sufficient evidence to provide a strong presumption that human exposure to the substance may result in developmental toxicity, generally on the basis of: - clear results in appropriate animal studies where effects have been observed in the absence of signs of marked maternal toxicity, or at around the same dose levels as other toxic effects but which are not a secondary non-specific consequence of the other toxic effects, - other relevant information.
PBT & vPvB:	Substances which are persistent, bioaccumulative and toxic (PBT) or very persistent and very bioaccumulative (vPvB) pose a particular challenge to the chemicals safety management. For these substances a "safe" concentration in the environment cannot be established with sufficient reliability.

This document is issued by the Company subject to its General Conditions of Service printed overleaf, available on request or accessible at <http://www.sgs.com/en/Terms-and-Conditions.aspx> and, for electronic format documents, subject to Terms and Conditions for Electronic Documents at www.sgs.com/Forms/electronic-forms. Attention is drawn to the limitation of liability, indemnification and jurisdiction issues defined therein. Any notice of this document is deemed to be received by the Client at the time of its dissemination only and within the limits of the Client's instructions, if any. The Company's sole responsibility is to its Client and this document does not assume any liability to a third party in a transaction from which all their rights and obligations under the transaction documents. This document cannot be reproduced except in full, without prior written approval of the Company. Any unauthorized alteration, forgery or falsification of the content or appearance of this document is unlawful and offenders may be prosecuted to the fullest extent of the law. Unless otherwise stated the results shown in this test report refer only to the sample(s) tested and such sample(s) are indicated on the report only.

F052 Version 5

SGS Korea Co., Ltd.

322, The Ovalley, 555-9, Hoggae-dong, Dongan-gu, Anyang-si, Gyeonggi-do, Korea 431-080
t +82 (0)31 4608 000 f +82 (0)31 4608 059 [Http://www.sgsksh.com](http://www.sgsksh.com) www.kr.sgs.com/presslab

Member of the SGS Group (Società Generale da Sorveglianza)

Revision History

Date	NO	Revision History	Writer																																																																							
			Drawn	Approved																																																																						
2013.02.14	001	New version	T.J KIM	Y.T KIM																																																																						
2013.04.08	002	6500K, 5700K, 5000K CIE 8분할 적용	T.J KIM	Y.T KIM																																																																						
2013.07.27	003	<p>전 CCT IV spec 변경(LM231A와 통일)</p> <table border="1" style="width: 100%; border-collapse: collapse;"> <tr> <th colspan="3">기존</th> <th style="font-size: 2em; color: blue;">➔</th> <th colspan="3">변경</th> </tr> <tr> <td>bin</td><td>Min</td><td>Max</td> <td></td> <td>bin</td><td>Min</td><td>Max</td> </tr> <tr> <td>SY</td><td>22.00</td><td>24.50</td> <td></td> <td>S1</td><td>20.55</td><td>23.56</td> </tr> <tr> <td>SZ</td><td>24.50</td><td>27.00</td> <td></td> <td>S2</td><td>23.56</td><td>27.09</td> </tr> <tr> <td>S1</td><td>27.00</td><td>29.00</td> <td></td> <td>S3</td><td>27.09</td><td>31.16</td> </tr> </table> <table border="1" style="width: 100%; border-collapse: collapse;"> <tr> <th colspan="3">기존</th> <th style="font-size: 2em; color: blue;">➔</th> <th colspan="3">변경</th> </tr> <tr> <td>bin</td><td>Min</td><td>Max</td> <td></td> <td>bin</td><td>Min</td><td>Max</td> </tr> <tr> <td>SY</td><td>19.00</td><td>21.50</td> <td></td> <td>S1</td><td>19.81</td><td>22.78</td> </tr> <tr> <td>SZ</td><td>21.50</td><td>24.00</td> <td></td> <td>S2</td><td>22.78</td><td>26.20</td> </tr> <tr> <td>S1</td><td>24.00</td><td>26.00</td> <td></td> <td>S3</td><td>26.20</td><td>30.13</td> </tr> </table>	기존			➔	변경			bin	Min	Max		bin	Min	Max	SY	22.00	24.50		S1	20.55	23.56	SZ	24.50	27.00		S2	23.56	27.09	S1	27.00	29.00		S3	27.09	31.16	기존			➔	변경			bin	Min	Max		bin	Min	Max	SY	19.00	21.50		S1	19.81	22.78	SZ	21.50	24.00		S2	22.78	26.20	S1	24.00	26.00		S3	26.20	30.13	T.J KIM	Y.T KIM
기존			➔	변경																																																																						
bin	Min	Max		bin	Min	Max																																																																				
SY	22.00	24.50		S1	20.55	23.56																																																																				
SZ	24.50	27.00		S2	23.56	27.09																																																																				
S1	27.00	29.00		S3	27.09	31.16																																																																				
기존			➔	변경																																																																						
bin	Min	Max		bin	Min	Max																																																																				
SY	19.00	21.50		S1	19.81	22.78																																																																				
SZ	21.50	24.00		S2	22.78	26.20																																																																				
S1	24.00	26.00		S3	26.20	30.13																																																																				
2013.09.23	004	Addition of UL Authentication	J.H.YUN	Y.T KIM																																																																						
2013.10.28	005	Addition of Kitting combination Modification of CIE tolerance	T.J KIM	Y.T KIM																																																																						
2014.01.06	006	Addition of Quarter of color binning	T.J KIM	Y.T KIM																																																																						